

# MHI

## SERVICE MANUAL

### INVERTER MULTI-SPLIT SYSTEM RESIDENTIAL AIR CONDITIONERS (Split system, air to air heat pump type)

#### (OUTDOOR UNIT)

SCM40ZJ-S  
SCM45ZJ-S  
SCM50ZJ-S  
SCM60ZJ-S  
SCM71ZJ-S  
SCM80ZJ-S

#### (INDOOR UNIT)

##### Wall mounted type

SRK20ZJX-S  
SRK25ZJX-S  
SRK35ZJX-S  
SRK50ZJX-S  
SRK60ZJX-S  
SRK20ZJ-S  
SRK25ZJ-S  
SRK35ZJ-S  
SRK50ZJ-S

##### Floor standing type

SRF25ZJX-S  
SRF35ZJX-S  
SRF50ZJX-S

##### Ceiling concealed type

SRR25ZJ-S  
SRR35ZJ-S  
SRR50ZJ-S  
SRR60ZJ-S

##### Ceiling cassette-4way compact type

FDTC25VD  
FDTC35VD  
FDTC50VD  
FDTC60VD

 **MITSUBISHI HEAVY INDUSTRIES, LTD.**



Большая библиотека технической документации  
<http://splitoff.ru/tehn-doc.html>  
каталоги, инструкции, сервисные мануалы, схемы.

## CONTENTS

<b>1. OUTLINE OF OPERATION CONTROL BY MICROCOMPUTER</b>	<b>5</b>
<b>1.1 SRK,SRF and SRR series</b>	<b>5</b>
(1) Operation control function by remote controller	5
(2) Unit ON/OFF button	8
(3) Auto restart function	9
(4) Custom cord switching procedure	9
(5) Flap and louver control	10
(6) Air outlet selection (SRF series only)	12
(7) 3D auto operation (SRK series only)	12
(8) Timer operation	13
(9) Installation location setting (SRK series only)	14
(10) Determining the operating mode	14
(11) Drain motor (DM) control (SRR series only)	15
<b>1.2 FDTC series</b>	<b>16</b>
(1) Remote controller (Option parts)	16
(2) Operation control function by the wired remote controller	18
(3) Operation control function by the indoor controller	19
<b>1.3 Outline of heating operation</b>	<b>28</b>
(1) Summary	28
(2) Operation of major functional components in heating mode	28
(3) Hot keep operation	28
(4) Defrosting operation	29
<b>1.4 Outline of cooling operation</b>	<b>30</b>
(1) Summary	30
(2) Operation of major functional components in cooling mode	30
<b>1.5 Outline of automatic operation</b>	<b>30</b>
(1) SRK20~60ZJX-S,SRF and SRR series	30
(2) SRK20~60ZJ-S series	31
(3) FDTC series	31
<b>1.6 Operation permission/prohibition control</b>	<b>32</b>
(1) The operation mode is switched over between Permission and Prohibition by releasing the jumper wire (J3) on the indoor PCB	32
(2) In the case of CnT input ON (Operation permission)	32
(3) In the case of CnT input OFF (Operation prohibition)	32



<b>1.7 External control (remote display)/control of input signal</b>	<b>32</b>
(1) External control (remote display) output	32
(2) Control of input signal	32
<b>1.8 Protective control function</b>	<b>33</b>
(1) Frost prevention control	33
(2) Cooling overload protective control	33
(3) Cooling high pressure control	34
(4) Cooling low outdoor temperature protective control	34
(5) Heating high pressure control	35
(6) Heating overload protective control	35
(7) Heating low outdoor temperature protective control	36
(8) Freezing cycle system protective control	36
(9) Crankcase heater	36
(10) Inching prevention	37
(11) Compressor overheat protection	37
(12) Current safe	37
(13) Current cat	38
(14) Outdoor unit failure	38
(15) Indoor fan motor protection	38
(16) Discharge pipe sensor disconnection protection control	38
(17) Regulation of outdoor air flow	38
(18) Serial signal transmission error protection	39
(19) Rotor lock	39
(20) Outdoor fan motor protection	39
(21) Outdoor fan control at low outdoor temperature	39
(22) Outdoor unit fan control at overload	40
<b>2. MAINTENANCE DATA</b>	<b>41</b>
<b>2.1 SRK,SRF and SRR series</b>	<b>41</b>
(1) Cautions	41
(2) Items to check before troubleshooting	41
(3) Troubleshooting procedure (If the air conditioner does not run at all)	41
(4) Troubleshooting procedure (If the air conditioner runs)	42
(5) Self-diagnosis table	43
(6) Service mode (Trouble mode access function)	44
(7) Inspection procedures corresponding to detail of trouble	52
(8) Phenomenon observed after shortcircuit, wire breakage on sensor	56

(9) Checking the indoor electrical equipment .....	57
(10) How to make sure of wireless remote controller .....	58
(11) Outdoor unit inspection points .....	59
<b>2.2 FDTC series .....</b>	<b>63</b>
<b>2.2.1 Diagnosing of microcomputer circuit .....</b>	<b>63</b>
(1) Selfdiagnosis function .....	63
(2) Troubleshooting procedure .....	66
(3) Troubleshooting at the indoor unit .....	66
(4) Check of anomalous operation data with the remote controller .....	70
(5) Inverter checker for diagnosis of inverter output .....	71
(6) Outdoor unit inspection points .....	72
<b>2.2.2 Troubleshooting flow .....</b>	<b>75</b>
(1) List of troubles .....	75
(2) Troubleshooting .....	76
<b>3. ELECTRICAL WIRINGS .....</b>	<b>116</b>
<b>3.1 Outdoor units .....</b>	<b>116</b>
<b>3.2 Indoor units .....</b>	<b>119</b>
<b>4. PIPING SYSTEMS .....</b>	<b>124</b>
<b>5. APPLICATION DATAS .....</b>	<b>127</b>
<b>5.1 Installation of outdoor unit .....</b>	<b>127</b>
(1) Models SCM40ZJ-S,45ZJ-S .....	127
(2) Models SCM50ZJ-S,60ZJ-S .....	131
(3) Models SCM71ZJ-S,80ZJ-S .....	135
<b>5.2 Installation of indoor unit .....</b>	<b>139</b>
(1) Wall mounted type (SRK) .....	139
(2) Floor standing type (SRF) .....	147
(3) Ceiling concealed type (SRR) .....	151
(4) Ceiling cassette-4way compact type (FDTC) .....	155

## Table of models

Model \ Capacity	20	25	35	50	60
Wall mounted type (SRK-ZJX-S)	○	○	○	○	○
Wall mounted type (SRK-ZJ-S)	○	○	○	○	
Floor standing type (SRF)		○	○	○	
Ceiling concealed type (SRR)		○	○	○	○
Ceiling cassette-4way compact type (FDTC)		○	○	○	○
Outdoor unit to be combined (SCM)	SCM40ZJ-S,45ZJ-S,50ZJ-S,60ZJ-S,71ZJ-S,80ZJ-S				

## How to read the model name

### Indoor unit

Example: **SRK 20 Z JX-S**

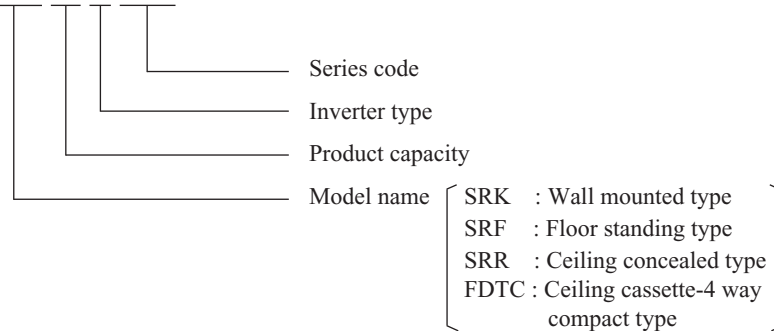

### Outdoor unit

Example: **SCM 60 Z J-S**

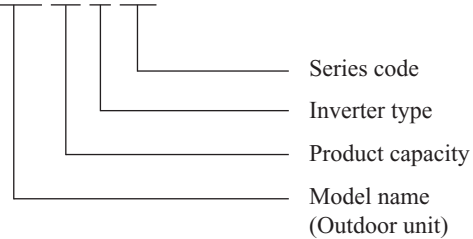

# 1 OUTLINE OF OPERATION CONTROL BY MICROCOMPUTER

## 1.1 SRK, SRF and SRR series

### (1) Operation control function by remote control

#### Remote controller

#### SRK series

##### ◆ Operation section

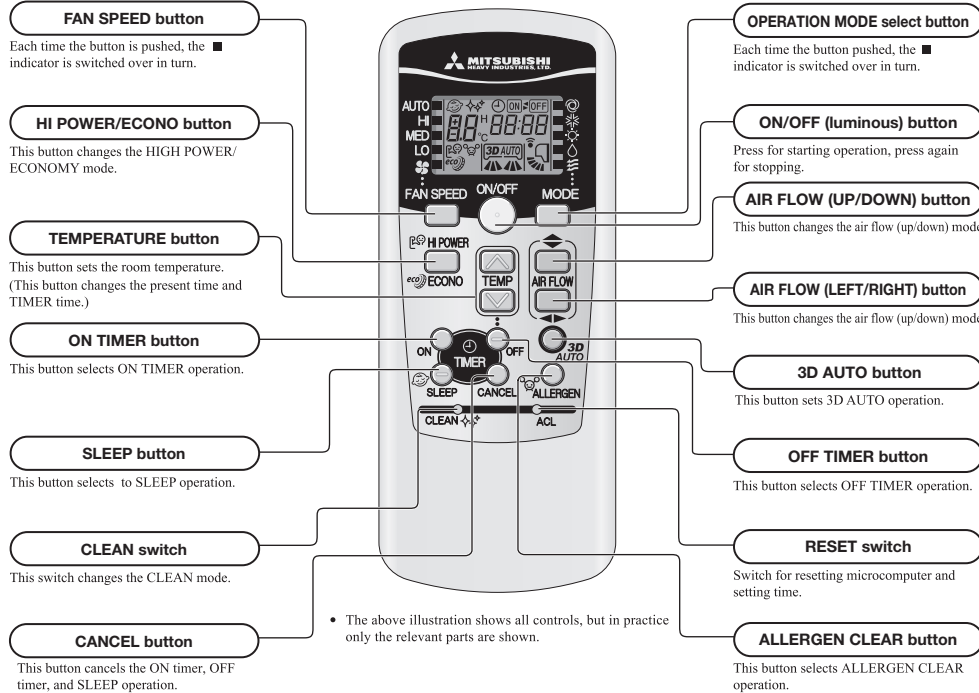

#### SRF series

##### ◆ Operation section

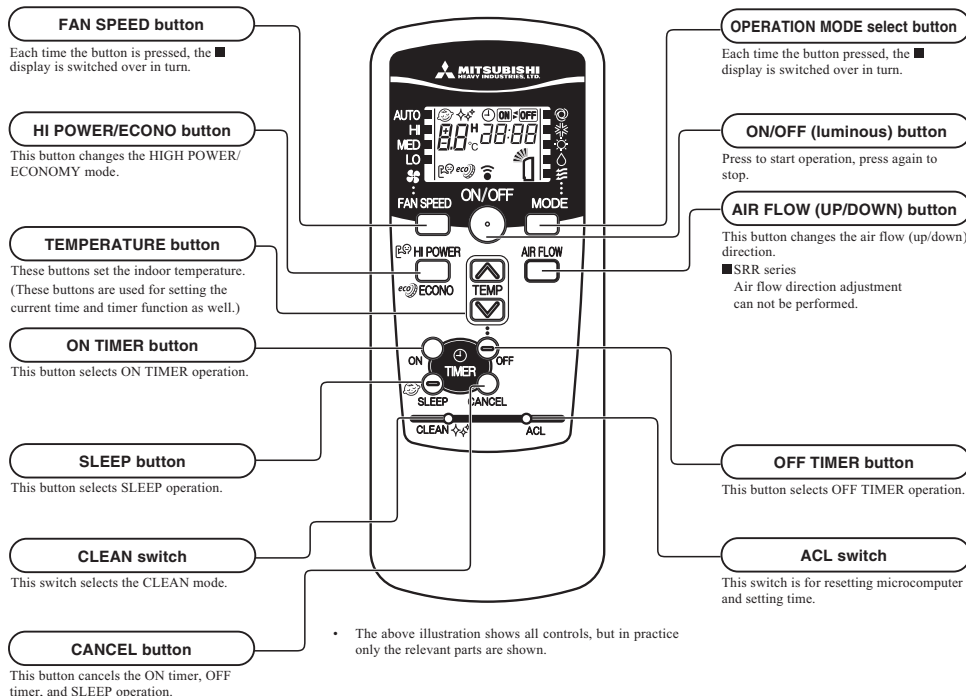

## SRR series

### ◆ Operation section

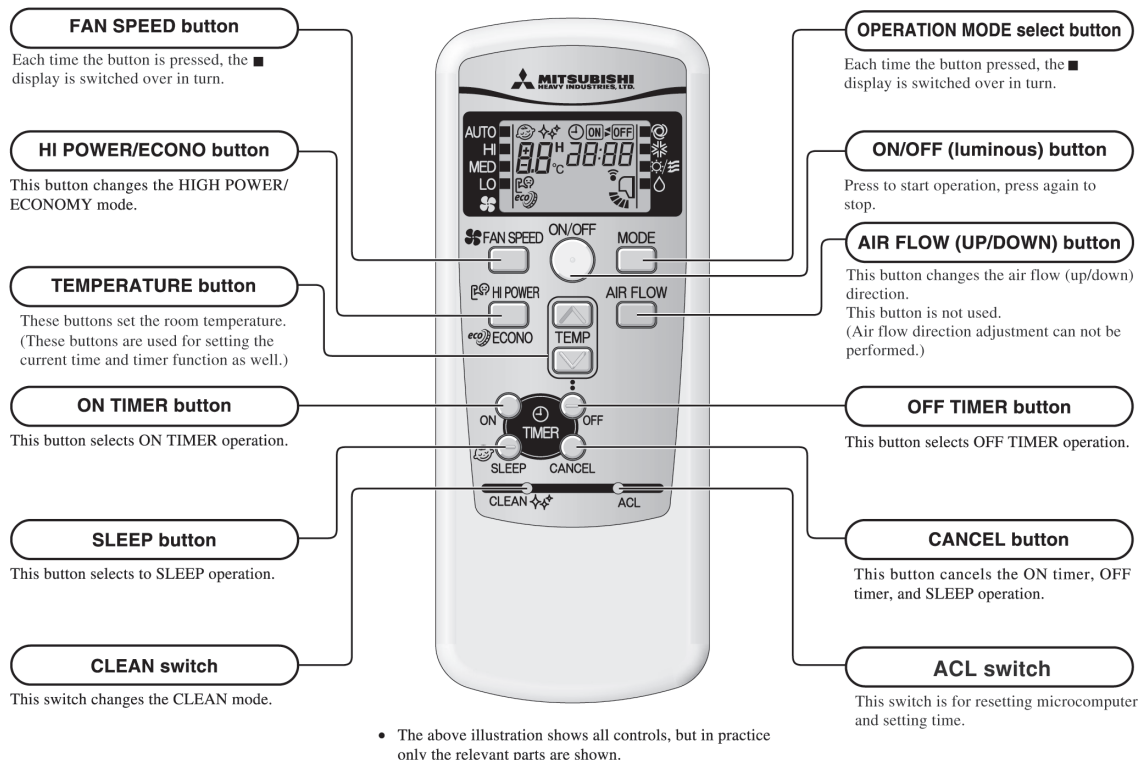

### Unit indication section

#### Model SRK20-60ZJX-S

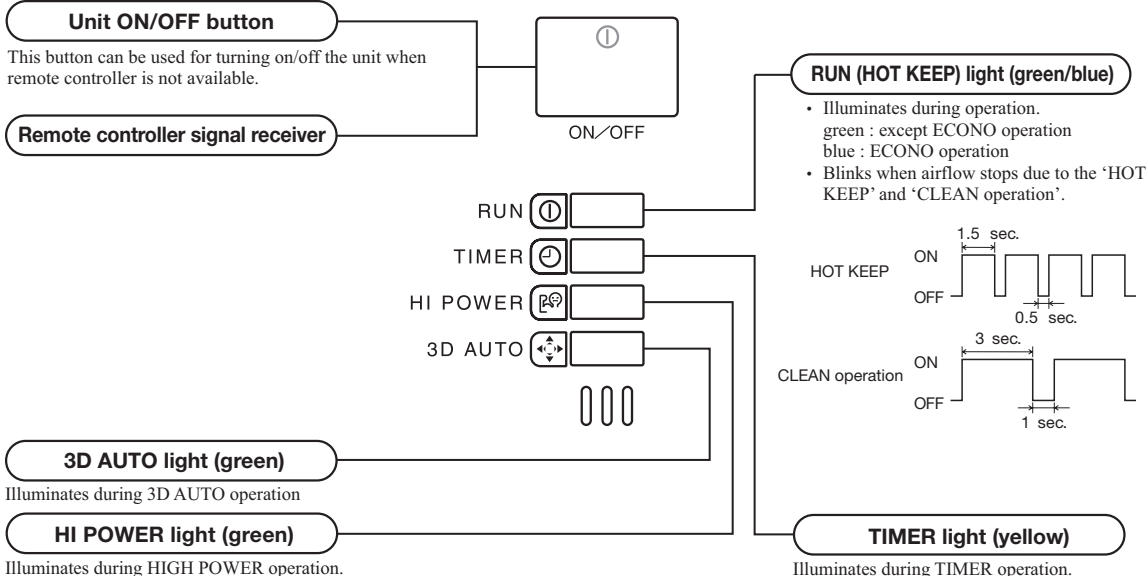

**Model SRK20~50ZJ-S**

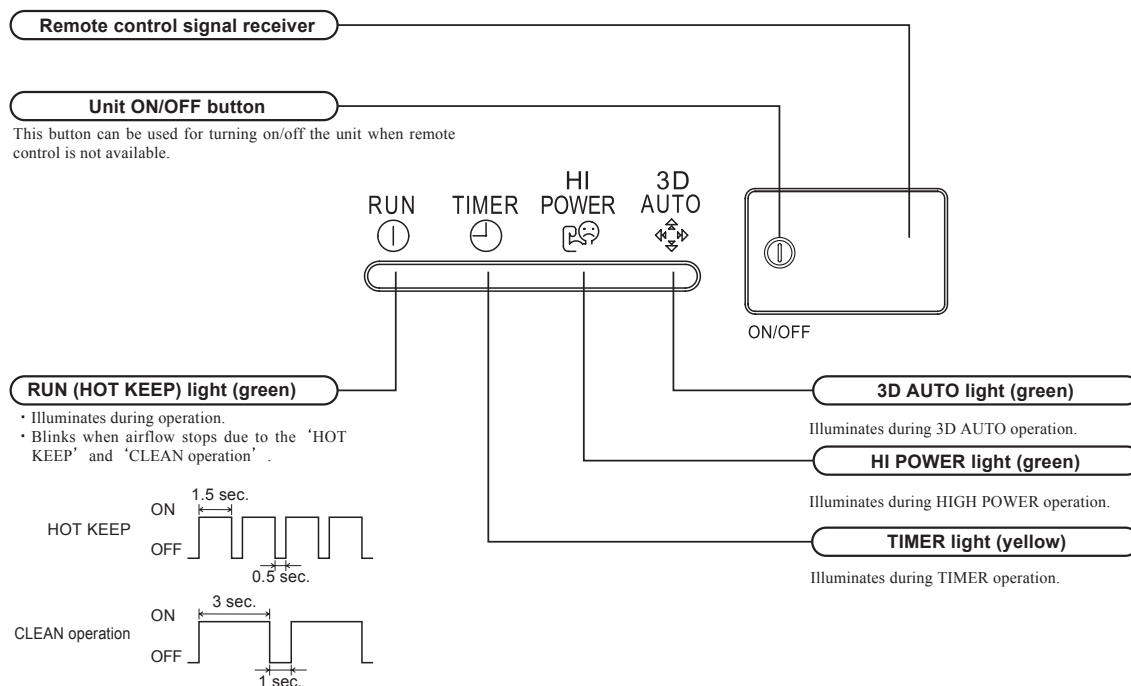

**Model SRF25~50ZJX-S**

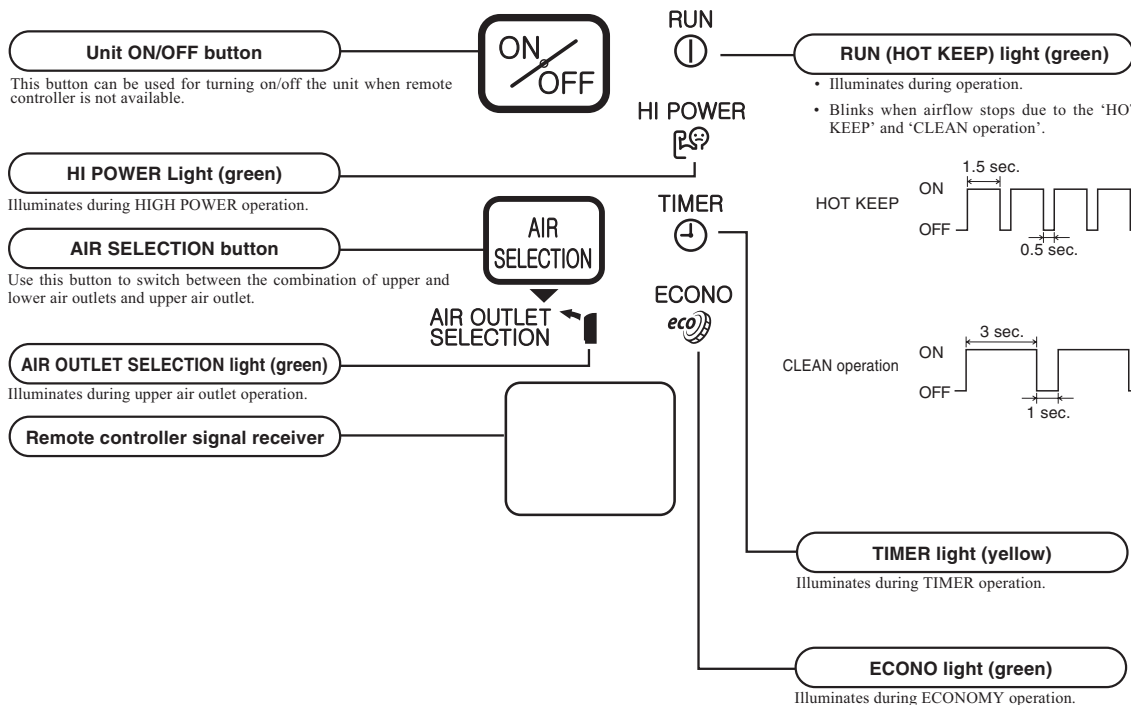

**Model SRR25~60ZJ-S**

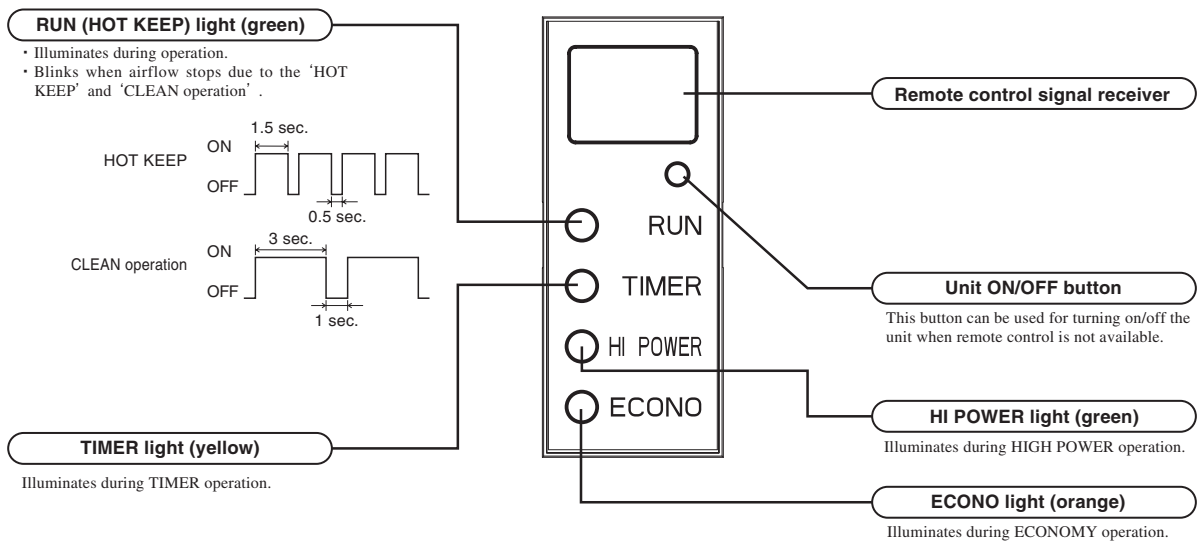

**(2) Unit ON/OFF button**

When the remote controller batteries become weak, or if the remote controller is lost or malfunctioning, this button may be used to turn the unit on and off.

**(a) Operation**

Push the button once to place the unit in the automatic mode. Push it once more to turn the unit off.

**(b) Details of operation**

The unit will go into the automatic mode in which it automatically determines, from indoor temperature (as detected by sensor), whether to go into the cooling, thermal dry or heating modes.

Function operation mode	Indoor temperature setting	Fan speed	Flap/Louver	Timer Switch
<b>Cooling</b>	About 24°C	Auto	Auto	Continuous
<b>Thermal dry</b>	About 25°C			
<b>Heating</b>	About 26°C			

• Model SRK20~60ZJX-S

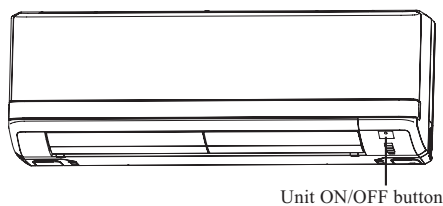

• Model SRK20~50ZJ-S

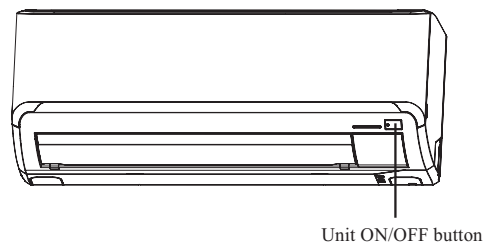

• Model SRF25~50ZJX-S

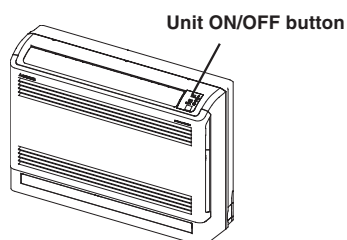

• Model SRR25~60ZJ-S

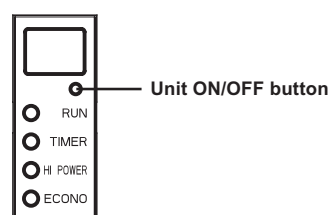

### (3) Auto restart function

- (a) Auto restart function records the operational status of the air-conditioner immediately prior to be switched off by a power cut, and then automatically resumes operations after the power has been restored.
- (b) The following settings will be cancelled:
  - 1) Timer settings
  - 2) HIGH POWER operations

Notes (1) Auto restart function is set at on when the air-conditioner is shipped from the factory. Consult with your dealer if this function needs to be switched off.  
 (2) When power failure occurs, the timer setting is cancelled. Once power is resumed, reset the timer.  
 (3) If the jumper wire (J170 or JA1) "AUTO RESTART" is cut, auto restart is disabled. (See the diagram at right)

• Model SRK20~60ZJX-S  
 SRF25~50ZJX-S  
 SRR25~60ZJ-S

• Model SRK20~50ZJ-S

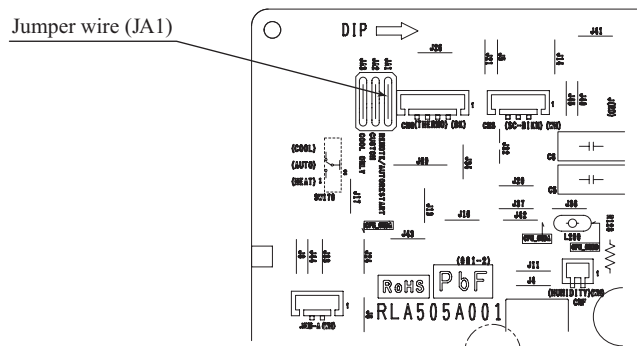
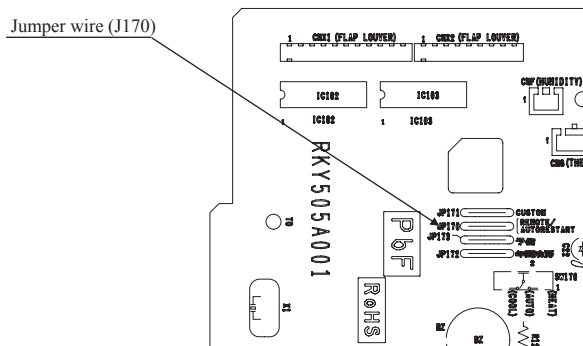

### (4) Custom cord switching procedure

If two wireless remote controller are installed in one room, in order to prevent wrong operation due to mixed signals, please modify the printed circuit board in the indoor unit's controlbox and the remote controller using the following procedure.  
 Be sure to modify both boards. If only one board is modified, receiving (and operation) cannot be done.

#### (a) Modifying the indoor printed circuit board

Take out the printed circuit board from the control box and cut off jumper wire (J171 or JA2) using wire cutters.  
 After cutting of the jumper wire, take measures to prevent contact with the other the lead wires, etc.

• Model SRK20~60ZJX-S  
 SRF25~50ZJX-S  
 SRR25~60ZJ-S

• Model SRK20~50ZJ-S

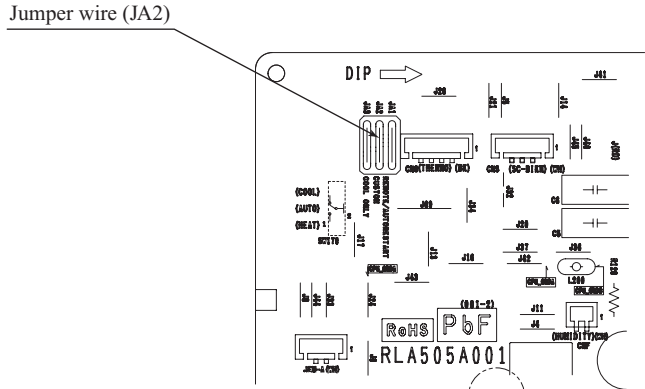
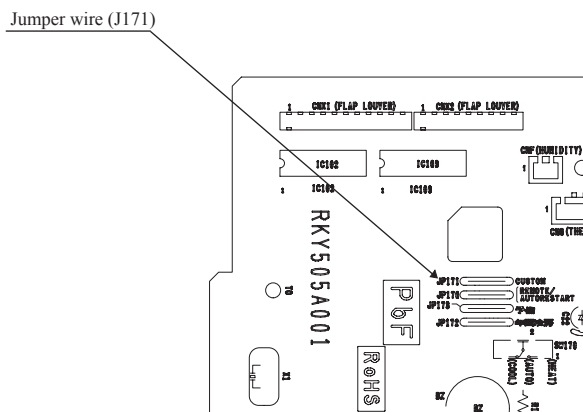



**(b) Modifying the wireless remote controller**

- 1) Remove the battery.
- 2) Cut the jumper wire shown in the figure at right.

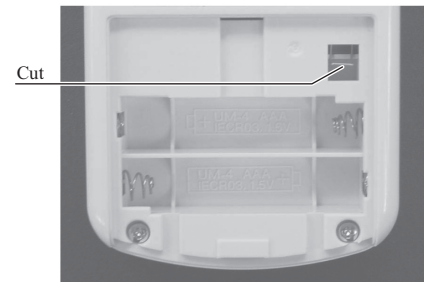

**(5) Flap and louver control (SRK and SRF series only)**

◆ **SRK series**

Control the flap and louver by AIRFLOW (UP/DOWN) and (LEFT/RIGHT) button on the wireless remote controller.

**(a) Flap**

Each time when you press the AIRFLOW (UP/DOWN) button the mode changes as follows.

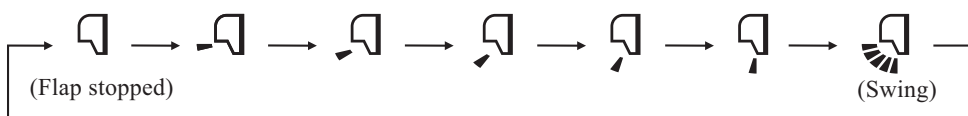

• Angle of Flap from Horizontal  
**Mode SRK20~60ZJX-S**

<b>Remote controller display</b>					
<b>COOL , DRY, FAN</b>	Approx. 5°	Approx. 20°	Approx. 35°	Approx. 45°	Approx. 60°
<b>HEAT</b>	Approx. 20°	Approx. 35°	Approx. 45°	Approx. 60°	Approx. 75°

**Model SRK20~50ZJ-S**

<b>Remote controller display</b>					
<b>COOL , DRY, FAN</b>	Approx. 10°	Approx. 25°	Approx. 40°	Approx. 50°	Approx. 60°
<b>HEAT</b>	Approx. 25°	Approx. 40°	Approx. 50°	Approx. 60°	Approx. 70°

**(b) Louver**

Each time when you press the AIRFLOW (LEFT/RIGHT) button the mode changes as follows.

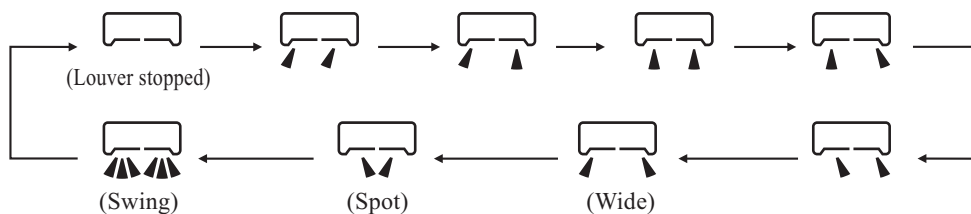

• Angle of Louver

<b>Remote controller display</b>					
<b>Center installation</b>	Left Approx. 50°	Left Approx. 20°	Center	Right Approx. 20°	Right Approx. 50°
<b>Right end installation</b>	Left Approx. 50°	Left Approx. 45°	Left Approx. 30°	Center	Right Approx. 20°
<b>Left end installation</b>	Left Approx. 20°	Center	Right Approx. 30°	Right Approx. 45°	Right Approx. 50°

**(c) Swing**

**1) Swing flap**

Flap moves in upward and downward directions continuously.

- ◆ In HEAT operation
- ◆ In COOL, DRY, FAN operation

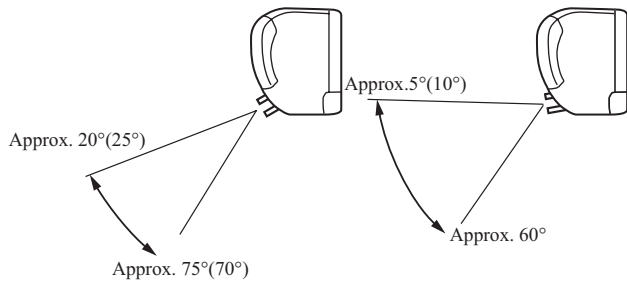

Note (1) value in ( ) are for the model SRK20~50ZJ-S.

**2) Swing louver**

Louver moves in left and right directions continuously.



**(d) Memory flap (Flap or Louver stopped)**

When you press the AIRFLOW (UP/DOWN or LEFT/RIGHT) button once while the flap or louver is operating, it stops swinging at the position. Since this angle is memorized in the microcomputer, the flap or louver will automatically be set at this angle when the next operation is started.

**(e) When not operating**

The flap returns to the position of air flow directly below, when operation has stopped.

◆ **SRF series**

Control the flap by AIRFLOW ◆ (UP/DOWN) button on the wireless remote controller.

**(a) Flap**

Each time when you press the AIRFLOW ◆ (UP/DOWN) button the mode changes as follows.

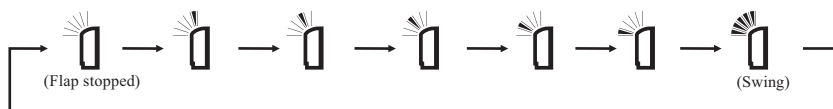

• Angle of Flap from Horizontal

Remote controller display					
<b>COOL , DRY, FAN</b>	Approx. 60°	Approx. 50°	Approx. 38°	Approx. 21.5°	Approx. 12°
<b>HEAT</b>	Approx. 44°	Approx. 32°	Approx. 21.5°	Approx. 12°	Approx. 5°

**(b) Swing**

**1) Swing flap**

Flap moves in upward and downward directions continuously.

- ◆ In HEAT operation
- ◆ In COOL, DRY, FAN operation



**(c) Memory flap (Flap stopped)**

When you press the AIRFLOW button once while the flap is operating, it stops swinging at the position. Since this angle is memorized in the microcomputer, the flap will automatically be set at this angle when the next operation is started.

**(d) When not operating**

The flap returns to the position of air flow directly below, when operation has stopped.

## (6) Air outlet selection (SRF series only)

(a) **AIR SELECTION button can switch between the combination of upper and lower air outlets and upper air outlet. Not operable while the air conditioner is OFF.**

- 1) Each time the AIR SELECTION button is pressed. The combination of the upper and lower air outlets and the upper air outlet can be switched.
- 2) When the upper air outlet is selected, AIR OUTLET SELECTION light on the unit display area will light green.

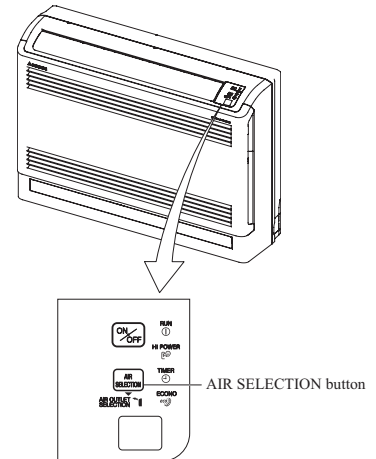

(b) **Auto air outlet selection**

### 1) COOL, DRY operation

- a) In case both lower and upper outlets operation is selected in Cooling or Dry operation, both outlets will be kept for sixty minutes after the start or until indoor temperature is below the setting point. And then the air outlet will change to the upper outlet. That state will be maintained until switch is turned off.
- b) In case both outlets operation with Auto fan speed mode is selected, the upper outlet will be kept for ten minutes after the start or until indoor temperature is close to reaching the setting point. And then the air outlet will change to both outlets in order to spread comfort air to every corner.

### 2) HEAT operation

- a) In case both lower and upper outlets operation with Auto fan speed mode is selected, the lower outlet will be kept for twenty minutes after the start or until indoor temperature is close to reaching the setting point. And then the air outlet will change to both outlets. That state will be maintained until the switch is turned off.
- b) Automatic adjustment of lower air outlet direction prevents stirring up of warm air and keeps optimum comfort at floor level.

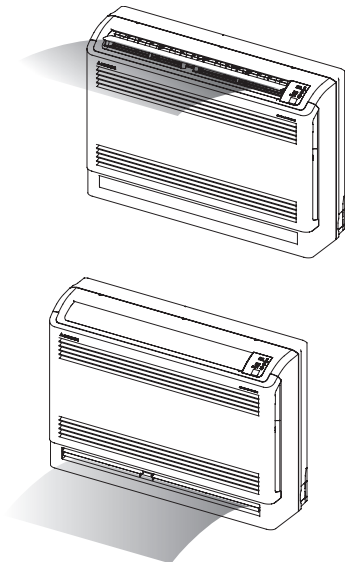

## (7) 3D auto operation (SRK series only)

Control the flap and louver by 3D AUTO button on the wireless remote controller.

Air flow selection and air flow direction are automatically controlled, allowing the entire indoor to efficiently conditioned.

(a) During Cooling and Heating (Including auto cooling and heating)

1) Air flow selection is determined according to indoor temperature and setting temperature.

Operation mode	Air flow selection				
	AUTO		HI	MED	LO
At cooling	Indoor temp. – Setting temp. >5°C	Indoor temp. – Setting temp. ≤ 5°C	HI	MED	LO
	HIGH POWER	AUTO			
At heating	Setting temp. – Indoor temp. >5°C	Setting temp. – Indoor temp. ≤ 5°C	HI	MED	LO
	HIGH POWER	AUTO			

2) Air flow direction is controlled according to the indoor temperature and setting temperature.

a) When 3D auto operation starts

	Cooling	Heating
Flap	Up/down Swing	
Louver	Wide (fixed)	Center (fixed)

b) When Indoor temp. – Setting temp. is  $\leq 5^{\circ}\text{C}$  during cooling and when Setting temp. – Indoor temp. is  $\leq 5^{\circ}\text{C}$  during heating, the system switches to the following air flow direction control. After the louver swings left and right symmetrically for 3 cycles, control is switched to the control in c).

	Cooling	Heating
Flap	Horizontal blowing (Fixed)	Slant forwardl blowing (Fixed)
Louver	Left/right Swing	

c) After the flap swings for 5 cycles, control is switched to the control in d).

	Cooling	Heating
Flap	Up/down Swing	
Louver	Center (Fixed)	

d) For 5 minutes, the following air flow direction control is carried out.

	Cooling	Heating
Flap	Horizontal blowing (Fixed)	Slant forwardl blowing (Fixed)
Louver	Wide (Fixed)	

e) After 5 minutes have passed, the air flow direction is determined according to the indoor temperature and setting temperature.

Operation mode	Air flow direction control		
At cooling	Indoor temp. – Setting temp. $\leq 2^{\circ}\text{C}$	$2^{\circ}\text{C} < \text{Indoor temp. – Setting temp.} \leq 5^{\circ}\text{C}$	Indoor temp. – Setting temp. $> 5^{\circ}\text{C}$
	The control in d) continues.	Control returns to the control in b).	Control returns to the control in a).
At heating	Setting temp. – Indoor temp. $\leq 2^{\circ}\text{C}$	$2^{\circ}\text{C} < \text{Setting temp. – Indoor temp.} \leq 5^{\circ}\text{C}$	Setting temp. – Indoor temp. $> 5^{\circ}\text{C}$
	The control in d) continues.	Control returns to the control in b).	Control returns to the control in a).

(b) During DRY Operation (including auto DRY operation)

Air flow selection	According to DRY operation.
Flap	Horizontal blowing (Fixed)
Louver	Wide (Fixed)

## (8) Timer operation

(a) Comfortable timer setting (ON timer)

If the timer is set at ON when the operation select switch is set at the cooling or heating, or the cooling or heating in auto mode operation is selected, the comfortable timer starts and determines the starting time of next operation based on the initial value of 15 minutes and the relationship between the indoor temperature at the setting time (temperature of room temperature sensor) and the setting temperature.

(b) Sleep timer operation

Pressing the SLEEP button causes the temperature to be controlled with respect to the set temperature.

(c) OFF timer operation

The Off timer can be set at a specific time (in 10-minute units) within a 24-hour period.

## (9) Installation location setting (SRK series only)

When the indoor unit is installed at the end of a room, control the air flow direction so that it is not toward the side walls. If you set the remote controller installation position, keep it so that the air flow is within the range shown in the following figure.

### (a) Setting

- 1) If the air conditioning unit is running, press the ON/OFF button to stop.

The installation location setting cannot be made while the unit is running.

- 2) Press the AIR FLOW  $\updownarrow$  (UP/DOWN) button and the AIRFLOW  $\leftarrow\rightarrow$  (LEFT/RIGHT) button together for 5 seconds or more.

The installation location display illuminates.

- 3) Setting the air-conditioning installation location.

Press the AIR FLOW  $\leftarrow\rightarrow$  (LEFT/RIGHT) button and adjust to the desired location.

Each time the AIR FLOW  $\leftarrow\rightarrow$  (LEFT/RIGHT) button is pressed, the indicator is switched in the order of:



- 4) Press the ON/OFF button.

The air-conditioner's installation location is set.

Press within 60 seconds of setting the installation location (while the installation location setting display illuminates).

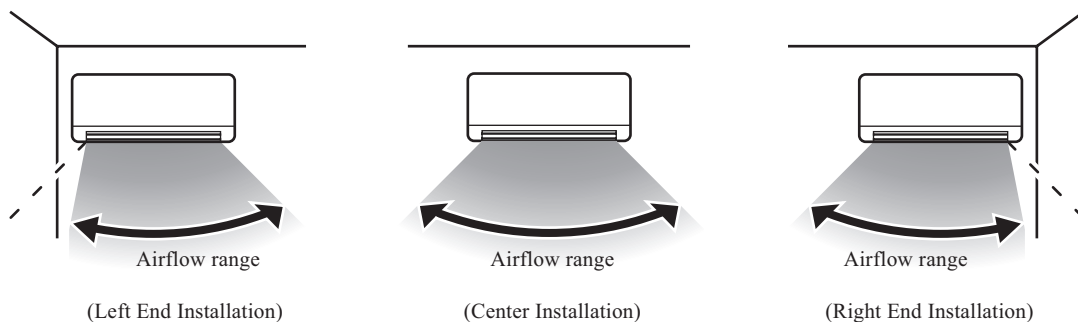
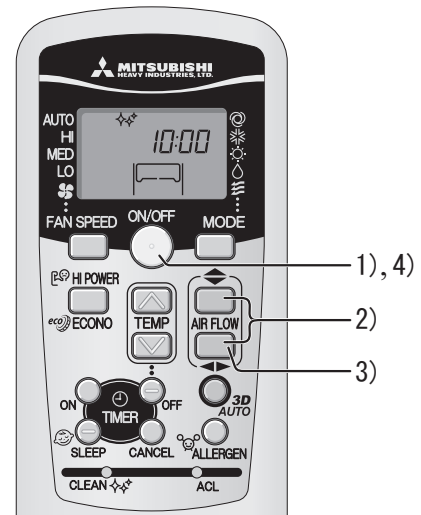

## (10) Determining the operating mode

The cooling and heating operating modes are the remote controller mode that have been previously determined.

If a mode differing from these is selected after this, the selected mode will appear in the display of the remote controller, but only the fan will operate.

Example	First operation			Second operation			Notes
	Selected Mode	Remote Controller Display	Operation	Selected Mode	Remote Controller Display	Operation	
1	Cooling	Cooling	Cooling	Heating	Heating	Fan <sup>(1)</sup>	• Different mode is only fan operation.
2	Heating	Heating	Heating	Cooling	Cooling	Fan	

Note (1) If the display shows heating and the operation is fan, Hot Keep will operate.

### Example of operating pattern

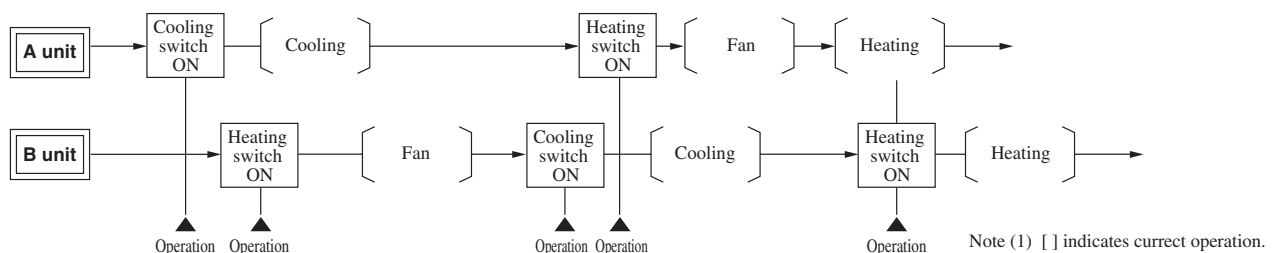

## (11) Drain motor (DM) control (SRR series only)

- (a) Drain motor (DM) is operated during the cooling or dehumidifying mode operations and simultaneously with the compressor ON. The DM continues to operate for 5 minutes after the operation stop, anomalous stop, thermostat stop or when it was switched from the cooling and dehumidifying operations to the fan or heating operation.

		Indoor unit operation mode				
		Stop <sup>(1)</sup>	Cooling	Dehumidifying	Fan <sup>(2)</sup>	Heating
Compressor ON		Control A				
Compressor OFF		Control B				

Note (1) Including the stop from the cooling, dehumidifying, fan and heating, and the anomalous stop  
 (2) Including the "Fan" operation according to the mismatch of operation modes

- 1) Control A
  - a) If the float switch detects any anomalous draining condition, the unit stops with the anomalous stop and the drain pump starts. After detecting the anomalous condition, the drain motor continues to be ON.
  - b) It keeps operating while the float switch is detecting the anomalous condition.
- 2) Control B
 

If the float switch detects any anomalous drain condition, the drain motor is turned ON for 5 minutes, and at 10 seconds after the drain motor OFF it checks the float switch. If it is normal, the unit is stopped under the normal mode or, if there is any anomalous condition, displayed by the flashing of display lights and the drain motor is turned ON. (The ON condition is maintained during the drain detection.)

## 1.2 FDTC series

### (1) Remote controller (Option parts)

#### (a) Wired remote controller

The figure below shows the remote controller with the cover opened. Note that all the items that may be displayed in the liquid crystal display area are shown in the figure for the sake of explanation  
 Characters displayed with dots in the liquid crystal display area are abbreviated.

The figure below shows the remote control with the cover opened.

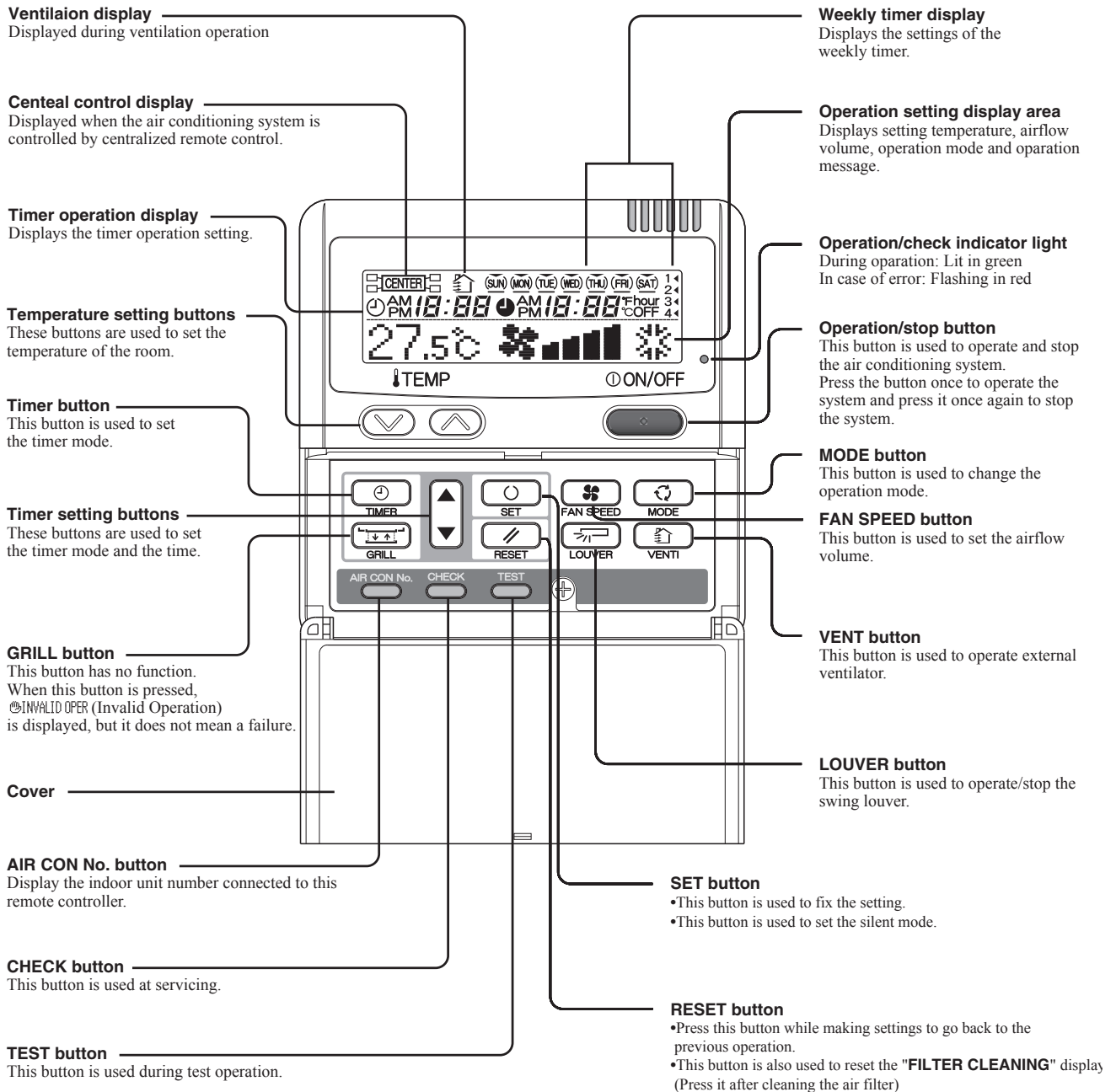

\* All displays are described in the liquid crystal display for explanation.

**(b) Wireless remote controller**

**Indication section**

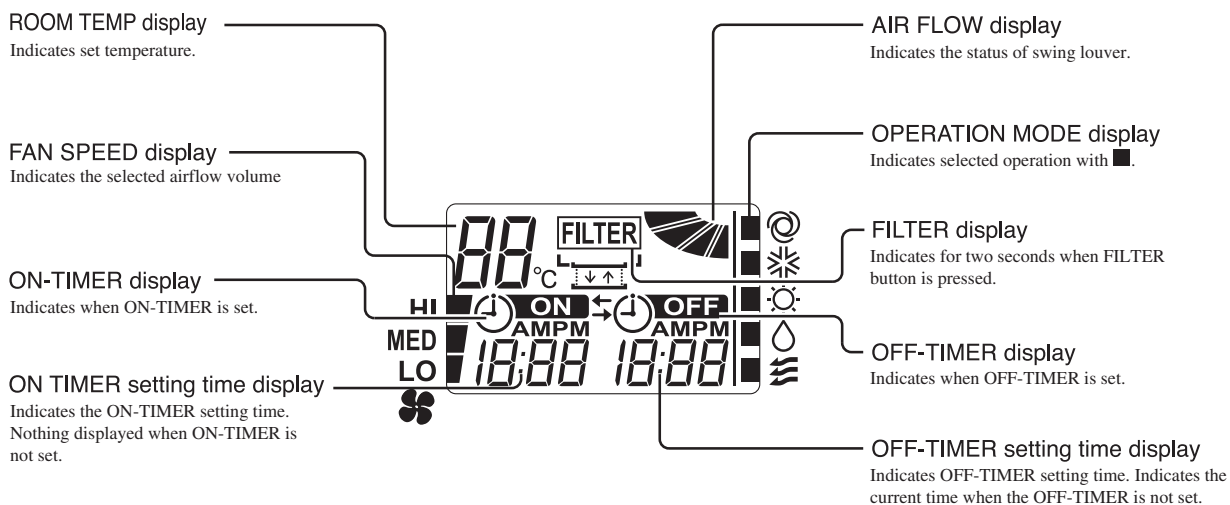

**Operation section**

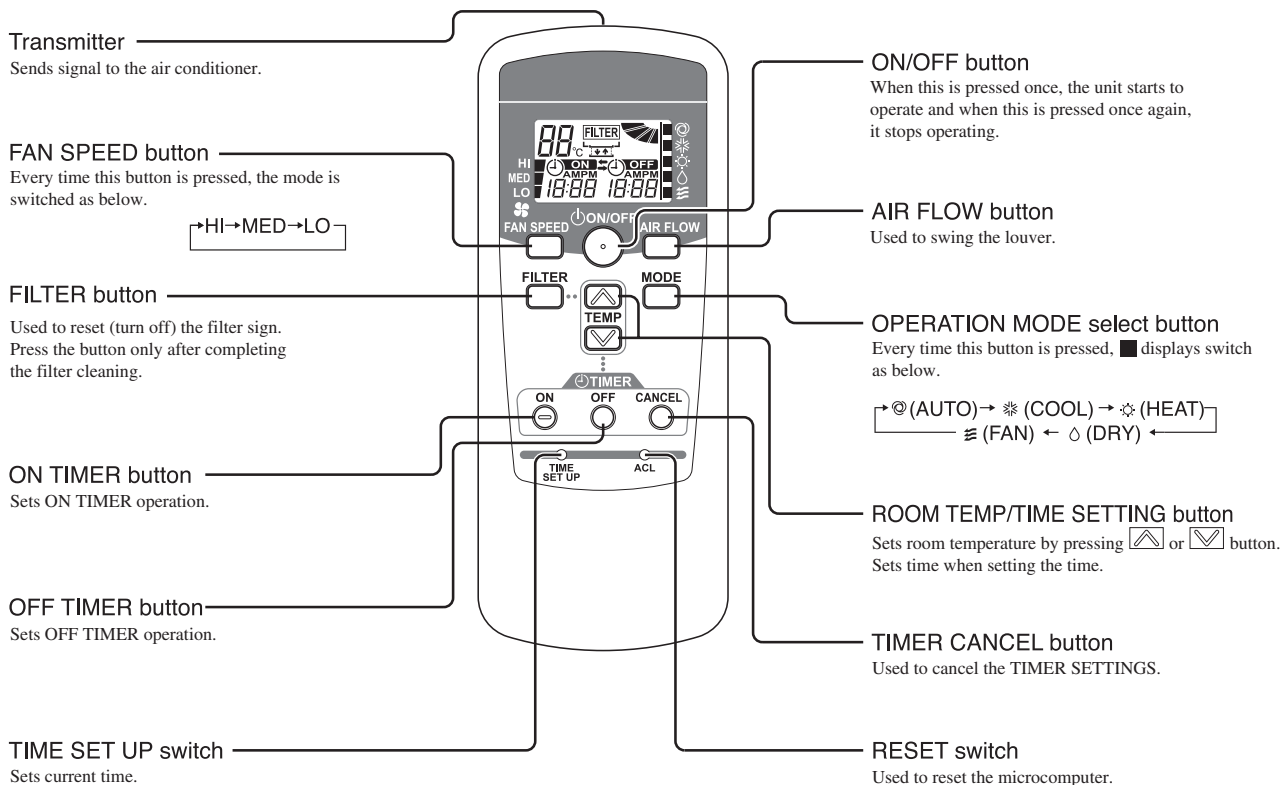

\* All displays are described in the liquid crystal display for explanation



## (2) Operation control function by the wired remote controller

### (a) Switching sequence of the operation mode switches of remote controller



### (b) [CPU reset]

This functions when “CHECK” and “GRILL” buttons on the remote controller are pressed simultaneously. Operation is same as that of the power supply reset.

### (c) [Power failure compensation function]...Electric power supply failure

- This becomes effective if “Power failure compensation effective” is selected with the setting of remote controller function.
- Since it memorizes always the condition of remote controller, it starts operation according to the contents of memory no sooner than normal state is recovered after the power failure. Although the auto swing stop position and the timer mode are cancelled, the weekly timer setting is restored with the holiday setting for all weekdays. After recovering from the power failure, it readjusts the clock and resets the holiday setting for each weekday so that the setting of weekly timer becomes effective.
- Content memorized with the power failure compensation are as follows.

Note (1) Items⑥, ⑦ and ⑧ are memorized regardless whether the power failure compensation is effective or not while the setting of silent mode is cancelled regardless whether the power failure compensation is effective or not.

- ① At power failure – Operating/stopped  
If it had been operating under the off timer mode, sleep timer mode, the state of stop is memorized. (Although the timer mode is cancelled at the recovery from power failure, the setting of weekly timer is changed to the holiday setting for all weekdays.)
- ② Operation mode
- ③ Airflow volume mode
- ④ Room temperature setting
- ⑤ Louver auto swing/stop  
However, the stop position (4-position) is cancelled so that it returns to Position (1).
- ⑥ “Remote controller function items” which have been set with the remote controller function setting (“Indoor function items” are saved in the memory of indoor unit.)
- ⑦ Upper limit value and lower limit value which have been set with the temperature setting control
- ⑧ Sleep timer and weekly timer settings (Other timer settings are not memorized.)

### [Parts layout on remote controller PCB]

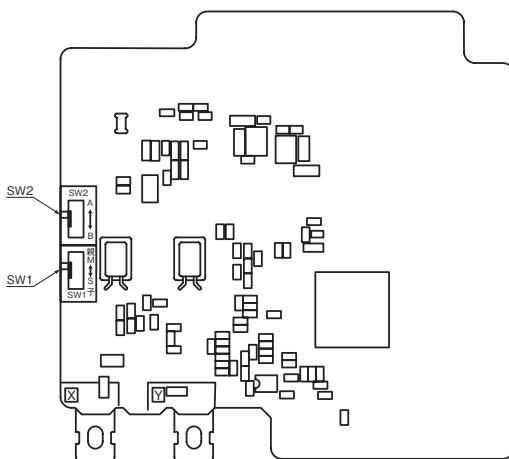

#### Master/ slave setting when more than one remote controllers are used

A maximum of two remote controllers can be connected to one indoor unit (or one group of indoor units.)

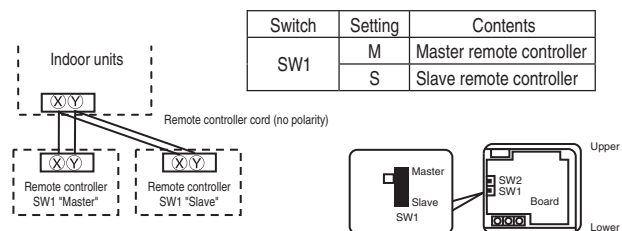

Set SW1 to “Slave” for the slave remote controller. It was factory set to “Master” for shipment.

Note: The setting “Remote controller thermistor enabled” is only selectable with the master remote controller in the position where you want to check room temperature.

The air conditioner operation follows the last operation of the remote controller regardless of the master / slave setting of it.

#### Caution

When using multiple remote controllers, the following displays or settings cannot be done with the slave remote controller. It is available only with the master remote controller.

- ① Louver position setting (set upper or lower limit of swinging range)
- ② Setting indoor unit functions
- ③ Setting temperature range
- ④ Operation data display
- ⑤ Error data display
- ⑥ Silent mode setting
- ⑦ Test operation of drain pump
- ⑧ Remote controller sensor setting

### (3) Operation control function by the indoor controller

#### (a) Auto operation

If “Auto” mode is selected by the remote controller, the heating and the cooling are automatically switched according to the difference between outdoor air temperature and setting temperature and the difference between setting temperature and return air temperature. (When the switching of cooling mode ↔ heating mode takes place within 3 minutes, the compressor does not operate for 3 minutes by the control of 3-minute timer.) This will facilitate the cooling/heating switching operation in intermediate seasons and the adaptation to unmanned operation at stores, etc.

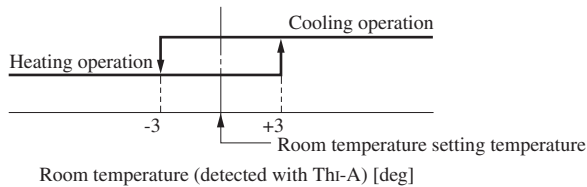

Note (1) Room temperature control during auto cooling/auto heating is performed according to the room temperature setting temperature. (DIFF: ±1 deg)  
 (2) If the indoor heat exchanger temperature rises to 59°C or higher during heating operation, it is switched automatically to cooling operation. In addition, for 1 hour after this switching, the heating operation is not performed, regardless of the temperature shown at right.

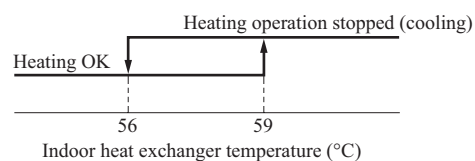

#### (b) Operations of functional items during cooling/heating

Operation Functional item	Cooling		Fan	Heating			Dehumidify
	Thermostat ON	Thermostat OFF		Thermostat ON	Thermostat OFF	Hot start (Defrost)	
Compressor	○	×	×	○	×	○	○/×
4-way valve	×	×	×	○	○	○(×)	×
Outdoor unit fan	○	×	×	○	×	○(×)	○/×
Indoor unit fan	○	○	○	○/×	○/×	○/×	○/×
Louver motor	○/×			○/×	○/×	○/×	○/×
Drain pump <sup>(3)</sup>	○	× <sup>(2)</sup>	× <sup>(2)</sup>	○/× <sup>(2)</sup>			Thermostat ON: ○ Thermostat OFF: × <sup>(2)</sup>

Note (1) ○: Operation ×: Stop ○/×: Turned ON/OFF by the control other than the room temperature control.  
 (2) ON during the drain motor delay control.  
 (3) Drain pump ON setting may be selected with the indoor unit function setting of the wired remote controller.

#### (c) Dehumidifying operation

- 1) When the humidity sensor is not provided
 

Return air temperature thermistor [Th1-A (by the remote controller when the remote controller thermistor is enabled)] controls the indoor temperature environment simultaneously.

  - a) Operation is started in the cooling mode. When the difference between the return air temperature and the setting temperature is 2°C or less, the indoor unit fan tap is brought down by one tap. That tap is retained for 3 minutes after changing the indoor unit fan tap.
  - b) If the return air temperature exceeds the setting temperature by 3°C during defrosting operation, the indoor unit fan tap is raised. That tap is retained for 3 minutes after changing the indoor unit fan tap.
  - c) If the thermostat OFF is established during the above control, the indoor unit fan tap at the thermostat ON is retained so far as the thermostat is turned OFF.
  - d) After stopping the cooling operation, the indoor unit continues to run at Lo for 15 seconds.
- 2) When the humidity thermistor is provided [Optional]
  - a) Operation starts in the cooling mode, and the target relative temperature is determined based on the setting temperature. If the humidity detected by the humidity thermistor becomes lower than the target relative temperature, the indoor unit fan tap is retained.
  - b) Anything other than a) above is same as the item 1) above.

**(d) Timer operation**

- 1) Sleep timer  
Set the duration of time from the present to the time to turn off the air-conditioner.  
It can be selected from 10 steps in the range from “OFF 1 hour later” to “OFF 10 hours later”. After the sleep timer setting, the remaining time is displayed with progress of time in the unit of hour.
- 2) OFF timer  
Time to turn OFF the air-conditioner can be set in the unit of 10 minutes.
- 3) ON timer  
Time to turn ON the air-conditioner can be set. Indoor temperature can be set simultaneously.
- 4) Weekly timer  
Timer operation (ON timer, OFF timer) can be set up to 4 times a day for each weekday.
- 5) Timer operations which can be set in combination

Item \ Item	Sleep timer	OFF timer	ON timer	Weekly timer
Sleep timer		×	○	×
OFF timer	×		○	×
ON timer	○	○		×
Weekly timer	×	×	×	

Note (1) ○: Allowed ×: Not

**(e) Remote controller display during the operation stop**

- 1) “Centralized control ON” is displayed always on the LCD under the “Center/Remote” and “Center” modes during the operation stop (Power ON). This is not displayed under the “Remote” mode.
- 2) If this display is not shown under the “Center/Remote” mode, check if the indoor unit power switch is turned on or not.

**(f) Hot start (Cold draft prevention at heating)**

At the startup of heating operation, at resetting of the thermostat, during defrost operation and at returning to heating, the indoor fan is controlled by the indoor heat exchanger temperature (detected with Th<sub>i</sub>-R) for preventing the cold draft.

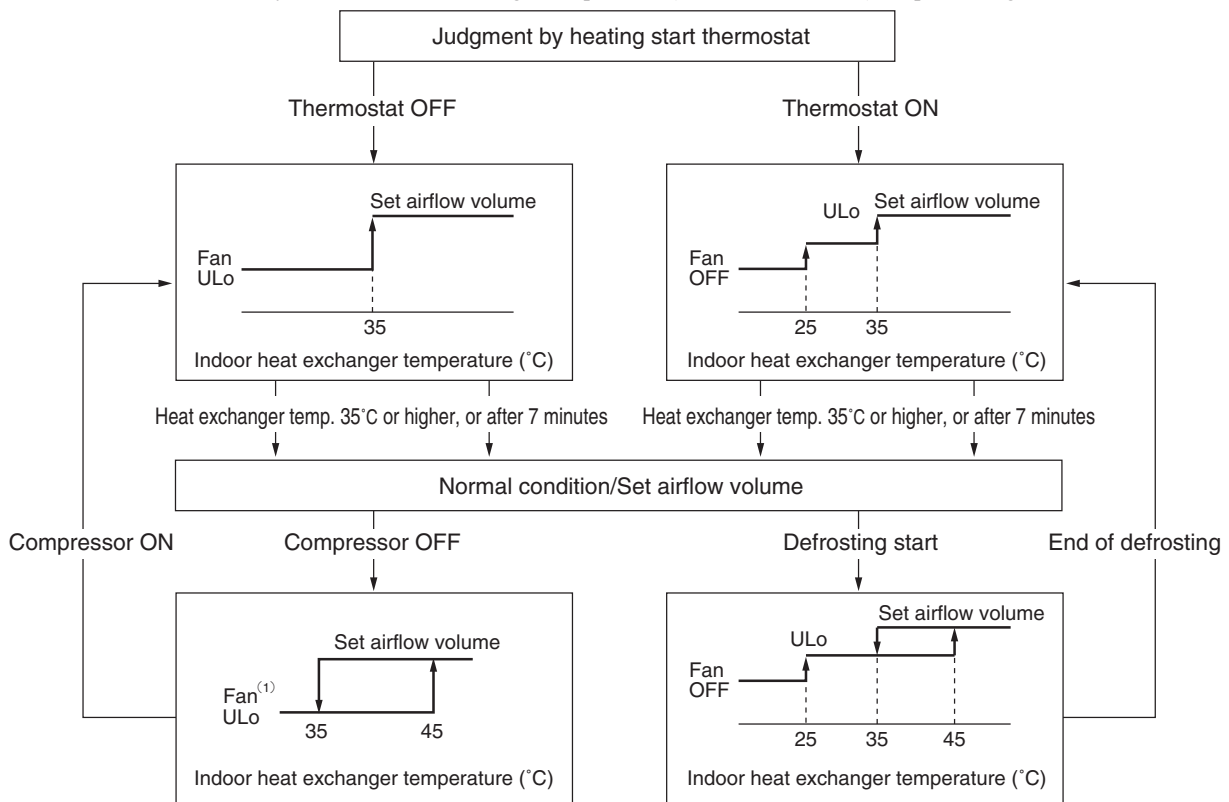

Note (1) Heating preparation is displayed during the hot start (when the compressor is operating and the indoor fan does not provide the set airflow volume).

**(g) Hot keep**

Hot keep control is performed at the start of the defrost control.

- 1) Control
  - a) When the indoor heat exchanger temperature (detected with Th-R1 or R2) drops to 35°C or lower, the speed of indoor fan is changed to the lower tap at each setting.
  - b) During the hot keep, the louver horizontal control signal is transmitted.
- 2) Ending condition
 

When the indoor fan is at the lower tap at each setting, it returns to the set airflow volume as the indoor heat exchanger temperature rises to 45°C or higher.

**(h) Fan control during the heating thermostat OFF**

When the heating thermostat is turned OFF, the setting of the fan control is selectable using the indoor function of wired remote controller [FAN CONTROL].

- 1) Low fan speed (Factory default)
 

If the indoor heat exchanger temperature drops below 35°C with the heating thermostat OFF, the indoor fan operate at the lower speed tap at each setting.
- 2) Set fan speed
 

Even if the indoor heat exchanger temperature drops below 35°C with the heating thermostat OFF, the indoor fan continues to run at the set airflow volume.
- 3) Intermittence
 

If the indoor heat exchanger temperature drops below 35°C with the heating thermostat OFF, the indoor fan operates at the lower speed tap at each setting and, when the indoor heater exchanger temperature drops below 25°C, the indoor fan stops for 5 minutes. Then the fan runs at the low speed tap for 2 minutes, and the judgment is made by the thermostat.
- 4) Fan OFF
 

If the indoor heat exchanger temperature drops below 35°C with the heating thermostat OFF, the indoor fan is turned OFF. The same applies also when the remote controller sensor is effective.

**(i) Filter sign**

As the operation time (Total ON time of ON/OFF switch) accumulates to 180 hours (1), “FILTER CLEANING” is displayed on the remote controller. (This is displayed when the unit is in trouble and under the centralized control, regardless of ON/OFF)

Note (1) Time setting for the filter sign can be made as shown below using the indoor function of wired remote controller “FILTER SIGN SET”. (It is set at 1 at the shipping from factory.)

Filter sign setting	Function
TYPE 1	Setting time: 180 hrs (Factory default)
TYPE 2	Setting time: 600 hrs
TYPE 3	Setting time: 1,000 hrs
TYPE 4	Setting time: 1,000 hrs (Unit stop) <sup>(2)</sup>

(2) After the setting time has elapsed, the “FILTER CLEANING” is displayed and, after operating for 24 hours further (counted also during the stop), the unit stops.

**(j) Auto swing control**

- 1) Louver control
  - a) Press the “LOUVER” button to operate the swing louver when the air conditioner is operating. “SWING 𐄂” is displayed for 3 seconds and then the swing louver moves up and down continuously.
  - b) To fix the swing louver at a position, press one time the “LOUVER” button while the swing louver is moving so that four stop positions are displayed one after another per second.
 

When a desired stop position is displayed, press the “LOUVER” button again. The display stops, changes to show the “STOP 1 𐄂” for 5 seconds and then the swing louver stops.
  - c) Louver operation at the power on with a unit having the louver 4-position control function
 

The louver swings one time automatically (without operating the remote controller) at the power on. This allows inputting the louver motor (LM) position, which is necessary for the microcomputer to recognize the louver position.

Note (1) If you press the “LOUVER” button, the swing motion is displayed on the louver position LCD for 10 second. The display changes to the “SWING 𐄂” display 3 seconds later.

2) Automatic louver level setting during heating

At the hot start with the heating thermostat OFF, regardless whether the auto swing switch is operated or not (auto swing or louver stop), the louver takes the level position (In order to prevent the cold start). The louver position display LCD continues to show the display which has been shown before entering this control.

3) Louver-free stop control

When the louver-free stop has been selected with the indoor function of wired remote controller “ POSITION”, the louver motor stops when it receives the stop signal from the remote controller. If the auto swing signal is received from the remote controller, the auto swing will start from the position where it was before the stop.

Note (1) When the indoor function of wired remote controller “ POSITION” has been switched, switch also the remote control function “ POSITION” in the same way.

4) Individual flap (louver) control system

Regarding FDTC model, the individual flaps (louvers) for 4 directions can be controlled to swing within the ranges between upper limit and lower limit selected with wired remote controller respectively.

For detail setting method, refer to ⑦ in page 160 for FDTC.

Note (1) This function is not able to be set with wireless remote controller or simple remote controller (RCH-E3)

**(k) Compressor inching prevention control**

1) 3-minute timer

When the compressor has been stopped by the thermostat, remote controller operation switch or anomalous condition, its restart will be inhibited for 3 minutes. However, the 3-minute timer is invalidated at the power on the electric power source for the unit.

2) 3-minute forced operation timer

- Compressor will not stop for 3 minutes after the compressor ON. However, it stops immediately when the unit is stopped by means of the ON/OFF switch or by when the thermister turned OFF the change of operation mode.
- If the thermostat is turned OFF during the forced operation control of heating compressor, the louver position (with the auto swing) is returned to the level position.

Note (1) The compressor stops when it has entered the protective control.

**(l) Drain motor**

1) Drain motor (DM) is operated during the cooling or dehumidifying mode operations and simultaneously with the compressor ON. The DM continues to operate for 5 minutes after the operation stop, anomalous stop, thermostat stop or when it was switched from the cooling and dehumidifying operations to the fan or heating operation.

	Indoor unit operation mode				
	Stop <sup>(1)</sup>	Cooling	Dehumidifying	Fan <sup>(2)</sup>	Heating
Compressor ON		Control A			
Compressor OFF		Control B			

Note (1) Including the stop from the cooling, dehumidifying, fan and heating, and the anomalous stop  
 (2) Including the “Fan” operation according to the mismatch of operation modes

a) Control A

- i) If the float switch detects any anomalous draining condition, the unit stops with the anomalous stop (displays E9) and the drain pump starts. After detecting the anomalous condition, the drain motor continues to be ON.
- ii) It keeps operating while the float switch is detecting the anomalous condition.

b) Control B

If the float switch detects any anomalous drain condition, the drain motor is turned ON for 5 minutes, and at 10 seconds after the drain motor OFF it checks the float switch. If it is normal, the unit is stopped under the normal mode or, if there is any anomalous condition, E9 is displayed and the drain motor is turned ON. (The ON condition is maintained during the drain detection.)

2) Drain motor (DM) interlock control

a) Start conditions

Depending on the function setting by the remote controller, the drain motor is turned ON under either one of the following conditions.

- i) During heating mode operation (Both the thermostat ON/OFF)
- ii) During heating mode operation (Both the thermostat ON/OFF) + Fan operation
- iii) Fan operation

b) End conditions

The drain motor is turned OFF 5 minutes after the stop of operations i) to iii) above.

**(m) Operation check/drain pump test run operation mode**

- 1) If the power is turned on by the dip switch (SW7-1) on the indoor PCB when electric power source is supplied, it enters the mode of operation check/drain pump test run. It is ineffective (prohibited) to change the switch after turning power on.
- 2) When the communication with the remote controller has been established within 60 seconds after turning power on by the dip switch (SW7-1) ON, it enters the operation check mode. Unless the remote controller communication is established, it enters the drain pump test run mode.

Note (1) To select the drain pump test run mode, disconnect the remote controller connector (CNB) on the indoor PCB to shut down the remote controller communication.

## 3) Operation check mode

There is no communication with the outdoor unit but it allows performing operation in respective modes by operating the remote controller.

## 4) Drain pump test run mode

As the drain pump test run is established, the drain pump only operates and during the operation protective functions by the microcomputer of indoor unit become ineffective.

**(n) Cooling, dehumidifying frost protection**

- 1) To prevent frosting during cooling mode or dehumidifying mode operation, the of compressor speed is reduced if the indoor heat exchanger temperature (detected with Th<sub>i</sub>-R) drops to 1.0 °C or lower at 4 minutes after the start of compressor operation. If the indoor unit heat exchanger temperature is 1.0 °C or lower after 20 seconds, the compressor speed is reduced further. If it becomes 2.5 °C or higher, the control terminates. When the indoor heat exchanger temperature has become as show below after reducing the compressor speed, it is switched to the fan operation. For the selection of indoor fan speed, refer to item 2).

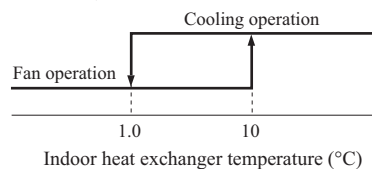

## 2) Selection of indoor fan speed

If it enters the frost prevention control during cooling operation (excluding dehumidifying), the indoor unit fan speed is switched.

- a) When the indoor return air detection temperature (detected with Th<sub>i</sub>-A) is 23°C or higher and the indoor heat exchanger temperature (detected with Th<sub>i</sub>-R) detects the compressor frequency drop start temperature A°C+1°C, of indoor unit fan speed is increased by 20rpm.
- b) If the phenomenon of i) above is detected again after the acceleration of indoor unit fan, indoor unit fan speed is increased further by 20rpm.

Note (1) Indoor unit fan speed can be increased by up to 2 taps.

## • Compressor frequency drop start temperature

Item	Symbol	A
Temperature - Low (Factory default)		1.0
Temperature - High		2.5

Note (1) Frost prevention temperature setting can be selected with the indoor unit function setting of the wired remote controller.

**(o) Heating overload protection**

- 1) If the indoor heat exchanger temperature (detected with Th<sub>i</sub>-R) at 63°C or higher is detected for 2 seconds continuously, the compressor stops. When the compressor is restarted after a 3-minute delay, if a temperature at 63°C or higher is detected for 2 seconds continuously within 60 minutes after initial detection and if this is detected 5 times consecutively, the compressor stops with the anomalous stop (E8). Anomalous stop occurs also when the indoor heat exchanger temperature at 63°C or higher is detected for 6 minutes continuously.

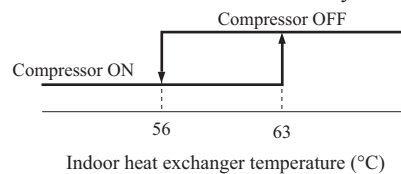

## 2) Indoor unit fan speed selection

If, after second detection of heating overload protection up to fourth, the indoor fan is set at Me and Lo taps when the compressor is turned ON, the indoor fan speed is increased by 1 tap.

**(p) Anomalous fan motor**

After starting the fan motor, if the fan motor speed is 200rpm or less is detected for 30 seconds continuously and 4 times within 60 minutes, then fan motor stops with the anomalous stop (E16).

**(q) Plural unit control – Control of 16 units group by one remote controller**

1) Function

One remote controller switch can control a group of multiple number of unit (Max. 16 indoor units). “Operation mode” which is set by the remote controller switch can operate or stop all units in the group one after another in the order of unit No.<sup>(1)</sup>. Thermostat and protective function of each unit function independently.

Note (1) Unit No. is set by SW2 on the indoor unit control PCB. Unit No. setting by SW2 is necessary for the indoor unit only.

SW2: For setting of 0 – 9, A – F

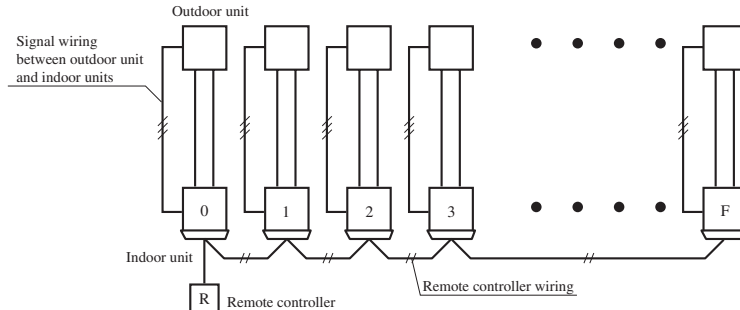

(2) Unit No. may be set at random unless duplicated, it should be better to set orderly like 0, 1, 2..., F to avoid mistake.

2) Display to the remote controller

- a) Center or each remote controller basis, heating preparation: the youngest unit No. among the operating units in the remote mode (or the center mode unless the remote mode is available) is displayed.
- b) Inspection display, filter sign: Any of unit that starts initially is displayed.
- c) Confirmation of connected units  
Pressing “AIR CON No.” button on the remote controller displays the indoor unit address. If “▲” “▼” button is pressed at the next, it is displayed orderly starting from the unit of youngest No.
- d) In case of anomaly
  - i) If any anomaly occurs on a unit in a group (a protective function operates), that unit stops with the anomalous stop but any other normal units continue to run as they are.
  - ii) Signal wiring procedure  
Signal wiring between indoor and outdoor units should be made on each unit same as the normal wiring. For the group control, lay connect with sires wiring between rooms using terminal blocks (X, Y) of remote controller.  
Connect the remote controller communication wire separately from the power supply wire or wires of other electric devices (AC220V or higher).

**(r) High ceiling control**

In the case of indoor unit installed in a higher ceiling room, the airflow volume mode control can be changed with the wired remote controller indoor unit function “FAN SPEED SET”.

Fan tap		Indoor unit airflow setting			
		PHi - Hi - Me - Lo	Hi - Me - Lo	Hi - Lo	Hi - Me
FAN SPEED SET	STANDARD	PHi - Hi - Me - Lo	Hi - Me - Lo	Hi - Lo	Hi - Me
	HIGH SPEED1, 2	PHi - PHi - Hi - Me	PHi - Hi - Me	PHi - Me	PHi - Hi

Note (1) Factory default is Standard.

(2) At the hot-start and heating thermostat OFF, or other, the indoor unit fan is operated at the low speed tap of each setting.

(3) This function is not able to be set with wireless remote controller or simple remote controller (RCH-E3)

**(s) Abnormal temperature thermistor (return air/indoor heat exchanger) wire/short-circuit detection**

1) Broken wire detection

When the return air temperature thermistor detects -50°C or lower or the heat exchanger temperature thermistor detect -50°C or lower for 5 seconds continuously, the compressor stops. After a 3-minute delay, the compressor restarts but, if it is detected again within 60 minutes after the initial detection for 6 minutes continuously, stops again (the return air temperature thermistor: E7, the heat exchanger temperature thermistor: E6).

2) Short-circuit detection

If the heat exchanger temperature thermistor detects 70°C or higher for 5 seconds continuously at 2 minutes and 20 seconds after the compressor ON during cooling operation, the compressor stops (E6).



**(t) Operation permission/prohibition**

**(In case of adopting card key switches or commercially available timers)**

When the indoor function setting of wired remote controller for “Operation permission/prohibition” is changed from “Invalid (Factory default)” to “Valid”, following control becomes effective.

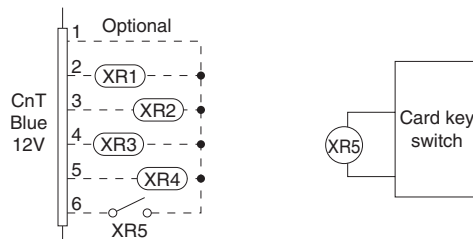

CnT-6	Normal operation (Factory default)		Operation permission/prohibition mode “Valid” (Local setting)	
	ON	OFF	ON	OFF
	Operation	Stop	Operation permission*1	Operation prohibition (Unit stops)

\*1 **Only the “LEVEL INPUT” is acceptable for external input**, however when the indoor function setting of “Level input (Factory default)” or “Pulse input” is selected by the function for “External input” of the wired remote controller, operation status will be changed as follows.

In case of “Level input” setting	In case of “Pulse input” setting
Unit operation from the wired remote controller becomes available*(1)	Unit starts operation *(2)

- \* (1) In case that “Operation permission/prohibition mode” setting is “Valid” and “External input” setting is “Level input (Factory default)”;
  - ① When card key switch is ON (CnT-6 ON: Operation permission), start/stop operation of the unit from the wired remote controller becomes available.
  - ② When card key switch is OFF (CnT-6 OFF: Operation prohibition), the unit stops operation in conjunction with OFF signal, and start/stop operation of the unit from the wired remote controller becomes not available.
- \* (2) In case that “Operation permission/prohibition mode” setting is “Valid” and “External input” setting is “Pulse input (Local setting)”;
  - ① When card key switch is ON (Operation permission), the unit starts operation in conjunction with ON signal. and also start/stop operation of the unit from the wired remote controller becomes available.
  - ② When card key switch is OFF (Operation prohibition), the unit stops operation in conjunction with OFF signal, and start/stop operation of the unit from the wired remote controller becomes not available.
- (3) This function is invalid only at “Center mode” setting done by central controller.

**(u) External input/output control (CnT)**

Be sure to connect the wired remote controller to the indoor unit. Without wired remote controller remote operation by CnT is not possible to perform.

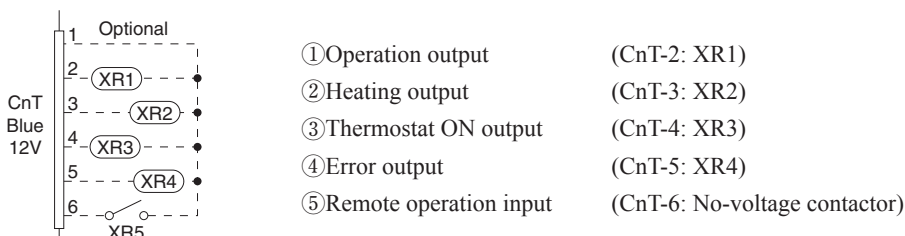

**1) Output for external control (remote display)**

Following output connectors (CnT) are provided on the indoor control PCB for monitoring operation status.

- ① **Operation output:** Outputs DC12V signal for driving relay during operation
- ② **Heating output:** Outputs DC12V signal for driving relay during heating operation
- ③ **Thermostat ON output:** Outputs DC12V signal for driving relay when compressor is operating.
- ④ **Error output:** Outputs DC12V signal for driving relay when anomalous condition occurs.



2) Remote operation input

Remote operation input connector (CnT-6) is provided on the indoor control PCB.

However remote operation by CnT-6 is not effective, when “Center mode” is selected by center controller.

In case of plural unit (twin, triple, double twin), remote operation input to CnT-6 on the slave indoor unit is invalid.

**Only the “LEVEL INPUT” is acceptable for external input**, however when the indoor function setting of “Level input (Factory default)” or “Pulse input” is selected by the function for “External input” of the wired remote controller, operation status will be changed as follows.

a) In case of “Level input” setting (Factory default)

Input signal to CnT-6 is OFF→ON ..... unit ON

Input signal to CnT-6 is ON→OFF ..... unit OFF

Operation is not inverted.

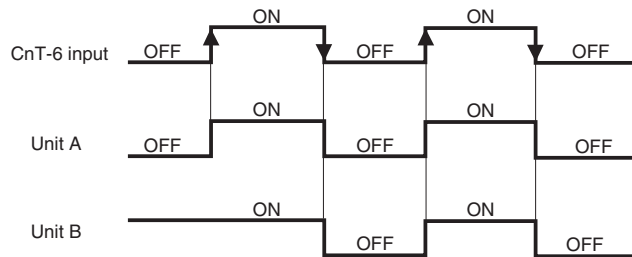

Note: The latest operation has priority

It is available to operate/stop by remote controller or center controller

b) In case of “Pulse input” setting (Local setting)

It is effective only when the input signal to CnT-6 is changed OFF→ON, and at that time unit operation [ON/OFF] is inverted.

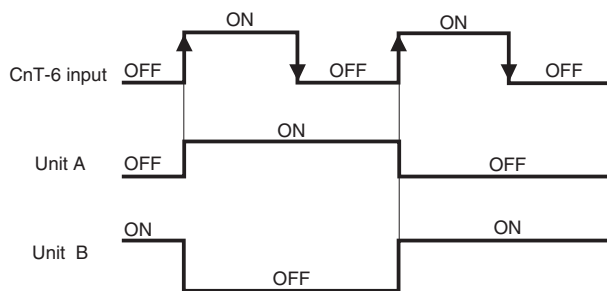

3) Remote operation

a) In case of multiple units (Max. 16 indoor units group) are connected to one wired remote controller

When the indoor function setting of wired remote controller for “External control set” is changed from “Individual (Factory default)” to “For all units”, all units connected in one wired remote controller system can be controlled by external operation input.

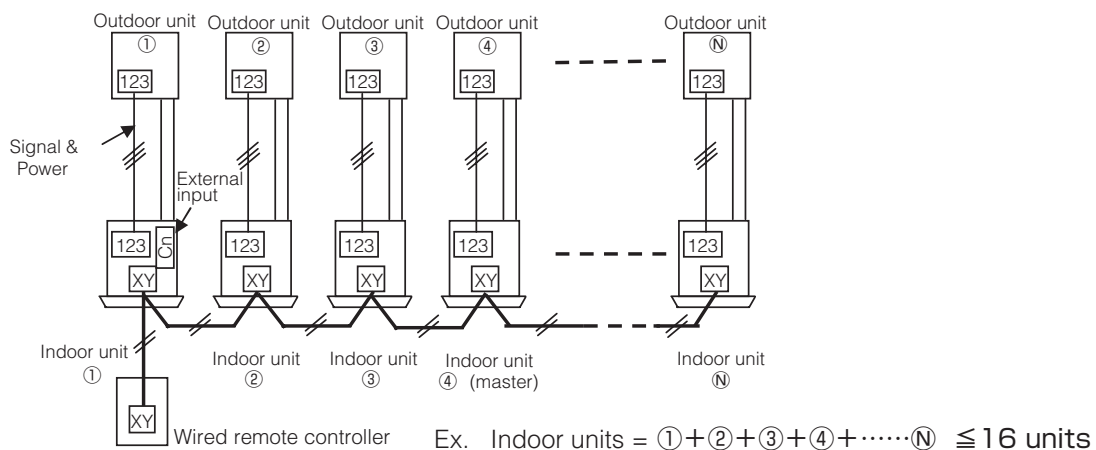

	Individual operation (Factory default)		All units operation (Local setting)	
	ON	OFF	ON	OFF
CnT-6	Only the unit directly connected to the remote controller can be operated.	Only the unit directly connected to the remote controller can be stopped operation.	All units in one remote controller system can be operated.	All units in one remote controller system can be stopped operation.
	Unit ① only	Unit ① only	Units ① – ⑩	Units ① – ⑩

When more than one indoor unit (Max. 16 indoor units) are connected in one wired remote controller system:

- (1) With the factory default, external input to CnT-6 is effective for only the unit ①.
- (2) When setting “For all unit” (Local setting), all units in one remote controller system can be controlled by external input to CnT-6 on the indoor unit ①.
- (3) External input to CnT-6 on the other indoor unit than the unit ① is not effective.

#### (v) Fan control at heating startup

##### 1) Start conditions

At the start of heating operation, if the difference of setting temperature and return air temperature is 5°C or higher after the end of hot start control, this control is performed.

##### 2) Contents of control

- a) Sampling is made at each minute and, when the indoor unit heat exchanger temperature (detected with Th1-R) is 37°C or higher, present number of revolutions of indoor unit fan speed is increased by 10min<sup>-1</sup>.
- b) If the indoor unit heat exchanger temperature drops below 37°C at next sampling, present number of revolutions of indoor unit fan speed is reduced by 10min<sup>-1</sup>.

##### 3) End conditions

Indoor fan speed is reduced to the setting airflow volume when the compressor OFF is established and at 30 minutes after the start of heating operation.

#### (w) Room temperature detection temperature compensation during heating

With the standard specification, the compressor is turned ON/OFF with the thermostat setting temperature. When the thermostat is likely to turn OFF earlier because the unit is installed at the ceiling where warm air tends to accumulate, the setting can be changed with the wired remote controller indoor unit function “※ SP OFFSET”. The compressor and the heater are turned ON/OFF at one of the setting temperature +3, +2 or +1°C in order to improve the feeling of heating. The setting temperature, however, has the upper limit of 30°C.

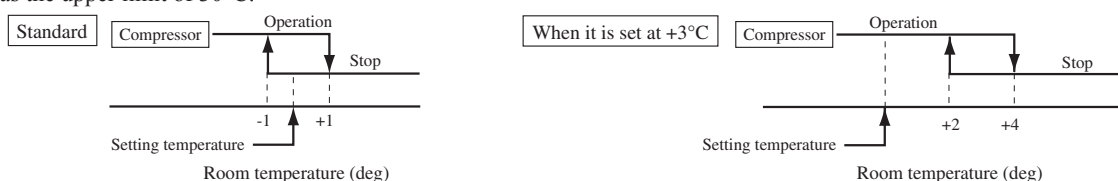

#### (x) Return air temperature compensation

This is the function to compensate the deviation between the detection temperature by the return air temperature thermistor and the measured temperature after installing the unit.

- 1) It is adjustable in the unit of 0.5°C with the wired remote controller indoor unit function “RETURN AIR TEMP”.
  - +1.0°C, +1.5°C, +2.0°C
  - -1.0°C, -1.5°C, -2.0°C
- 2) Compensated temperature is transmitted to the remote controller and the compressor to control them.

Note (1) The detection temperature compensation is effective on the indoor unit thermistor only.

## 1.3 Outline of heating operation

### (1) Summary

#### (a) Capacity control

##### 1) Indoor unit SRK 20~60 ZJX-S models only

Model	SCM40ZJ-S	SCM45ZJ-S	SCM50ZJ-S	SCM60ZJ-S	SCM71ZJ-S	SCM80ZJ-S
Capacity	1.4 ~ 6.9 kW	1.4 ~ 7.4 kW	1.4 ~ 7.5 kW	1.5 ~ 7.8 kW	1.5 ~ 9.4 kW	1.5 ~ 9.8 kW

##### 2) Indoor unit except SRK 20~60 ZJX-S models

Model	SCM40ZJ-S	SCM45ZJ-S	SCM50ZJ-S	SCM60ZJ-S	SCM71ZJ-S	SCM80ZJ-S
Capacity	1.4 ~ 6.7 kW	1.4 ~ 7.2 kW	1.4 ~ 7.3 kW	1.5 ~ 7.6 kW	1.5 ~ 9.1 kW	1.5 ~ 9.5 kW

Capacity control is within the range shown above. If demand capacity of the indoor units exceeds the maximum capacity of the outdoor unit, the demand capacity will be proportionally distributed.

#### (b) Outdoor compressor speed control

Indoor compressor command total speed value	Decision speed
0 rps	0 rps
A rps or less	A rps
More than A rps, but B rps or less	A rps to B rps
More than B rps	B rps

##### ● Values of A, B

Item	Model	SCM40ZJ-S	SCM45ZJ-S	SCM50ZJ-S
A		30 rps	30 rps	30 rps
B		100 rps	120 rps	120 rps

Item	Model	SCM60ZJ-S	SCM71ZJ-S	SCM80ZJ-S
A	Two connection	40 rps		
	More than three connection	30 rps		
B	One connection	90 rps		
	More than two connection	120 rps		

### (2) Operation of major functional components in heating mode

Functional components	Operation	Heating	Thermostat OFF (All indoor units)	Thermostat OFF (Some of indoor units)	Fan, stop, abnormal stop (Some of indoor units)	Failure (Outdoor unit)
Command speed		Multi-operation rpm calculated based on the rpm required for each indoor unit	0 (All indoor units)	0 (Thermostat off units)	0 (Fan, stop, abnormal stop units)	0 (All units)
Indoor unit fan	Fixed	According to mode switching	Hot Keep	According to mode switching		Hot Keep
	Automatic	According to command speed	Hot Keep	According to command speed		Hot Keep
Outdoor unit fan		According to outdoor unit speed	OFF	According to outdoor unit speed		OFF
Electronic expansion valve		According to decision speed	According to stop mode	According to heating stop unit control (Thermostat off units)	According to heating stop unit control (Fan, stop, abnormal stop units)	According to stop mode
Compressor		ON	OFF	ON	ON	OFF

### (3) Hot keep operation

If the hot keep operation is selected during the heating operation, the indoor fan is controlled based on the temperature of the indoor unit heat exchanger (Th2) to prevent blowing of cool wind.

Note (1) Refer to the FDTC series by 21 page.

**(4) Defrosting operation**

**(a)** Starting conditions (Defrosting operation can be started only when all of the following conditions are met.)

- 1) After start of heating operation  
When it elapsed 40 minutes. (Accumulated compressor operation time)
- 2) After end of defrosting operation  
When it elapsed 40 minutes. (Accumulated compressor operation time)
- 3) Outdoor heat exchanger temperature (Th1)  
When the temperature has been below -2°C for 3 minutes continuously.
- 4) The condition of outdoor air temperature (Th2) and the outdoor heat exchanger temperature (Th1)

$$(Th2) - (Th1) \geq 0.44 \times (Th2) + A$$

Th2	A
-2 °C ≤ Th2	4
-15 °C ≤ Th2 < -2 °C	6
Th2 < -15 °C	6

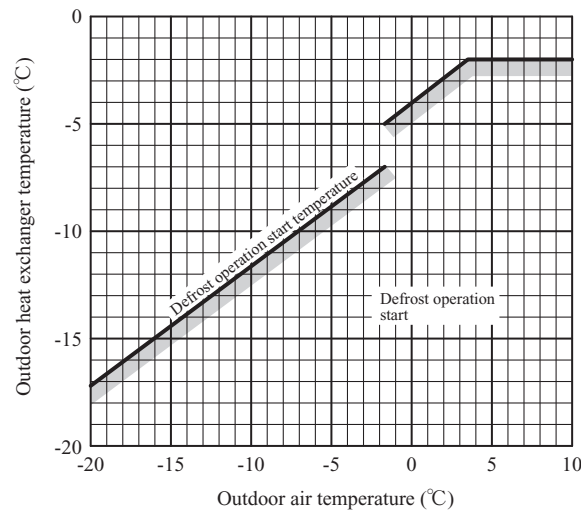

5) During continuous compressor operation

In addition, when the speed command from the indoor controller of the indoor unit during heating operation has counted 0 rps 10 times or more and all conditions of 1), 2), 3) and 5) above and the outdoor air temperature is 3°C or less are satisfied (note that when the temperature for outdoor heat exchanger sensor (Th1) is -2°C or less: 62 rps or more, -2°C or less: less than 62 rps), defrost operation is started.

**(b)** Ending conditions (Operation returns to the heating cycle when either one of the following is met.)

- 1) Outdoor heat exchanger sensor (Th1) temperature: 20°C or higher
- 2) Outdoor heat exchanger sensor (Th1) temperature : 2 min. as for 10°C (model 71, 80 : 1 min. as for 18°C )
- 3) Continued operation time of defrosting → For more than 12 minutes and 50 seconds

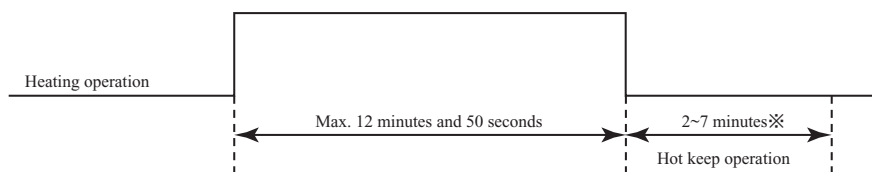

※ Depends on an operation condition, the time can be longer than 7 minutes.

## 1.4 Outline of cooling operation

### (1) Summary

#### (a) Capacity control

##### 1) Indoor unit SRK xx ZJX-S models only

Model	SCM40ZJ-S	SCM45ZJ-S	SCM50ZJ-S	SCM60ZJ-S	SCM71ZJ-S	SCM80ZJ-S
Capacity	1.8 ~ 5.9 kW	1.8 ~ 6.4 kW	1.8 ~ 7.1 kW	1.8 ~ 7.5 kW	1.8 ~ 8.8 kW	1.8 ~ 9.2 kW

##### 2) Indoor unit except SRK xx ZJX-S models

Model	SCM40ZJ-S	SCM45ZJ-S	SCM50ZJ-S	SCM60ZJ-S	SCM71ZJ-S	SCM80ZJ-S
Capacity	1.8 ~ 5.8 kW	1.8 ~ 6.3 kW	1.8 ~ 6.9 kW	1.8 ~ 7.3 kW	1.8 ~ 8.3 kW	1.8 ~ 8.7 kW

Capacity control is within the range shown above. If demand capacity of the indoor units exceeds the maximum capacity of the outdoor unit, the demand capacity will be proportionally distributed.

#### (b) Outdoor compressor speed control

Indoor compressor command total speed value	Decision speed
0 rps	0 rps
A rps or less	A rps
More than A rps, but B rps or less	A rps to B rps
More than B rps	B rps

##### ● Values of A, B

Model	SCM40ZJ-S	SCM45ZJ-S	SCM50ZJ-S	SCM60ZJ-S	SCM71ZJ-S	SCM80ZJ-S
A	30 rps	30 rps	30 rps	20 rps	20 rps	20 rps
B	100 rps	120 rps	120 rps	120 rps	120 rps	120 rps

### (2) Operation of major functional components in cooling mode

Functional components	Operation	Cooling	Thermostat OFF (All indoor units)	Thermostat OFF (Some of indoor units)	Fan, stop, abnormal stop (Some of indoor units)	Failure (Outdoor unit)
Command speed		Multi-operation rpm calculated based on the rpm required for each indoor unit	0 (All indoor units)	0 (Thermostat off units)	0 (Fan, stop, abnormal stop units)	0 (All units)
Indoor unit fan	Fixed	According to mode switching				
	Automatic	According to command speed	According to mode switching	According to command speed		
Outdoor unit fan		According to outdoor unit speed	OFF	According to outdoor unit speed		OFF
Electronic expansion valve		According to decision speed	According to stop mode	All closed (Thermostat off units)	All closed (Fan, stop, abnormal stop units)	According to stop mode
Compressor		ON	OFF	ON	ON	OFF

## 1.5 Outline of automatic operation

### (1) SRK 20~60ZJX-S, SRF and SRR series

#### (a) Determination of operation mode

The unit checks the indoor air temperature and the outdoor air temperature after operating the indoor and outdoor blowers for 20 seconds, determines the operation mode and the indoor air temperature setting correction value, and then enters in the automatic operation.

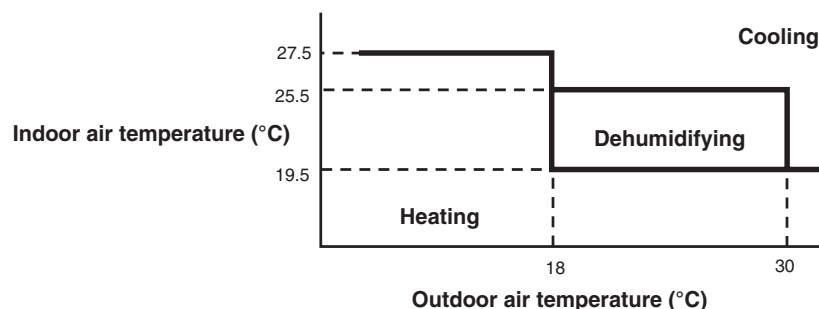

- (b) The unit checks the temperature every hour after the start of operation and, if the result of check is not same as the previous operation mode, changes the operation mode.
- (c) When the unit is started again within one hour after the stop of automatic operation or when the automatic operation is selected during heating, cooling or dehumidifying operation, the unit is operated in the previous operation mode.
- (d) Setting temperature can be adjusted within the following range. There is the relationship as shown below between the signals of the wireless remote controller and the setting temperature.

◆ **SRF series**

Unit : °C

		Signals of wireless remote control (Display)												
		-6	-5	-4	-3	-2	-1	±0	+1	+2	+3	+4	+5	+6
Setting temperature	Cooling	18	19	20	21	22	23	24	25	26	27	28	29	30
	Dehumidifying	18	19	20	21	22	23	24	25	26	27	28	29	30
	Heating	20	21	22	23	24	25	26	27	28	29	30	31	32

◆ **SRK, SRR series**

Unit : °C

		Signals of wireless remote control (Display)												
		-6	-5	-4	-3	-2	-1	±0	+1	+2	+3	+4	+5	+6
Setting temperature	Cooling	18	19	20	21	22	23	24	25	26	27	28	29	30
	Dehumidifying	19	20	21	22	23	24	25	26	27	28	28	30	31
	Heating	20	21	22	23	24	25	26	27	28	29	30	31	32

(2) **SRK 20~50ZJ-S series**

(a) **Determination of operation mode**

The unit checks the indoor air temperature and setting temperature and the outdoor air temperature, determines the operation mode, and then begins in the automatic operation.

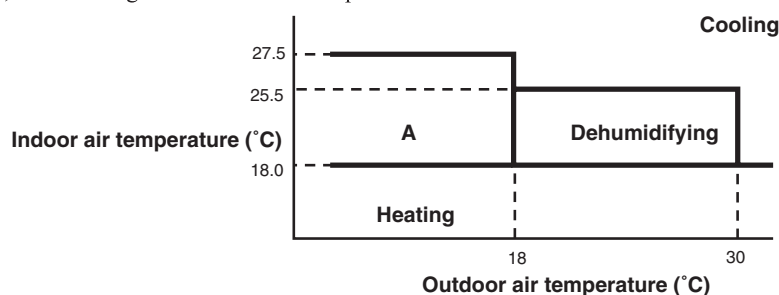

- (b) The unit checks the temperature every hour after the start of operation and, if the result of check is not same as the previous operation mode, changes the operation mode.
  - 1) If the setting temperature is changed with the remote controller, the operation mode is judged immediately.
  - 2) When both the indoor and the outdoor air temperatures are in the range “A”, cooling or heating is switched depending on the difference between the setting temperature and the indoor air temperature.
  - 3) When the operation mode has been judged following the change of setting temperature with the remote controller, the hourly judgment of operation mode is cancelled.
- (c) When the unit is started again within one hour after the stop of automatic operation or when the automatic operation is selected during heating, cooling or dehumidifying operation, the unit is operated in the previous operation mode.
- (d) Setting temperature can be adjusted within the following range. There is the relationship as shown below between the signals of the wireless remote controller and the setting temperature.

Unit : °C

		Signals of wireless remote controller (Display)												
		-6	-5	-4	-3	-2	-1	±0	+1	+2	+3	+4	+5	+6
Setting temperature	Cooling	18	19	20	21	22	23	24	25	26	27	28	29	30
	Dehumidifying	19	20	21	22	23	24	25	26	27	28	29	30	31
	Heating	20	21	22	23	24	25	26	27	28	29	30	31	32

(3) **FDTC series**

Refer to page 19.

## 1.6 Operation permission/prohibition control

(Refer to the FDTC series by 25 page)

The air conditioner operation is controlled by releasing the jumper wire (J3) on the indoor PCB and inputting the external signal into the CnT.

Note (1) Please install the separately-sold Interface kit (SC-BIK-E). Remove the jumper wire (J1 or J3) from the Interface kit circuit board.

- (1) **The operation mode is switched over between Permission and Prohibition by releasing the jumper wire (J3) on the indoor PCB.**

When the jumper wire (J3) is short circuited	When the jumper wire (J3) is released
Normal operation is enable (when shipping) When CnT input is set to ON, the operation starts and if the input is set to OFF, the operation stops. For the CnT and remote control inputs, the input which is activated later has priority and can start and stop the operation.	Permission / Prohibition mode When Cnt input is set to ON, the operation mode is changed to permission and if input is set to OFF the operation is prohibited.

- (2) **In the case of CnT input ON (Operation permission)**

- (a) The air conditioner can be operated or stopped by the remote control signal.  
 (When the "CENTER" mode is set, the operation can be controlled only by the center input.)
- (b) When the CnT input is changed from OFF to ON, the air conditioner operation mode is changed depending on the status of the jumper wire (J1) on the indoor control board.

When the jumper wire (J1) is short circuited	When the jumper wire (J1) is released
The signal (1) above starts the air conditioner. (Shipping status)	When the CnT input is set to ON, the air conditioner starts operation. After that, the operation of the air conditioner depends on (a) above. (Local status)

- (3) **In the case of CnT input OFF (Operation prohibition)**

- (a) Air-conditioner is unable to control the operation/stop, ect. in accordance with signals from the remote controller signal wire.
- (b) Air-conditioner stops as it changes CnT input ON → OFF.

## 1.7 External control (remote display)/control of input signal

(Refer to the FDTC series by 25 page)

- (1) **External control (remote display) output**

Following output connectors (CNT) are provided on the printed circuit board of indoor unit.

Note (1) Please install the separately-sold Interface kit (SC-BIK-E). The output connector (CNT) is located on the circuit board of the Interface kit.

- **Operation output:** Power to engage DC 12V relay (provided by the customer) is outputted during operation.
- **Heating output:** Power to engage DC 12V relay (provided by the customer) is outputted during the heating operation.
- **Compressor OPERATION output:** Power to engage DC 12V relay (provided by the customer) is outputted while the compressor is operating.
- **MALFUNCTION output:** When any error occurs, the power to engage DC 12V relay (provided by the customer) is outputted.

- (2) **Control of input signal**

Control of input signal (switch input, timer input) connectors (CNT) are provided on the printed circuit board of indoor unit.

However, when the operation of air conditioner is under the Center Mode, the remote control by CnT is invalid.

**(a) Level input**

If the factory settings (Jumper wire J1 EXTERNAL INPUT on the PCB of indoor unit) are set, or “LEVEL INPUT” is selected in the wired remote control’s indoor unit settings.

- 1) Input signal to CnT OFF → ON - - - - - Air conditioner ON
- 2) Input signal to CnT ON → OFF - - - - - Air conditioner OFF

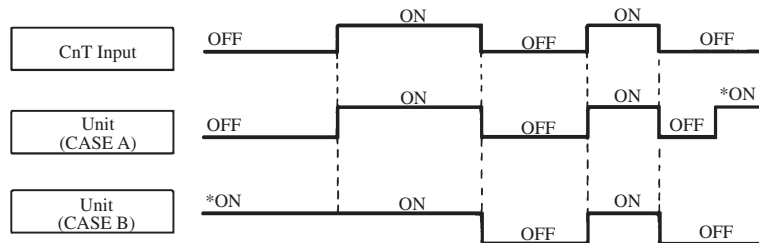

Note (1) The ON with the \* mark indicates an ON operation using the remote control unit switch, etc.

**(b) Pulse input**

When Jumper wire J1 on the PCB of indoor unit is cut at the field or “PULSE INPUT” is selected in the wired remote control’s indoor unit settings.

Input signal to CnT becomes valid at OFF → ON only and the motion of air conditioner [ON/OFF] is inverted.

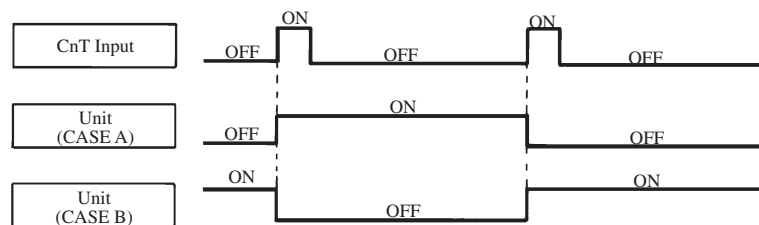

**1.8 Protective control function**

**(1) Frost prevention control** (During cooling or dehumidifying)

**(a) Operating conditions**

- 1) Indoor heat exchanger temperature (Th2) is lower than 2.5°C.
- 2) 8 minutes after reaching the compressor command speed except 0 rps.

**(b) Detail of anti-frost operation**

Operation mode	Protective control	Reset
Item		
Compressor operation	Forced outage	Operation instruction
Indoor fan	Depends on operation mode	Depends on operation mode

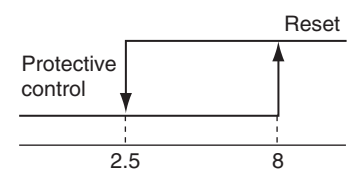

**(c) Reset conditions:** The indoor heat exchanger temperature (Th2) is 8°C or higher.

**(2) Cooling overload protective control**

**(a) Operating conditions:** When the outdoor air temperature (TH2) has become continuously for 30 seconds at 41°C or more, or 47°C or more with the compressor running, the lower limit speed of compressor is brought up.

Model	SCM 40~80 ZJ-S	
Item		
Outdoor air temperature	41°C or more	47°C or more
Lower limit speed	30 rps	40 rps

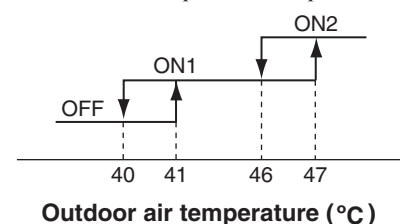



**(b) Detail of operation**

The lower limit of compressor command speed is set to 30 or 40 rps and even if the calculated result becomes lower than that after fuzzy calculation, the speed is kept to 30 or 40 rps. However, when the thermo becomes OFF, the speed is reduced to 0 rps.

**(c) Reset conditions:** When either of the following condition is satisfied.

- 1) The outdoor air temperature is lower than 40°C.
- 2) The compressor command speed is 0 rps.

**(3) Cooling high pressure control**

**(a) Purpose:** Prevents anomalous high pressure operation during cooling.

**(b) Detector:** Outdoor heat exchanger sensor (Th1)

**(c) Detail of operation:**

**(Example) Fuzzy**

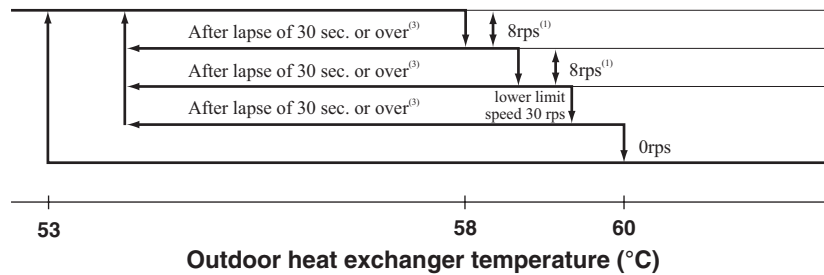

- Notes
- (1) When the outdoor heat exchanger temperature is in the range of 58~60°C, the compressor command speed is reduced by 8 rps at each 20 seconds.
  - (2) When the temperature is 60°C or higher, the compressor is stopped.
  - (3) When the outdoor heat exchanger temperature is in the range of 53~58°C, if the compressor command speed is been maintained and the operation has continued for more than 30 seconds at the same speed, it returns to the normal cooling operation.

**(4) Cooling low outdoor temperature protective control**

**(a) Operating conditions:** When the outdoor air temperature (Th2) is 22°C or lower continues for 20 seconds while compressor command speed is other than 0 rps.

**(b) Detail of operation:**

- ① The lower limit of compressor command speed is set to B or D rps and even if the speed becomes lower than B or D rps, the speed is kept to B or D rps. However, when the thermo becomes OFF, the speed is reduced to 0 rps.
- ② The upper limit of compressor command speed is set to A or C rps, the speed is kept to A or C rps.

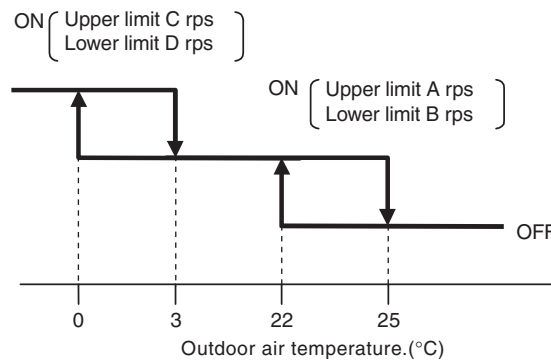

● Values of A ~ D

Model	SCM40ZJ-S	SCM45ZJ-S	SCM50ZJ-S	SCM60ZJ-S	SCM71ZJ-S	SCM80ZJ-S
<b>A</b>	75 rps	75 rps	75 rps	75 rps	75 rps	75 rps
<b>B</b>	35 rps	35 rps	35 rps	30 rps	30 rps	30 rps
<b>C</b>	60 rps	60 rps	60 rps	60 rps	60 rps	60 rps
<b>D</b>	45 rps	45 rps	45 rps	40 rps	40 rps	40 rps

**(c) Reset conditions:** When the either of the following condition is satisfied

- ① When the outdoor air temperature (Th2) becomes 25°C or higher.
- ② When the compressor command speed is 0rps.

**(5) Heating high pressure control****(a) Indoor unit side**

- 1) **Start condition:** When the indoor heat exchanger temperature (Th2) has become higher than the start temperature for 1 minute continuously.
- 2) **Contents of control:** Compressor stop

Indoor air temp.(Th1)	Item	Release temperature	Start temperature
$Th1 \leq 24^{\circ}\text{C}$		48.5°C	62°C
$24^{\circ}\text{C} < Th1 \leq 27^{\circ}\text{C}$		47.5°C	61°C
$27^{\circ}\text{C} < Th1$		46.5°C	60°C

- 3) **Release condition:** When the indoor heat exchanger temperature (Th2) has become lower than the release temperature.

**(b) Outdoor unit side**

- 1) **Start condition:** When the indoor heat exchanger temperature (Th2) has risen to a specified temperature while the compressor is turned on.
- 2) **Compressor command speed is controlled according to the zones of indoor heat exchanger temperature as shown by the following table.**

	$Th2 < P1$	$P1 \leq Th2 < P2$	$P2 \leq Th2 < P3$	$P3 \leq Th2$
Protection control speed (NP)	Normal	Retention	NP-4rps	NP-8rps
Sampling time (s)	Normal	20	20	20

**• Model SCM40~50**

Unit: °C

NP	Th2	P1	P2	P3
$10 \leq NP < 115$		45	52	57.5
$115 \leq NP < 120$		45 ~ 43	52 ~ 50	57.5 ~ 55
$120 \leq NP$		43	50	55

**• Model SCM60~80**

Unit: °C

NP	Th2	P1	P2	P3
$10 \leq NP < 90$		45	52	57
$90 \leq NP < 100$		45 ~ 44.5	52 ~ 49.5	57 ~ 54
$100 \leq NP < 110$		44.5 ~ 44	49.5 ~ 47.5	54 ~ 51
$110 \leq NP < 120$		44 ~ 43	47.5 ~ 45	51 ~ 48
$120 \leq NP$		43	45	48

**(6) Heating overload protective control****(a) Indoor unit side**

- 1) **Operating conditions :** When the outdoor air temperature (Th2) is 17°C or higher continues for 30 seconds while the compressor command speed other than 0 rps.
- 2) **Detail of operation :** The indoor fan is stepped up by 1 speed step. [Upper limit 8th (SRF, SRR:9th, FDTC:4th) speed]
- 3) **Reset conditions :** The outdoor air temperature (Th2) is lower than 16°C.

**(b) Outdoor unit side**

- 1) **Operating conditions :** When the outdoor air temperature (Th2) is 10°C or 17°C (model 60 ~ 80:13°C or 17°C) or higher continues for 30 seconds while the compressor command speed other than 0 rps.
- 2) **Detail of operation**
  - a) Taking the upper limit of compressor command speed range at A or C, if the output speed obtained with the fuzzy calculation exceeds the upper limit, the upper limit value is maintained.
  - b) The lower limit of compressor command speed is set to B or D and even if the calculated result becomes lower than that after fuzzy calculation, the speed is kept to B or D. However, when the thermo becomes OFF, the speed is reduced to 0 rps.
  - c) Inching prevention control is activated and inching prevention control is carried out with the minimum speed set at B or D.

**3) Reset conditions:** The outdoor air temperature (Th2) is lower than 8°C (model 60 ~ 80:11°C).

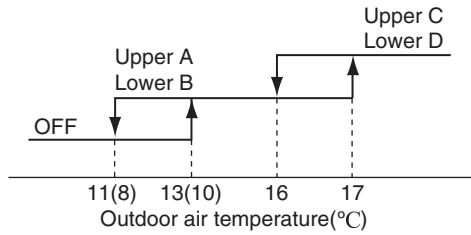

Note(1) Value in ( ) are for the model SCM40, 45.

		Unit: rps			
Model	Item	A	B	C	D
SCM40, 45		90	35	75	40
SCM50		90	35	75	40
SCM60, 71, 80		90	30	75	40

### (7) Heating low outdoor temperature protective control

**(a) Operating conditions:** When the outdoor air temperature (Th2) is lower than 4°C or higher continues for 30 seconds while the compressor command speed is other than 0 rps.

**(b) Detail of operation:** The lower limit compressor command speed is change as shown in the figure below.

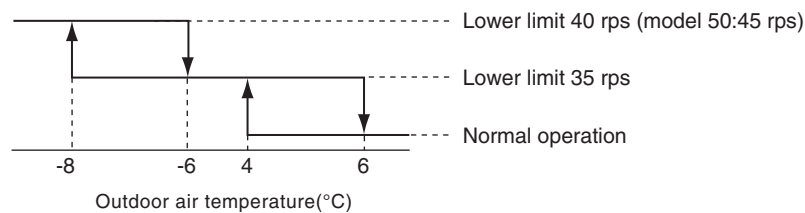

**(c) Reset conditions:** When either of the following condition is satisfied.

- 1) The outdoor air temperature (TH2) becomes 6°C.
- 2) The compressor command speed is 0 rps.

### (8) Freezing cycle system protective control

**(a) Starting condition:** This control starts when the following conditions are met.

- 1) When it has elapsed 30 minutes after the compressor was changed from OFF to ON in the cooling operation mode for more than 5 minutes.
- 2) When the compressor command speed has met the following conditions.
- 3) When the indoor air temperature of running indoor unit (Th1) and the indoor heat exchanger temperature (Th2) have met the following condition even on one unit.

Unit	Compressor command speed	Indoor air temperature (Th1, °C)	Indoor air temperature (Th1) and indoor heat exchanger temperature (Th2)	Duration
1	40 (60) rps	$10 \leq Th1 \leq 40$	$Th1 - 4 < Th2$	5 minute
2	50 (70) rps		$Th1 - 3 < Th2$	
3	60 (80) rps		$Th1 - 2 < Th2$	
4	70 rps			

Note (1) Value in ( ) are for the model 40 – 50.

**(b) Contents of control**

- 1) Stop the compressor and delay the start, and then restarts.
- 2) Compressor stops by the abnormal stop when the compressor stop has occurred 3 times in one hour.

### (9) Crankcase heater

**(a) Operating conditions** (When all the conditions below are satisfied)

- ① After the operation mode is changed to stop and the compressor command speed becomes 0 rps continuously for 30 minutes.
- ② When the temperature detected by the outdoor air temperature (Th2) is 10°C or lower after the compressor stops.

**(b) Detail of operation**

The crankcase heater operates, warming up the compressor, then refrigerant begins circulating smoothly when the cooler starts its heating operation, and heating begins.

**(c) Restoration conditions**

When the temperature detected by the outdoor air temperature (Th2) reaches 12°C or higher, or the operation mode changes from stop to cooling or heating.

**(10) Inching prevention**

When the compressor becomes to the thermo operation within 5 minutes since operation start or becomes dehumidifying operation, the operation is continued with the compressor command speed of minimum rps forcibly.

**(11) Compressor overheat protection**

**(a) Purpose:** It is designed to prevent deterioration of oil, burnout of motor coil and other trouble resulting from the compressor overheat.

**(b) Detail of operation**

1) Speeds are controlled with temperature detected by the sensor (Th3) mounted on the discharge pipe.

(Example) Fuzzy

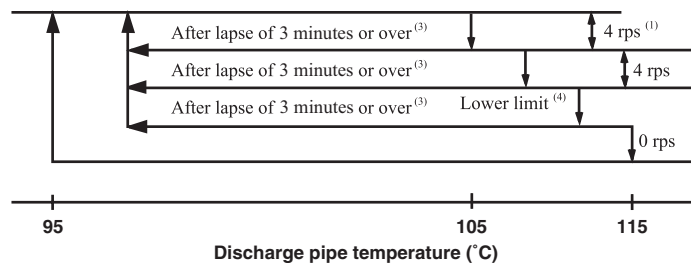

- Notes (1) When the discharge pipe temperature is in the range of 105~115°C, the speed is reduced by 4 rps.  
 (2) When the discharge pipe temperature is raised and continues operation for 20 seconds without changing, then the speed is reduced again by 4 rps.  
 (3) If the discharge pipe temperature is in the range of 95~105°C even when the compressor command speed is maintained for 3 minutes when the temperature is in the range of 95~105°C, the speed is raised by 1 rps and kept at that speed for 3 minutes. This process is repeated until the command speed is reached.  
 (4) Lower limit speed

Model	Item	Cooling	Heating	
		Lower limit speed	40 ~ 50	32 rps
		60 ~ 80	25 rps	32 rps

2) If the temperature of 115°C is detected by the sensor on the discharge pipe, then the compressor will stop immediately. When the discharge pipe temperature drops and the time delay of 3 minutes is over, the unit starts again within 1 hour but there is no start at the third time.

**(12) Current safe**

**(a) Purpose:** Current is controlled not to exceed the upper limit of the setting operation current.

**(b) Detail of operation:** Input current to the converter is monitored with the current sensor fixed on the printed circuit board of the outdoor unit and, if the operation current value reaches the limiting current value, the compressor command speed is reduced.  
 If the mechanism is actuated when the compressor command speed is less than 30 rps, the compressor is stopped immediately. Operation starts again after a delay time of 3 minutes.

**(c) Current safe control value: Set this using the jumper wire (J1 or J2) on the outdoor PCB. Control starts when it exceeds the control value.**

1) Switching with jumper wire

		Jumper wire (J2)	
		Short-circuit (At shipping from factory)	Short-circuit
Jumper wire (J1)	Short-circuit (At shipping from factory)	Current safe ①	Current safe ②
	Open	Current safe ③	Current safe ③

## 2) Control value

Unit: A

Model	Current safe ①		Current safe ②		Current safe ③	
	Cooling	Heating	Cooling	Heating	Cooling	Heating
SCM 40, 45, 50ZJ - S	10.0	12.0	10.0	10.0	7.5	7.5
SCM 60ZJ - S	11.0	14.0	10.0	10.0	7.5	7.5
SCM 71, 80ZJ - S	13.0	16.0	10.0	10.0	7.5	7.5

### (13) Current cut

(a) **Purpose:** Inverter is protected from overcurrent.

(b) **Detail of operation:** Output current from the inverter is monitored with a shunt resistor and, if the current exceeds the setting value, the compressor is stopped immediately. Operation starts again after a delay time of 3 minutes.

### (14) Outdoor unit failure

This is a function for determining when there is trouble with the outdoor unit during air conditioning.

The compressor is stopped if any one of the following item (a), (b) is satisfied. Once the unit is stopped by this function, it is not restarted.

(a) When the input current is measured at 1 A or less for 3 continuous minutes or more.

(b) If the compressor command sends a 0 rps signal to the indoor unit 3 times or more within 20 minutes of the power being turned on.

### (15) Indoor fan motor protection (Refer to the FDTC series by 23 page)

When the air conditioner is operating and the indoor fan motor is turned ON, if the indoor fan motor has operated at 300 (SRF:150) rpm or under for more than 30 seconds, the unit enters first in the stop mode and then stops the entire system.

### (16) Discharge pipe sensor disconnection protection control

(a) When the compressor command speed is other than 0 rps.

1)  $Th3(10) - Th3(0) < 8\text{ }^{\circ}\text{C}$ , and  $Th3(10) - Th2(10) < 5\text{ }^{\circ}\text{C}$

The compressor command speed is set on A rps for 5 minutes. After 5 minutes, the compressor command speed is set on B rps for 5 minutes.

2)  $Th3(20) - Th3(15) < 5\text{ }^{\circ}\text{C}$  :

The compressor command speed is set on 0 rps.

(b) Once the unit is stopped by this function, it is not restarted.

Notes (1) Th3(X): After compressor operation, the discharge pipe sensor temperature after X minutes.

(2) Th2(X): After compressor operation, the outdoor air sensor temperature after X minutes.

• Values of A, B

Model	SCM40ZJ-S	SCM45ZJ-S	SCM50ZJ-S	SCM60ZJ-S	SCM71ZJ-S	SCM80ZJ-S
A	30 rps	30 rps	30 rps	20 rps	20 rps	20 rps
B	60 rps	60 rps	60 rps	60 rps	60 rps	60 rps

### (17) Regulation of outdoor air flow

(a) The fan operates as follows according to the compressor command speed. (Except during defrost.)

#### ◆SCM40~60ZJ-S

Compressor speed (rps)	Cooling		Heating	
	Model 40: Less than 40	Model 40: 40 or more	Model 40: Less than 56	Model 40: 56 or more
Model 45: Less than 40	Model 45: 40 or more	Model 45: Less than 56	Model 45: 56 or more	
Model 50: Less than 48	Model 50: 48 or more	Model 50: Less than 61	Model 50: 61 or more	
Model 60: Less than 48	Model 60: 48 or more	Model 60: Less than 61	Model 60: 61 or more	
Outdoor fan speed	5th speed	6th speed	5th speed	6th speed

## ◆SCM71, 80 ZJ-S

Compressor speed (rps)	Cooling				Heating			
	Less than 31	More than 31 but 46 or less	More than 46 but 66 or less	66 or more	Less than 31	More than 31 but 66 or less	More than 66 but 85 or less	85 or more
Outdoor fan speed	3rd speed	4th speed	5th speed	6th speed	3rd speed	4th speed	5th speed	6th speed

(b) If the outdoor unit's fan speed drops, the outdoor fan is run for 1 minute at that speed.

**(18) Serial signal transmission error protection**

(a) **Purpose:** Prevents malfunction resulting from error on the indoor ↔ outdoor signals.

(b) **Detail of operation:** If the compressor is operating and a serial signal cannot be received from the indoor control with outdoor control having serial signals continues for 7 minute and 35 seconds, the compressor is stopped.

After the compressor has been stopped, it will be restarted after the compressor start delay if a serial signal can be received again from the indoor control.

**(19) Rotor lock**

If the motor for the compressor does not turn after it has been started, it is determined that a compressor lock has occurred and the compressor is stopped.

**(20) Outdoor fan motor protection**

If the outdoor fan motor has operated at 75 rpm or under for more than 30 seconds, the compressor and fan motor are stopped.

**(21) Outdoor fan control at low outdoor temperature**◆ **Cooling**

(a) **Operating conditions:** When the outdoor air temperature (Th2) is 22°C or lower continues for 30 seconds while the compressor command speed is other than 0 rps.

(b) **Detail of operation:** After the outdoor fan operates at A speed for 60 seconds; the corresponding outdoor heat exchanger temperature shall implement the following controls.

## ● Value of A

	Outdoor fan
Outdoor air temperature > 10°C	2nd speed
Outdoor air temperature ≤ 10°C	1st speed

1) Outdoor heat exchanger temperature (Th1) ≤ 22°C

After the outdoor fan speed drops (down) to 1 speed for 60 seconds; if the outdoor heat exchanger temperature is lower than 22°C, gradually reduce the outdoor fan speed by 1 speed.

## ● lower limit speed

	Lower limit speed
Outdoor air temperature > 16°C	2nd speed
Outdoor air temperature ≤ 16°C	1st speed

2) 22°C < Outdoor heat exchanger temperature (Th1) ≤ 40°C

After the outdoor fan speed maintains at A speed for 20 seconds; if the outdoor heat exchanger temperature is 22°C~40°C, maintain outdoor fan speed.

3) Outdoor heat exchanger temperature (Th1) > 40°C

After the outdoor fan speed rises (up) to 1 speed for 60 seconds; if the outdoor heat exchanger temperature is higher than 40°C, gradually increase outdoor fan speed by 1 speed. (Upper limit 4th (model 71,80:3rd) speed)

(c) **Reset conditions:** When either of the following conditions is satisfied

1) The outdoor air temperature (Th2) is 24°C or higher.

2) The compressor command speed is 0 rps.

◆ Heating

- (a) **Operating conditions:** When the outdoor air temperature (Th2) is 3°C or lower continues for 30 seconds while the compressor command speed is other than 0 rps.
- (b) **Detail of operation:** The outdoor fan is stepped up by 1 speed. (Upper limit 7th speed)
- (c) **Reset conditions:** When either of the following conditions is satisfied
  - 1) The outdoor air temperature (Th2) is 5°C or higher.
  - 2) The compressor command speed is 0 rps.

(22) Outdoor unit fan control at overload

◆ Cooling

- (a) **Start condition:** When the outdoor air temperature (Th2) has risen higher than 41°C for 30 seconds continuously while the compressor is operating.

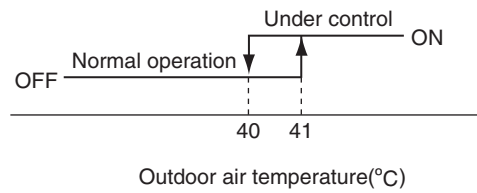

- (b) **Contents of control:** The outdoor unit fan tap is brought up by 3 steps (Higher limit is 6th tap.)
- (c) **Release condition:** When the compressor is turned off or the outdoor heat exchanger temperature (Th1) has dropped lower than 40°C.

◆ Heating

- (a) **Start condition:** When the outdoor air temperature (Th2) has risen higher than 13°C for 30 seconds continuously while the compressor is operating.

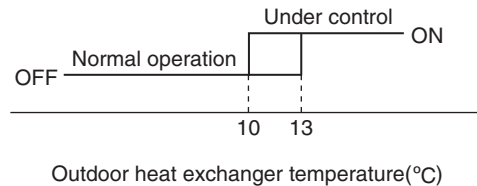

- (b) **Contents of control:** The outdoor unit fan tap is brought down by 3 steps (Lower limit is 2nd tap.)
- (c) **Release condition:** When the compressor is turned off or the outdoor heat exchanger temperature (Th1) has dropped lower than 10°C.

## 2 MAINTENANCE DATA

### 2.1 SRK, SRF and SRR series

#### (1) Cautions

- If you are disassembling and checking an air conditioner, be sure to turn off the power before beginning. When working on indoor units, let the unit sit for about 1 minute after turning off the power before you begin work. When working on an outdoor unit, there may be an electrical charge applied to the main circuit (electrolytic condenser), so begin work only after discharging this electrical charge (to DC 10 V or lower).
- When taking out printed circuit boards, be sure to do so without exerting force on the circuit boards or package components.
- When disconnecting and connecting connectors, take hold of the connector housing and do not pull on the lead wires.

#### (2) Items to check before troubleshooting

- Have you thoroughly investigated the details of the trouble which the customer is complaining about?
- Is the air conditioner running? Is it displaying any self-diagnosis information?
- Is a power supply with the correct voltage connected?
- Are the control lines connecting the indoor and outdoor units wired correctly and connected securely?
- Is the outdoor unit's service valve open?

#### (3) Troubleshooting procedure (If the air conditioner does not run at all)

If the air conditioner does not run at all, diagnose the trouble using the following troubleshooting procedure. If the air conditioner is running but breaks down, proceed to troubleshooting step (4).

**Important** When all the following conditions are met, we say that the air conditioner will not run at all.

- The RUN light does not light up.
- The flaps do not open.
- The indoor unit fan motors do not run.
- The self-diagnosis display does not function.

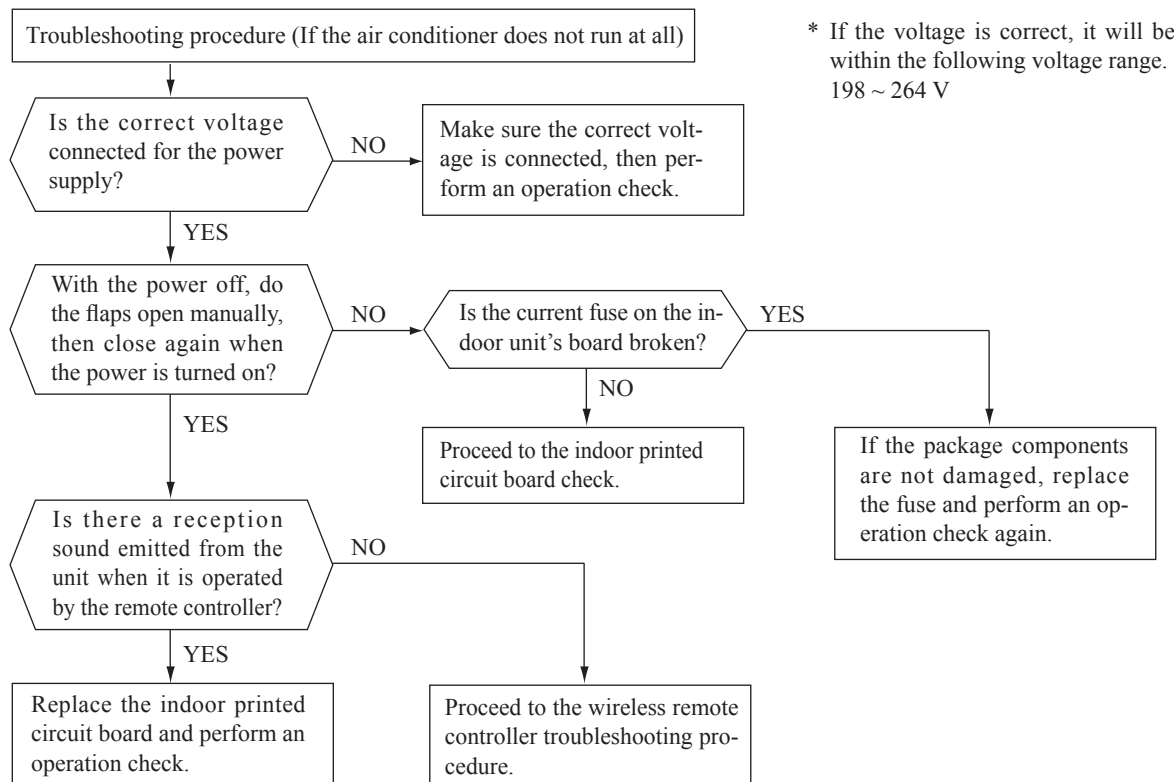



(4) Troubleshooting procedure (If the air conditioner runs)

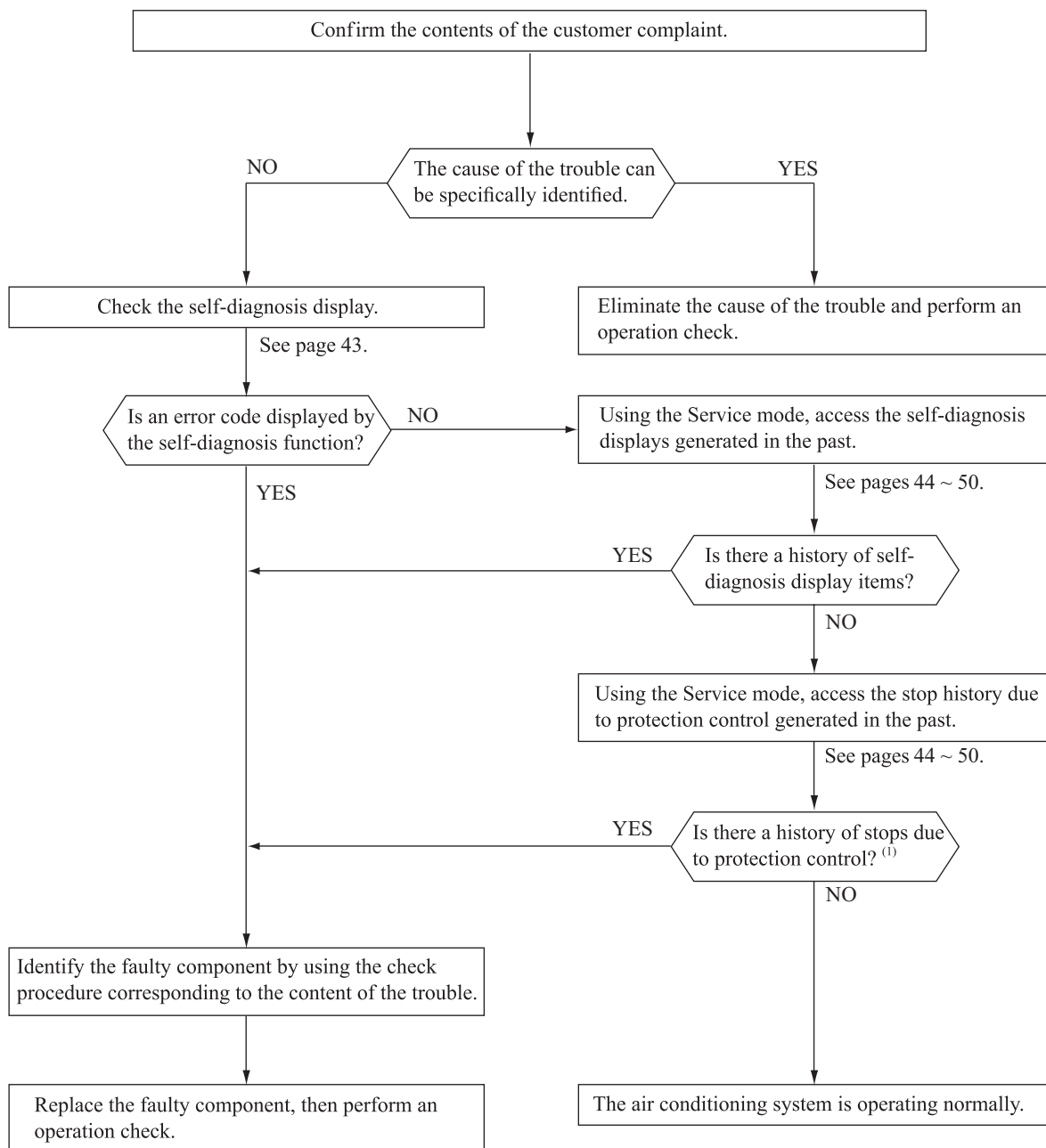

Note (1) Even in cases where only intermittent stop data are generated, the air conditioning system is normal. However, if the same protective operation recurs repeatedly (3 or more times), it will lead to customer complaints. Judge the conditions in comparison with the contents of the complaints.

**(5) Self-diagnosis table**

When this air conditioner performs an emergency stop, the reason why the emergency stop occurred is displayed by the flashing of display lights. If the air conditioner is operated using the remote controller 3 minutes or more after the emergency stop, the trouble display stops and the air conditioner resumes operation. <sup>(1)</sup>

Indoor unit display panel		Outdoor main PCB Red LED	Wired <sup>(2)</sup> remote controller display	Description of trouble	Cause	Display (flashing) condition
RUN light	TIMER light					
1 time flash	ON	Stays OFF	—	Heat exchanger sensor 1 error	• Broken heat exchanger sensor 1 wire, poor connector connection • Indoor PCB is faulty	When a heat exchanger sensor 1 wire disconnection is detected while operation is stopped. (If a temperature of -28°C or lower is detected for 15 seconds, it is judged that the wire is disconnected.) (Not displayed during operation.)
2 times flash	ON	Stays OFF	—	Room temperature sensor error	• Broken room temperature sensor wire, poor connector connection • Indoor PCB is faulty	When a room temperature sensor wire disconnection is detected while operation is stopped. (If a temperature of -45°C or lower is detected for 15 seconds, it is judged that the wire is disconnected.) (Not displayed during operation.)
3 times flash	ON	Stays OFF	—	Heat exchanger sensor 2 error	• Broken heat exchanger sensor 2 wire, poor connector connection • Indoor PCB is faulty	When a heat exchanger sensor 2 wire disconnection is detected while operation is stopped. (If a temperature of -28°C or lower is detected for 15 seconds, it is judged that the wire is disconnected.) (Not displayed during operation.)
4 times flash	ON	Stays OFF	E 9	Drain <sup>(3)</sup> trouble	• Defective drain pump (DM), broken drain pump wire • Anomalous float switch operation • Defective indoor PCB faulty	If the float switch OPEN is detected for 3 seconds continuously or if float switch connector or wire is disconnected.
6 times flash	ON	Stays OFF	E 16	Indoor fan motor error	• Defective fan motor, poor connector connection	When conditions for turning the indoor unit's fan motor on exist during air conditioner operation, an indoor unit fan motor speed of 300 (SRF : 150) rpm or lower is measured for 30 seconds or longer. (The air conditioner stops.)
Keeps flashing	1 time flash	8 times flash	E 38	Outdoor air temperature sensor error	• Broken outdoor air temp. sensor wire, poor connector connection • Outdoor main PCB is faulty	-55°C or lower is detected for 5 seconds continuously 3 times within 40 minutes after initial detection of this anomalous temperature. Or -55°C or higher is detected for within 20 seconds after power ON. (The compressor is stopped.)
Keeps flashing	2 times flash	8 times flash	E 37	Outdoor heat exchanger sensor error	• Broken heat exchanger sensor wire, poor connector connection • Outdoor main PCB is faulty	-55°C or lower is detected for 5 seconds continuously 3 times within 40 minutes after initial detection of this anomalous temperature. Or -55°C or higher is detected for within 20 seconds after power ON. (The compressor is stopped.)
Keeps flashing	4 times flash	8 times flash	E 39	Discharge pipe sensor error	• Broken discharge pipe sensor wire, poor connector connection • Outdoor main PCB is faulty	-25°C or lower is detected for 5 seconds continuously 3 times within 40 minutes after initial detection of this anomalous temperature. (The compressor is stopped.)
Keeps flashing	5 times flash	8 times flash	E 53	Outdoor suction pipe sensor error	• Broken suction pipe sensor wire, poor connector connection • Outdoor sub PCB is faulty	-55°C or lower is detected for 5 seconds continuously 3 times within 40 minutes after initial detection of this anomalous temperature. Or -55°C or higher is detected for within 20 seconds after power ON. (The compressor is stopped)
ON	1 time flash	1 time flash	E 42	Current cut	• Compressor locking, open phase on compressor output, short circuit on power transistor, service valve is closed	The compressor output current exceeds the set value during compressor start. (The air conditioner stops.)
ON	2 times flash	2 times flash	E 59	Trouble of outdoor unit	• Broken compressor wire • Compressor blockage	When there is an emergency stop caused by trouble in the outdoor unit, or the input current value is found to be lower than the set value. (The air conditioner stops.)
ON	3 times flash	3 times flash	E 58	Current safe stop	• Overload operation • Overcharge • Compressor locking	When the compressor command speed is lower than the set value and the current safe has operated. (the compressor stops)
ON	4 times flash	1 time flash	E 51	Power transistor error	• Broken power transistor	When the power transistor is judged breakdown while compressor starts. (The compressor is stopped.)
ON	5 times flash	5 times flash	E 36	Over heat of compressor	• Gas shortage, defective discharge pipe sensor, service valve is closed	When the value of the discharge pipe sensor exceeds the set value. (The air conditioner stops.)
ON	6 times flash	6 times flash	E 5	Error of signal transmission	• Defective power supply, Broken signal wire, defective indoor/outdoor sub PCB	When there is no signal between the indoor PCB and outdoor PCB for 10 seconds or longer (when the power is turned on), or when there is no signal for 7 minute 35 seconds or longer (during operation)(the compressor is stopped).
ON	7 times flash	Keeps flashing	E 48	Outdoor fan motor error	• Defective fan motor, poor connector connection	When the outdoor unit's fan motor speed continues for 30 seconds or longer at 75 rpm or lower. (3 times) (The air conditioner stops.)
ON	Keeps flashing	2 times flash	E 35	Cooling high pressure protection	• Overload operation, overcharge • Broken outdoor heat exchange sensor wire • Service valve is closed	When the value of the outdoor heat exchanger sensor exceeds the set value.
2 times flash	2 times flash	7 times flash	E 60	Rotor lock	• Defective compressor • Open phase on compressor • Defective outdoor PCB	If the compressor motor's magnetic pole positions cannot be correctly detected when the compressor starts. (The air conditioner stops.)
5 times flash	ON	2 times flash	E 47	Active filter voltage error	• Defective active filter	When the wrong voltage connected for the power supply. When the outdoor main PCB is faulty
7 times flash	ON	2 times flash	E 57	Refrigeration cycle system protective control	• Service valve is closed. • Refrigerant is insufficient	When refrigeration cycle system protective control operates.
—	—	4 times flash	E 45	Outdoor sub PCB communication error	• Outdoor sub PCB faulty • Poor connection of wire between outdoor sub PCB – main PCB	Communication error for 15 minutes: Detected more than 15 seconds 4 times
—	—	Stays OFF	E 1	Error of wired remote controller wiring	• Broken wired remote controller wire, defective indoor PCB	The wired remote controller wire Y is open. The wired remote controller wires X and Y are reversely connected. Noise is penetrating the wired remote controller lines. The wired remote controller or indoor PCB is faulty. (The communications circuit is faulty.)

Notes (1)The air conditioner cannot be restarted using the remote controller for 3 minutes after operation stops.

(2)The wired remote controller is optional parts.

(3)SRR series only.

**(6) Service mode (Trouble mode access function)**

This air conditioner is capable of recording error displays and protective stops (service data) which have occurred in the past. If self-diagnosis displays cannot be confirmed, it is possible to get a grasp of the conditions at the time trouble occurred by checking these service data.

**(a) Explanation of terms**

Term	Explanation
<b>Service mode</b>	The service mode is the mode where service data are displayed by flashing of the display lights when the operations in item (b) below are performed with the indoor controller.
<b>Service data</b>	These are the contents of error displays and protective stops which occurred in the past in the air conditioner system. Error display contents and protective stop data from past anomalous operations of the air conditioner system are saved in the indoor unit controller's non-volatile memory (memory which is not erased when the power goes off). There are two types of data, self-diagnosis data and stop data, described below.
<b>Self-diagnosis data</b>	These are the data which display the reason why a stop occurred when an error display (self-diagnosis display) occurred in an indoor unit. Data are recorded for up to 5 previous occurrences. Data which are older than the 5th previous occurrence are erased. In addition, data on the temperature of each sensor (room temperature, indoor heat exchanger, outdoor heat exchanger, outdoor air temperature, discharge pipe), remote controller information (operation switching, fan speed switching) are recorded when trouble occurs, so more detailed information can be checked.
<b>Stop data</b>	These are the data which display the reason by a stop occurred when the air conditioning system performed protective stops, etc. in the past. Even if stop data alone are generated, the system restarts automatically. (After executing the stop mode while the display is normal, the system restarts automatically.) Data for up to 10 previous occasions are stored. Data older than the 10th previous occasion are erased. ( Important) In cases where transient stop data only are generated, the air conditioner system may still be normal. However, if the same protective stop occurs frequently (3 or more times), it could lead to customer complaints.

**(b) Service mode display procedure**

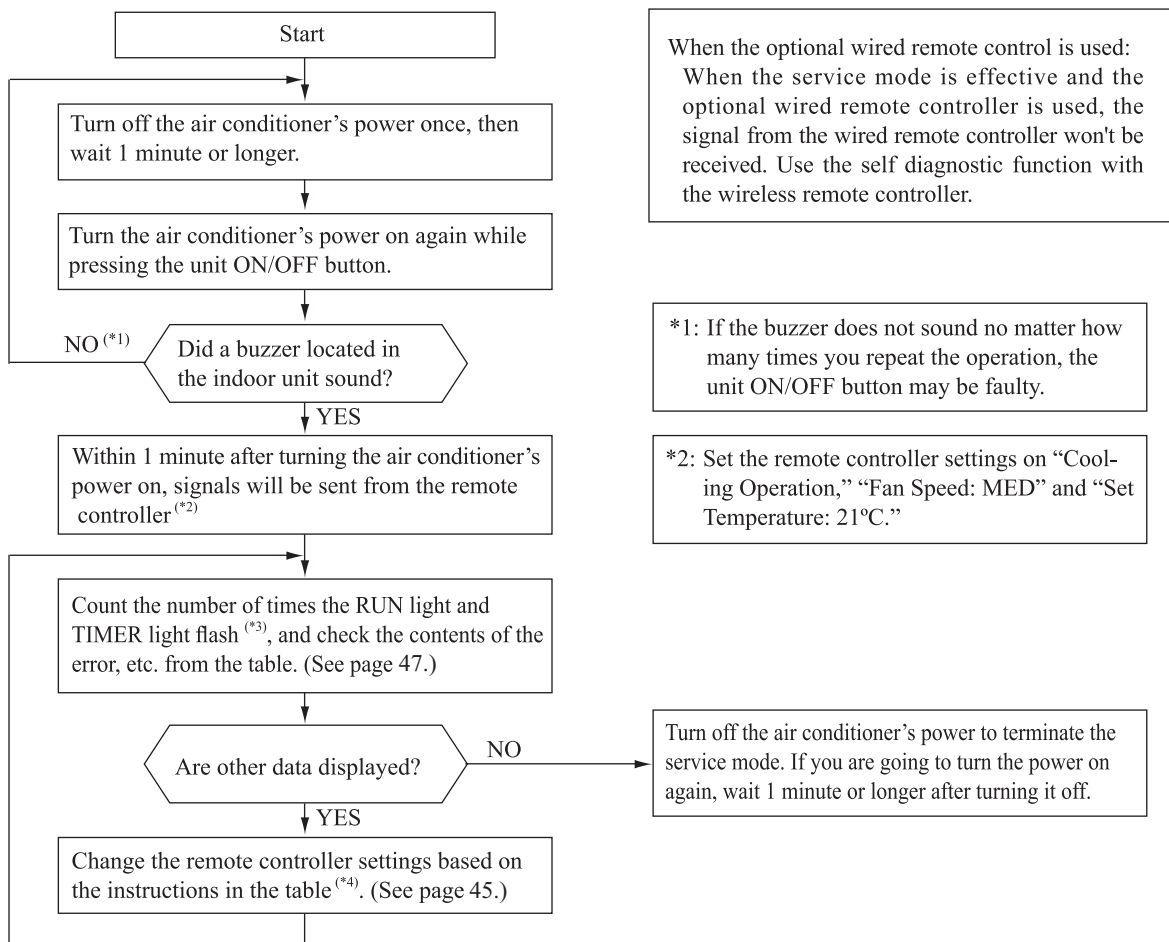

\*3: To count the number of flashes in the service mode, count the number of flashes after the light lights up for 1.5 second initially (start signal). (The time that the light lights up for 1.5 second (start signal) is not counted in the number of flashes.)

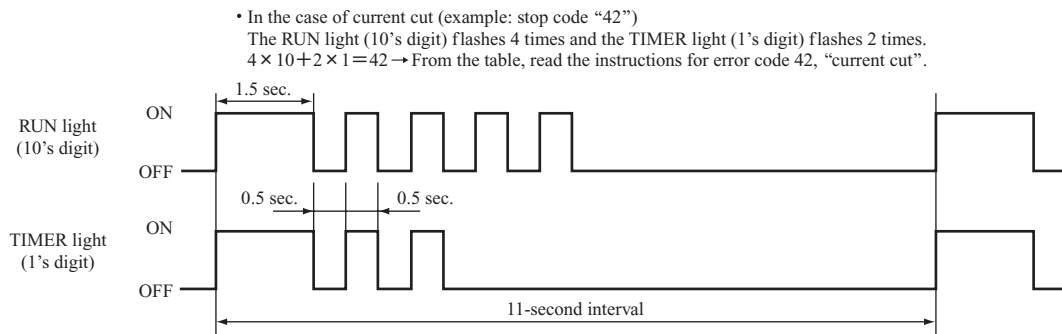

\*4: When in the service mode, when the remote controller settings (operation switching, fan speed switching, temperature setting) are set as shown in the following table and sent to the air conditioner unit, the unit switches to display of service data.

**1) Self-diagnosis data**

What are Self- .....These are control data (reasons for stops, temperature at each sensor, remote controller information) diagnosis Data? from the time when there were error displays (abnormal stops) in the indoor unit in the past.

Data from up to 5 previous occasions are stored in memory. Data older than the 5th previous occasion are erased.

The temperature setting indicates how many occasions previous to the present setting the error display data are and the operation switching and fan speed switching data show the type of data.

Remote controller setting		Contents of output data
Operation switching	Fan speed switching	
Cooling	MED	Displays the reason for stopping display in the past (error code).
	HI	Displays the room temperature sensor temperature at the time the error code was displayed in the past.
	AUTO	Displays the indoor heat exchanger sensor temperature at the time the error code was displayed in the past.
Heating	LO	Displays the remote controller information at the time the error code was displayed in the past.
	MED	Displays the outdoor air temperature sensor temperature at the time the error code was displayed in the past.
	HI	Displays the outdoor heat exchanger sensor temperature at the time the error code was displayed in the past.
	AUTO	Displays the discharge pipe sensor temperature at the time the error code was displayed in the past.

Remote controller setting	Indicates the number of occasions previous to the present the error display data are from.
Temperature setting	
21°C	1 time previous (previous time)
22°C	2 times previous
23°C	3 times previous
24°C	4 times previous
25°C	5 times previous

**Only for indoor heat exchanger sensor 2**

Remote controller setting	Indicates the number of occasions previous to the present the error display data are from.
Temperature setting	
26°C	1 time previous (previous time)
27°C	2 times previous
28°C	3 times previous
29°C	4 times previous
30°C	5 times previous

(Example)

Remote controller setting			Displayed data
Operation switching	Fan speed switching	Temperature setting	
Cooling	MED	21°C	Displays the reason for the stop (error code) the previous time an error was displayed.
		22°C	Displays the reason for the stop (error code) 2 times previous when an error was displayed.
		23°C	Displays the reason for the stop (error code) 3 times previous when an error was displayed.
		24°C	Displays the reason for the stop (error code) 4 times previous when an error was displayed.
		25°C	Displays the reason for the stop (error code) 5 times previous when an error was displayed.

## 2) Stop data

Remote controller setting			Displayed data
Operation switching	Fan speed switching	Temperature setting	
Cooling	LO	21°C	Displays the reason for the stop (stop code) the previous time when the air conditioner was stopped by protective stop control.
		22°C	Displays the reason for the stop (stop code) 2 times previous when the air conditioner was stopped by protective stop control.
		23°C	Displays the reason for the stop (stop code) 3 times previous when the air conditioner was stopped by protective stop control.
		24°C	Displays the reason for the stop (stop code) 4 times previous when the air conditioner was stopped by protective stop control.
		25°C	Displays the reason for the stop (stop code) 5 times previous when the air conditioner was stopped by protective stop control.
		26°C	Displays the reason for the stop (stop code) 6 times previous when the air conditioner was stopped by protective stop control.
		27°C	Displays the reason for the stop (stop code) 7 times previous when the air conditioner was stopped by protective stop control.
		28°C	Displays the reason for the stop (stop code) 8 times previous when the air conditioner was stopped by protective stop control.
		29°C	Displays the reason for the stop (stop code) 9 times previous when the air conditioner was stopped by protective stop control.
		30°C	Displays the reason for the stop (stop code) 10 times previous when the air conditioner was stopped by protective stop control.

(c) **Error code, stop code table** (Assignment of error codes and stop codes is done in common for all models.)

Number of flashes when in service mode		Stop code or Error code	Error content	Cause	Occurrence conditions	Error display	Auto recovery
RUN light (10's digit)	TIMER light (1's digit)						
OFF	OFF	0	Normal	—	—	—	—
	5 time flash	05	Can not receive signals for 35 seconds (if communications have recovered)	Power supply is faulty. Power supply cables and signal lines are improperly wired. Indoor or outdoor sub PCB are faulty	When 35 seconds passes without communications signals from either the outdoor unit or the indoor unit being detected correctly.	○	—
3 time flash	5 time flash	35	Cooling high pressure control	Cooling overload operation. Outdoor unit fan speed drops. Outdoor heat exchanger sensor is short circuit.	When the outdoor heat exchanger sensor's value exceeds the set value.	○ (5 times)	○
	6 time flash	36	Compressor overheat 110°C	Refrigerant is insufficient. Discharge pipe sensor is faulty. Service valve is closed.	When the discharge pipe sensor's value exceeds the set value.	○ (2 times)	○
	7 time flash	37	Outdoor heat exchanger sensor is abnormal	Outdoor heat exchanger sensor wire is disconnected. Connector connections are poor. Outdoor main PCB is faulty	-55°C or lower is detected for 5 seconds continuously 3 times within 40 minutes after initial detection of this anomalous temperature. Or -55°C higher is detected for 5 seconds continuously within 20 seconds after power ON.	○ (3 times)	○
	8 time flash	38	Outdoor air temperature sensor is abnormal	Outdoor air temperature sensor wire is disconnected. Connector connections are poor. Outdoor main PCB is faulty	-55°C or lower is detected for 5 seconds continuously 3 times within 40 minutes after initial detection of this anomalous temperature. Or -55°C higher is detected for 5 seconds continuously within 20 seconds after power ON.	○ (3 times)	○
	9 time flash	39	Discharge pipe sensor is abnormal (anomalous stop)	Discharge pipe sensor wire is disconnected. Connector connections are poor. Outdoor main PCB is faulty	-25°C or lower is detected for 5 seconds continuously 3 times within 40 minutes after initial detection of this anomalous temperature.	○ (3 times)	○
4 time flash	2 time flash	42	Current cut	Compressor lock. Compressor wiring short circuit. Compressor output is open phase. Outdoor main PCB is faulty Service valve is closed. Electronic expansion valve is faulty. Compressor is faulty.	Compressor start fails 42 times in succession and the reason for the final failure is current cut.	○ (2 times)	○
	5 time flash	45	Anomalous outdoor sub PCB communication	Outdoor sub PCB faulty. Poor connection of wire between outdoor sub PCB-main PCB.	Communication error for 15 minutes: Detected more than 15 seconds 4 times.	○	○
	7 time flash	47	Active filter voltage error	Defective active filter.	When the wrong voltage connected for the power supply. When the outdoor main PCB is faulty.	○	—
	8 time flash	48	Outdoor unit's fan motor is abnormal	Outdoor fan motor is faulty. Connector connections are poor. Outdoor main PCB is faulty.	When a fan speed of 75 rpm or lower continues for 30 seconds or longer.	○ (3 times)	○
5 time flash	1 time flash	51	Short circuit in the power transistor (high side) Current cut circuit breakdown	Outdoor main PCB is faulty Power transistor is damaged.	When it is judged that the power transistor was damaged at the time the compressor started.	○	—
	3 time flash	53	Suction pipe sensor is abnormal	Suction pipe sensor wire is disconnected. Connector connections are poor. Outdoor sub PCB is faulty.	-55°C or lower is detected for 5 seconds continuously 3 times within 40 minutes after initial detection of this anomalous temperature. Or -55°C higher is detected for 5 seconds continuously within 20 seconds after compressor ON.	○ (3 times)	○
	7 time flash	57	Refrigeration cycle system protective control	Service valve is closed. Refrigerant is insufficient.	When refrigeration cycle system protective control operates.	○ (3 times)	○
	8 time flash	58	Current safe	Refrigerant is overcharge. Compressor lock. Overload operation.	When there is a current safe stop during operation.	—	○
	9 time flash	59	Compressor wiring is unconnection Voltage drop	Compressor wiring is disconnected. Power transistor is damaged. Power supply construction is defective. Outdoor main PCB is faulty. Compressor is faulty.	When the current is 1A or less at the time the compressor started. When the power supply voltage drops during operation.	○	○
6 time flash	OFF	60	Rotor lock	Compressor is faulty. Compressor output is open phase. Electronic expansion valve is faulty. Overload operation. Outdoor main PCB is faulty.	After the compressor starts, when the compressor stops due to rotor lock.	○ (2 times)	○
	1 time flash	61	Connection lines between the indoor and outdoor units are faulty	Connection lines are faulty. Indoor or outdoor sub PCB are faulty.	When 10 seconds passes after the power is turned on without communications signals from the indoor or outdoor unit being detected correctly.	○	—
	2 time flash	62	Serial transmission error	Indoor or outdoor sub PCB are faulty. Noise is causing faulty operation.	When 7 minute 35 seconds passes without communications signals from either the outdoor unit or the indoor unit being detected correctly.	○	—
8 time flash	OFF	80	Indoor unit's fan motor is abnormal	Indoor fan motor is faulty. Connector connections are poor. Indoor PCB is faulty.	When the indoor unit's fan motor is detected to be running at 300 (SRF : 150) rpm or lower speed with the fan motor in the ON condition while the air conditioner is running.	○	—
	2 time flash	82	Indoor heat exchanger sensor is abnormal (anomalous stop)	Indoor heat exchanger sensor wire is disconnected. Connector connections are poor	When a temperature of -28°C or lower is sensed continuously for 40 minutes during heating operation. (the compressor stops).	○	—
	4 time flash	84	Anti-condensation control	High humidity condition. Humidity sensor is faulty.	Anti-condensation prevention control is operating.	—	○
	5 time flash	85	Anti-frost control	Indoor unit fan speed drops. Indoor heat exchanger sensor is broken wire.	When the anti-frost control operates and the compressor stops during cooling operation.	—	○
	6 time flash	86	Heating high pressure control	Heating overload operation. Indoor unit fan speed drops. Indoor heat exchanger sensor is short circuit.	When high pressure control operates during heating operation and the compressor stops.	—	○

Note (1) The number of flashes when in the Service Mode do not include the 1.5 second period when the lights light up at first (starting signal). (See the example shown below.)

• In the case of current cut (example: stop code "42")  
 The RUN light (10's digit) flashes 4 times and the TIMER light (1's digit) flashes 2 times.  
 $4 \times 10 + 2 \times 1 = 42 \rightarrow$  From the table, read the instructions for error code 42, "current cut".

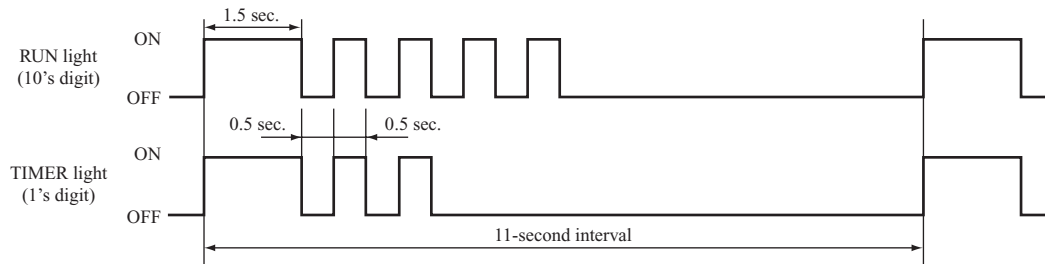

- (2) Error display:   
 – Is not displayed. (automatic recovery only)  
 Displayed.  
 If there is a ( ) displayed, the error display shows the number of times that an auto recovery occurred for the same reason has reached the number of times in ( ).  
 If no ( ) is displayed, the error display shows that the trouble has occurred once.
- (3) Auto Recovery:   
 – Does not occur  
 Auto recovery occurs.

**(d) Remote controller information tables**

1) Operation switching

Display pattern when in service mode RUN light (Operation switching)	Operation switching when there is an abnormal stop
0	AUTO
1	DRY
2	COOL
3	FAN
4	HEAT

2) Fan speed switching

Display pattern when in service mode TIMER light (Fan speed switching)	Fan speed switching when there is an abnormal stop
0	AUTO
2	HI
3	MED
4	LO
6	HI POWER
7	ECONO

\* If no data are recorded (error code is normal), the information display in the remote controller becomes as follows.

Remote controller setting	Display when error code is normal.
Operation switching	AUTO
Fan speed switching	AUTO

(Example): Operation switching, fan speed switching, cooling HI

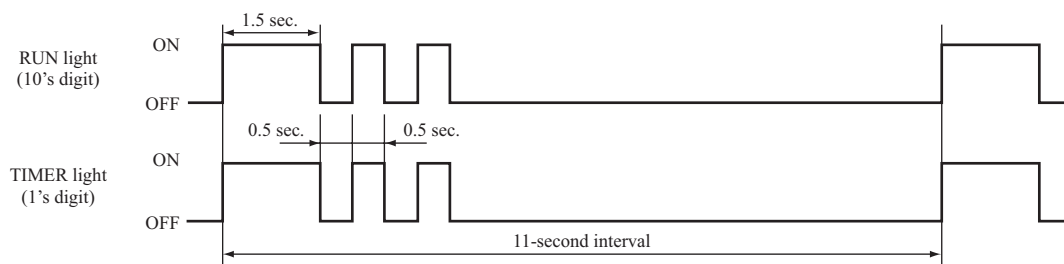



(e) Room temperature sensor, indoor heat exchanger sensor, outdoor air temperature sensor, outdoor heat exchanger sensor , suction pipe sensor table

Units: °C

Buzzer sound	RUN light (10's digit)	TIMER light (1's digit)										
		0	1	2	3	4	5	6	7	8	9	
Yes (sounds for 0.1 second)	6	-60	-61	-62	-63	-64						
	5	-50	-51	-52	-53	-54	-55	-56	-57	-58	-59	
	4	-40	-41	-42	-43	-44	-45	-46	-47	-48	-49	
	3	-30	-31	-32	-33	-34	-35	-36	-37	-38	-39	
	2	-20	-21	-22	-23	-24	-25	-26	-27	-28	-29	
	1	-10	-11	-12	-13	-14	-15	-16	-17	-18	-19	
	0		-1	-2	-3	-4	-5	-6	-7	-8	-9	
No (does not sound)	0	0	1	2	3	4	5	6	7	8	9	
	1	10	11	12	13	14	15	16	17	18	19	
	2	20	21	22	23	24	25	26	27	28	29	
	3	30	31	32	33	34	35	36	37	38	39	
	4	40	41	42	43	44	45	46	47	48	49	
	5	50	51	52	53	54	55	56	57	58	59	
	6	60	61	62	63	64	65	66	67	68	69	
	7	70	71	72	73	74	75	76	77	78	79	
	8	80	81	82	83	84	85	86	87	88	89	
	9	90	91	92	93	94	95	96	97	98	99	

\* If no data are recorded (error code is normal), the display for each sensor becomes as shown below.

Sensor name	Sensor value displayed when the error code is normal
Room temperature sensor	-64°C
Indoor heat exchanger sensor	-64°C
Outdoor air temperature sensor	-64°C
Outdoor heat exchanger sensor	-64°C
Outdoor suction pipe sensor	-64°C

(Example) Room temperature, indoor heat exchanger, outdoor air temperature, outdoor heat exchanger, outdoor suction pipe : “-9°C”

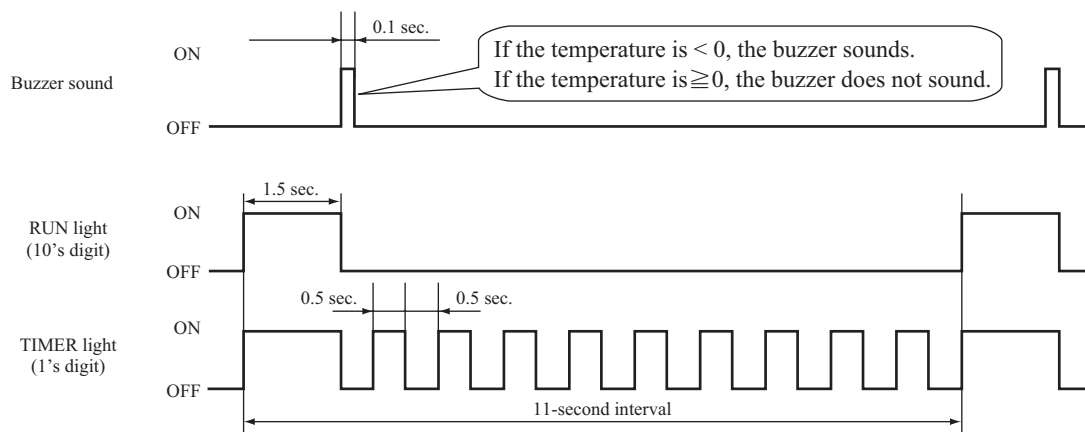



(f) Discharge pipe sensor table

Buzzer sound		TIMER light (1's digit)		Units: °C									
		0	1	2	3	4	5	6	7	8	9		
Yes (sounds for 0.1 second)	3	-60	-62	-64									
	2	-40	-42	-44	-46	-48	-50	-52	-54	-56	-58		
	1	-20	-22	-24	-26	-28	-30	-32	-34	-36	-38		
	0	/	-2	-4	-6	-8	-10	-12	-14	-16	-18		
No (does not sound)	0	0	2	4	6	8	10	12	14	16	18		
	1	20	22	24	26	28	30	32	34	36	38		
	2	40	42	44	46	48	50	52	54	56	58		
	3	60	62	64	66	68	70	72	74	76	78		
	4	80	82	84	86	88	90	92	94	96	98		
	5	100	102	104	106	108	110	112	114	116	118		
	6	120	122	124	126	128	130	132	134	136	138		
	7	140	142	144	146	148	150						

\* If no data are recorded (error code is normal), the display for each sensor becomes as shown below.

Sensor name	Sensor value displayed when the error code is normal
Discharge pipe sensor	-64°C

(Example) Discharge pipe temperature: "122°C"

\* In the case of discharge pipe data, multiply the reading value by 2. (Below, 61 x 2 = "122°C")

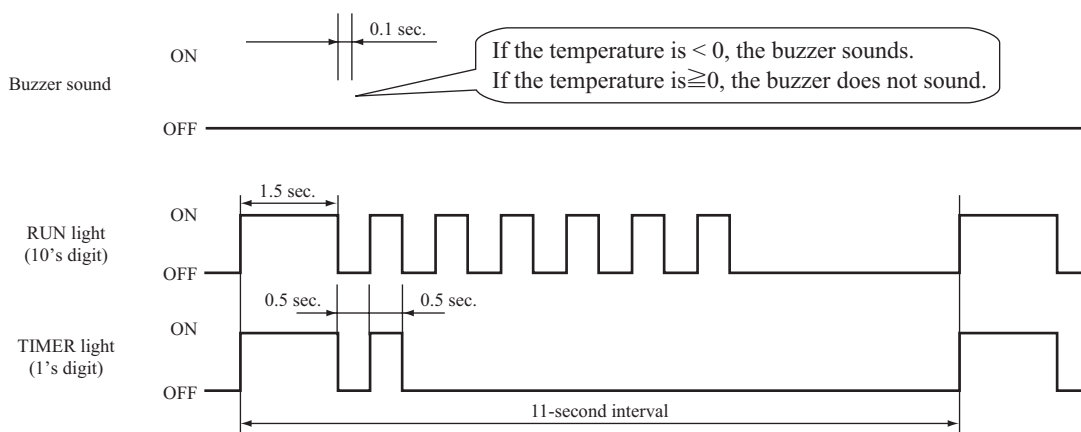

## Service data record form

Customer		Model						
Date of investigation								
Machine name								
Content of complaint								
Remote controller settings			Content of displayed data	Display results			Display content	
Temperature setting	Operation switching	Fan speed switching		Buzzer (Yes/No.)	RUN light (Times)	TIMER light (Times)		
21	Cooling	MED	Error code on previous occasion.	/				
		HI	Room temperature sensor on previous occasion.					
		AUTO	Indoor heat exchanger sensor 1 on previous occasion.					
	Heating	LO	Remote controller information on previous occasion.	/				
		MED	Outdoor air temperature sensor on previous occasion.					
		HI	Outdoor heat exchanger sensor on previous occasion.					
	AUTO	Discharge pipe sensor on previous occasion.						
26	Cooling	AUTO	Indoor heat exchanger sensor 2 on previous occasion.					
22	Cooling	MED	Error code on second previous occasion.	/				
		HI	Room temperature sensor on second previous occasion.					
		AUTO	Indoor heat exchanger sensor 1 on second previous occasion.					
	Heating	LO	Remote controller information on second previous occasion.	/				
		MED	Outdoor air temperature sensor on second previous occasion.					
		HI	Outdoor heat exchanger sensor on second previous occasion.					
	AUTO	Discharge pipe sensor on second previous occasion.						
27	Cooling	AUTO	Indoor heat exchanger sensor 2 on second occasion.					
23	Cooling	MED	Error code on third previous occasion.	/				
		HI	Room temperature sensor on third previous occasion.					
		AUTO	Indoor heat exchanger sensor 1 on third previous occasion.					
	Heating	LO	Remote controller information on third previous occasion.	/				
		MED	Outdoor air temperature sensor on third previous occasion.					
		HI	Outdoor heat exchanger sensor on third previous occasion.					
	AUTO	Discharge pipe sensor on third previous occasion.						
28	Cooling	AUTO	Indoor heat exchanger sensor 2 on third occasion.					
24	Cooling	MED	Error code on fourth previous occasion.	/				
		HI	Room temperature sensor on fourth previous occasion.					
		AUTO	Indoor heat exchanger sensor 1 on fourth previous occasion.					
	Heating	LO	Remote controller information on fourth previous occasion.	/				
		MED	Outdoor air temperature sensor on fourth previous occasion.					
		HI	Outdoor heat exchanger sensor on fourth previous occasion.					
	AUTO	Discharge pipe sensor on fourth previous occasion.						
29	Cooling	AUTO	Indoor heat exchanger sensor 2 on fourth occasion.					
25	Cooling	MED	Error code on fifth previous occasion.	/				
		HI	Room temperature sensor on fifth previous occasion.					
		AUTO	Indoor heat exchanger sensor 1 on fifth previous occasion.					
	Heating	LO	Remote controller information on fifth previous occasion.	/				
		MED	Outdoor air temperature sensor on fifth previous occasion.					
		HI	Outdoor heat exchanger sensor on fifth previous occasion.					
	AUTO	Discharge pipe sensor on fifth previous occasion.						
30	Cooling	AUTO	Indoor heat exchanger sensor 2 on fifth occasion.					
21	Cooling	Lo	Stop code on previous occasion.					
22			Stop code on second previous occasion.					
23			Stop code on third previous occasion.					
24			Stop code on fourth previous occasion.					
25			Stop code on fifth previous occasion.					
26			Stop code on sixth previous occasion.					
27			Stop code on seventh previous occasion.					
28			Stop code on eighth previous occasion.					
29			Stop code on ninth previous occasion.					
30			Stop code on tenth previous occasion.					
Judgment							Examiner	
Remarks								

Note (1) In the case of indoor heat exchanger sensor 2, match from 26 to 30 the temperature setting of remote controller. (Refer to page 45)

(7) Inspection procedures corresponding to detail of trouble

**Sensor error**

[ Broken sensor wire, connector poor connection ]

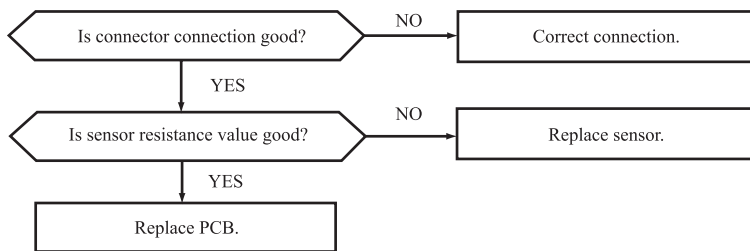

◆ Discharge pipe sensor temperature characteristics

◆ Sensor temperature characteristics (Room temp., indoor heat exchanger temp., outdoor heat exchanger temp., outdoor air temp., outdoor suction pipe temp.)

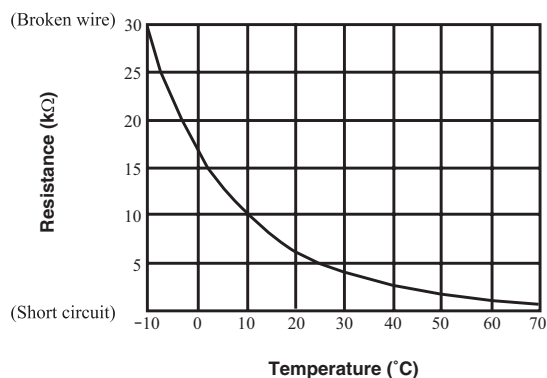
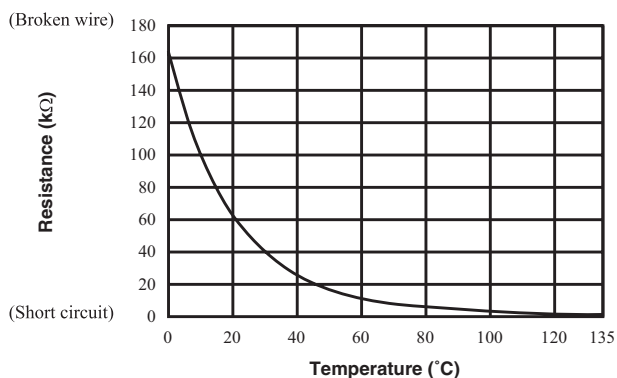

**Indoor fan motor error**

[ Defective fan motor, connector poor connection, defective indoor PCB ]

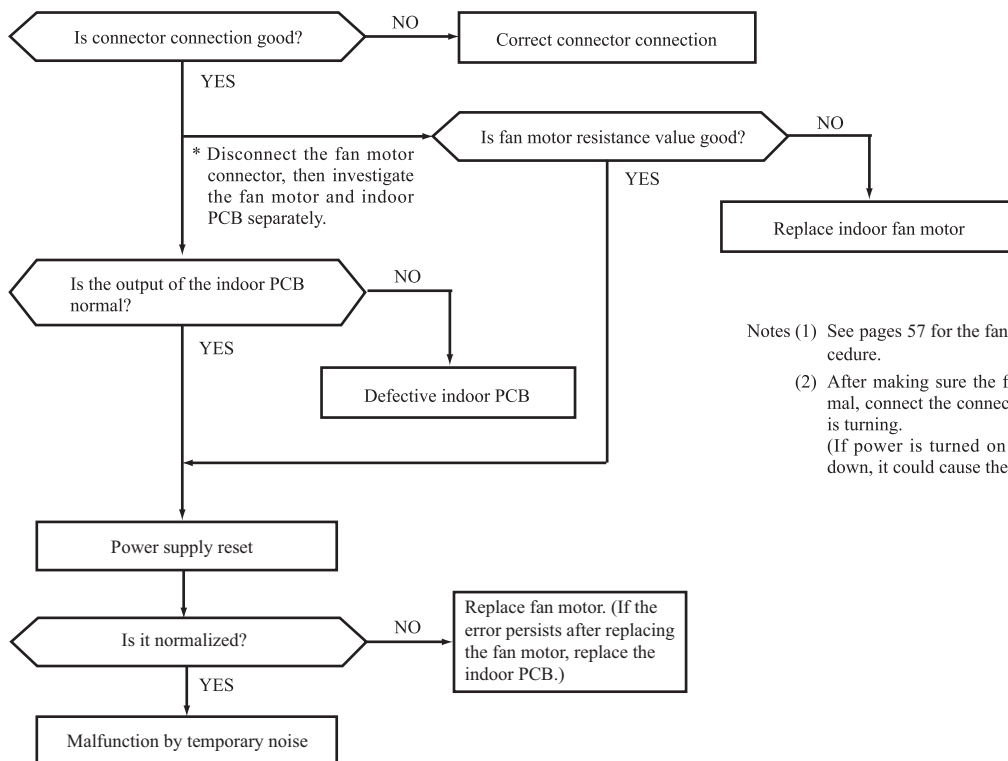

Notes (1) See pages 57 for the fan motor and indoor PCB check procedure.  
 (2) After making sure the fan motor and indoor PCB are normal, connect the connectors and confirm that the fan motor is turning.  
 (If power is turned on while one or the other is broken down, it could cause the other to break down also.)

## Current cut

[Compressor lock, Compressor wiring short circuit, Compressor output is open phase, Outdoor PCB is faulty, Service valve is closed, EEV is faulty, Compressor faulty.]

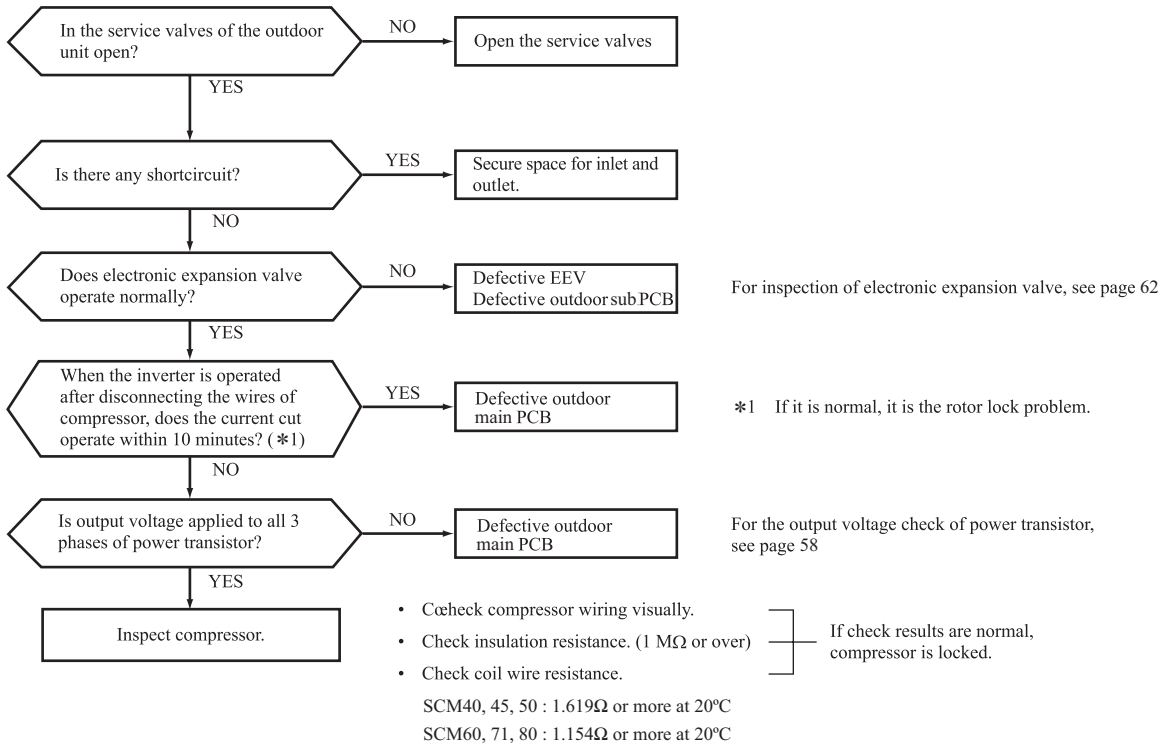

## Current safe stop

[Overload operation, compressor lock, overcharge]

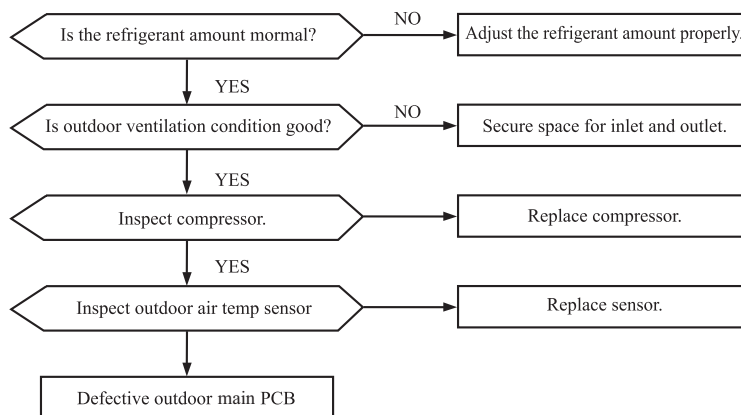

## Over heat of compressor

[ Gas shortage, defective discharge pipe sensor ]

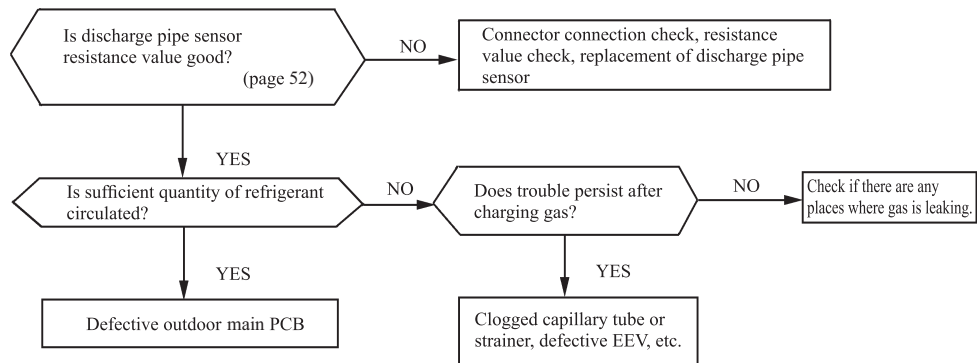

## Error of signal transmission

[ Wiring error including power cable, defective indoor/outdoor PCB ]

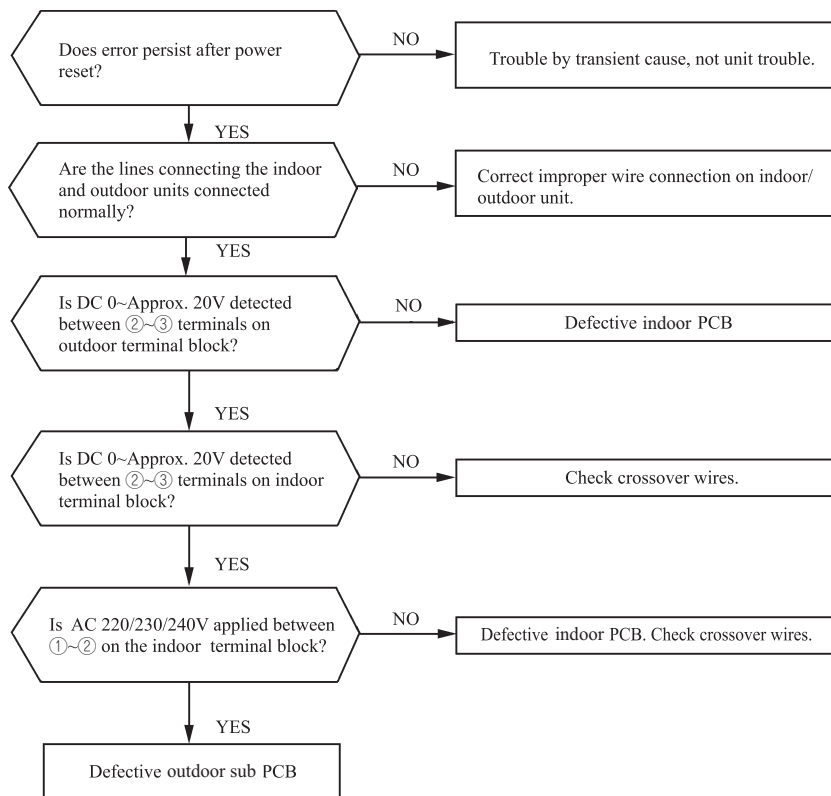

## Trouble of outdoor unit

[ Insufficient refrigerant amount, Faulty power transistor, Broken compressor wire ]  
 [ Service valve close, Defective EEV, Defective outdoor PCB ]

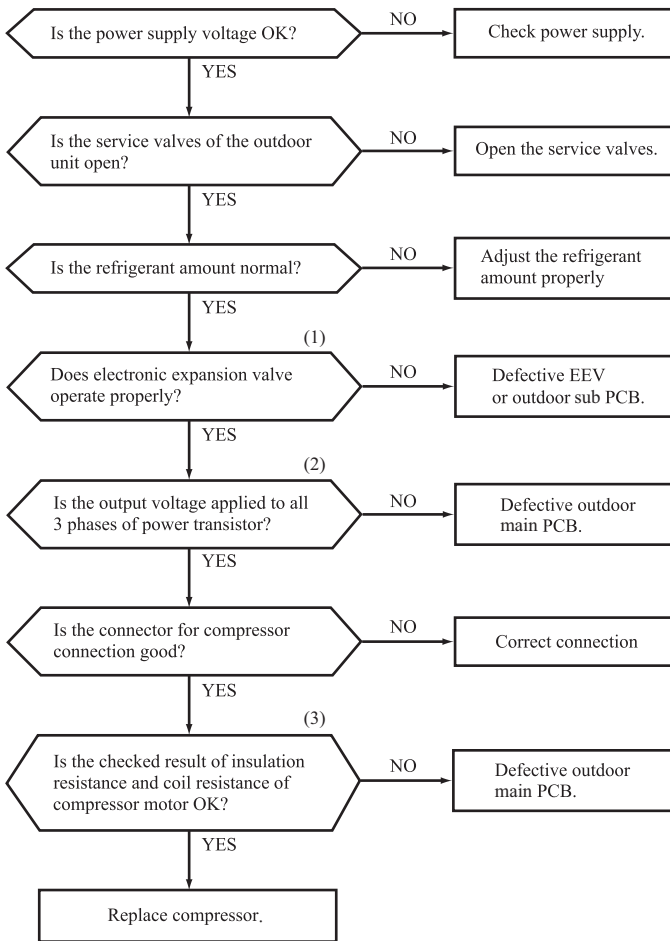

Proper power supply voltages are as follows.  
 (At the power supply outlet)  
 220V : 198~242V  
 230V : 207~253V  
 240V : 216~264V

- ◆ Judgment of refrigerant quantity
- (1) Phenomenon of insufficient refrigerant
    - (a) Loss of capacity
    - (b) Poor defrosting  
(Frost is not removed completely.)
    - (c) Longer time of hot keep  
(5 minute or more)  
(Normal time: Approx. 1 – 1 minute and 30 seconds)

Notes (1) For inspection of electronic expansion valve, see page 62  
 (2) For the output voltage check of power transistor, see page 58  
 (3) Check coil resistance, See pages 53.

## Outdoor fan motor error

[ Defective fan motor, connector poor connection, defective outdoor PCB ]

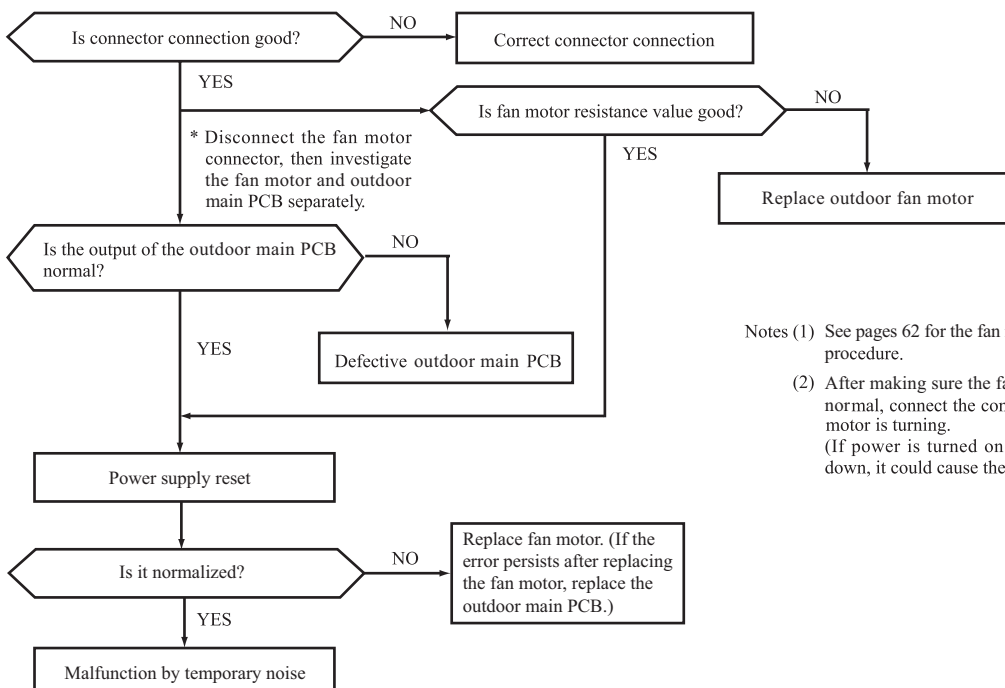

Notes (1) See pages 62 for the fan motor and outdoor main PCB check procedure.  
 (2) After making sure the fan motor and outdoor main PCB are normal, connect the connectors and confirm that the fan motor is turning.  
 (If power is turned on while one or the other is broken down, it could cause the other to break down also.)

## Rotor lock

[Defective compressor, defective outdoor PCB]

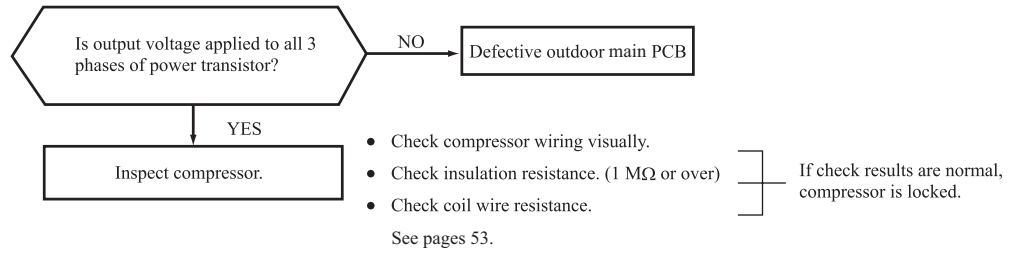

## Drain abnormality (SRR only)

[Drain piping defective, pump defect, float switch, indoor PCB]

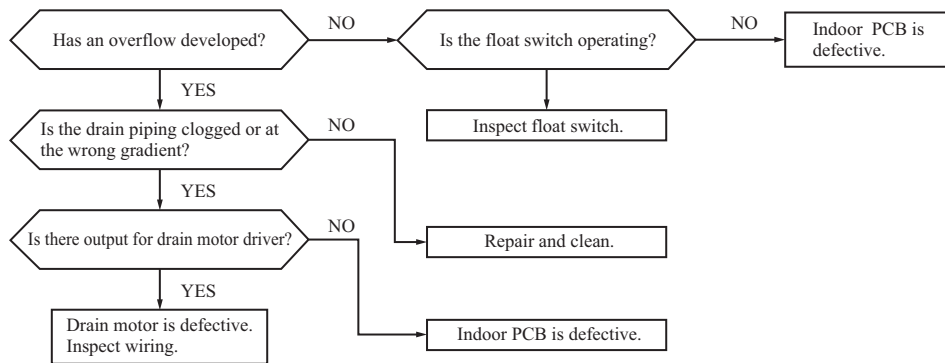

### (8) Phenomenon observed after shortcircuit, wire breakage on sensor

#### (a) Indoor unit

Sensor	Operation mode	Phenomenon	
		Shortcircuit	Disconnected wire
Room temperature sensor	Cooling	Release of continuous compressor operation command.	Continuous compressor operation command is not released.
	Heating	Continuous compressor operation command is not released.	Release of continuous compressor operation command.
Heat exchanger sensor	Cooling	System can be operated normally.	Continuous compressor operation command is not released. (Anti-frosting)
	Heating	High pressure control mode (Compressor stop command)	Hot keep (Indoor fan stop)
Humidity sensor <sup>(1)</sup>	Cooling	Refer to the table below.	Refer to the table below.
	Heating	Normal system operation is possible.	

Note (1) SRK35, 50ZJ-S, 50, 60ZJX-S, SRF25, 35, 50ZJX-S only

#### ■ Humidity sensor operation

Failure mode	Control input circuit reading	Air conditioning system operation
Disconnected wire	① Disconnected wire	Humidity reading is 0%
	② Disconnected wire	
	①② Disconnected wire	
Short Circuit	① and ② are short circuited	Humidity reading is 100%

Remark: Do not perform a continuity check of the humidity sensor with a tester. If DC current is applied, it could damage the sensor.

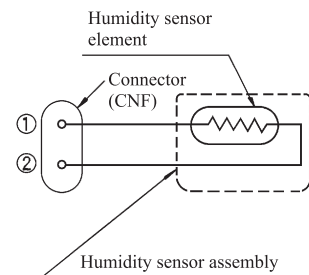

**(b) Outdoor unit**

Sensor	Operation mode	Phenomenon	
		Shortcircuit	Disconnected wire
Heat exchanger sensor	Cooling	System can be operated normally.	Compressor stop.
	Heating	Defrosting is not performed.	Defrosting is performed for 10 minutes at approx. 40 minutes.
Outdoor air temperature sensor	Cooling	System can be operated normally.	Compressor stop.
	Heating	Defrosting is not operated.	Defrosting is performed for 10 minutes at approx. 40 minutes.
Discharge pipe sensor	All modes	Compressor overload protection is disabled. (Can be operated.)	Compressor stop

**(9) Checking the indoor electrical equipment**

**(a) Indoor PCB check procedure**

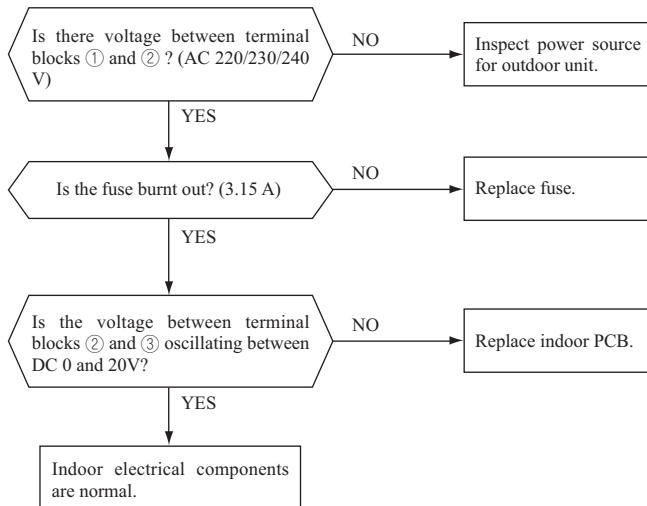

**(b) Indoor unit fan motor check procedure**

This is a diagnostic procedure for determining if the indoor unit's fan motor or the indoor PCB is broken down.

**1) Indoor PCB output check**

- a) Turn off the power.
- b) Remove the front panel, then disconnect the fan motor lead wire connector.
- c) Turn on the power. If the unit operates when the ON/OFF button is pressed, if trouble is detected after the voltages in the following figure are output for approximately 30 seconds, it means that the indoor PCB is normal and the fan motor is broken down.

If the voltages in the following figure are not output at connector pins No. ①, ④ and ⑤, the indoor PCB has failed and the fan motor is normal.

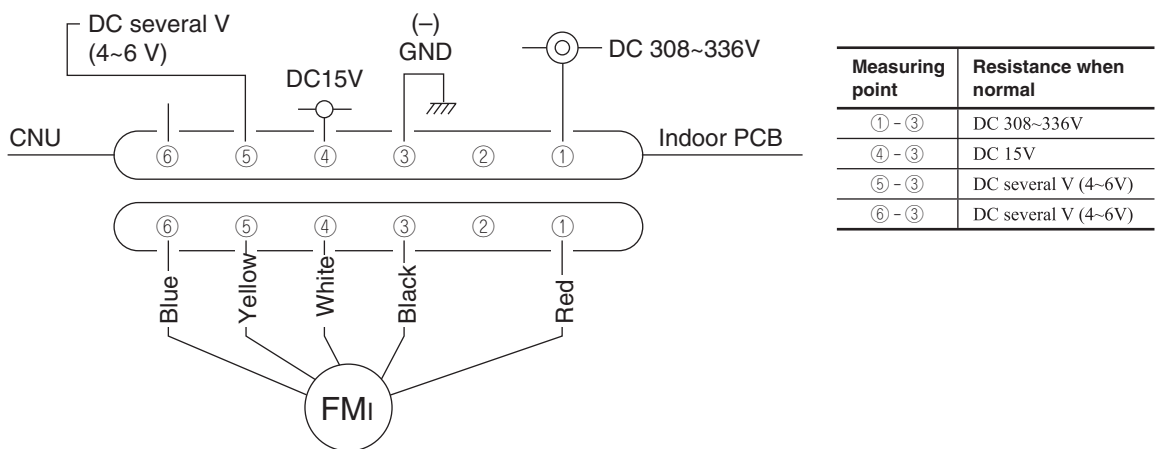

**2) Fan motor resistance check**

Measuring point	Resistance when normal
① - ③ (Red - Black)	20 MΩ or higher
④ - ③ (White - Black)	20 kΩ or higher

- Notes (1) Remove the fan motor and measure it without power connected to it.  
 (2) If the measured value is below the value when the motor is normal, it means that the fan motor is faulty.



**(C) Power transistor inspection procedure**

[Use a tester with a needle indicator for the inspection. (Do not use a digital tester. Check in the AC 300 volt range.)]

(1) If there is a self-diagnosis display, inspect the compressor system (burns, wiring mistakes, etc.) If no problems are found, check the output of the power transistor.

**(2) Output inspection procedure**

Disconnect the terminals for the compressor.

If an output such as the one shown in the figure on the below can be measured, the power transistor and the circuit board for the outdoor unit are normal.

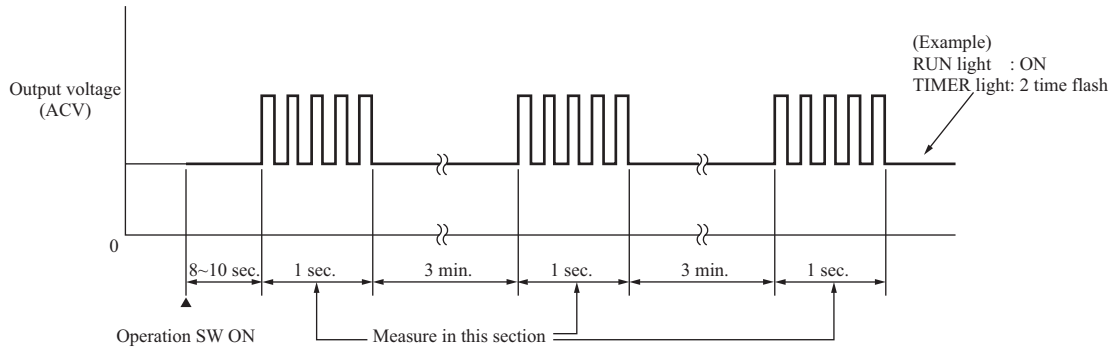

**(10) How to make sure of wireless remote controller**

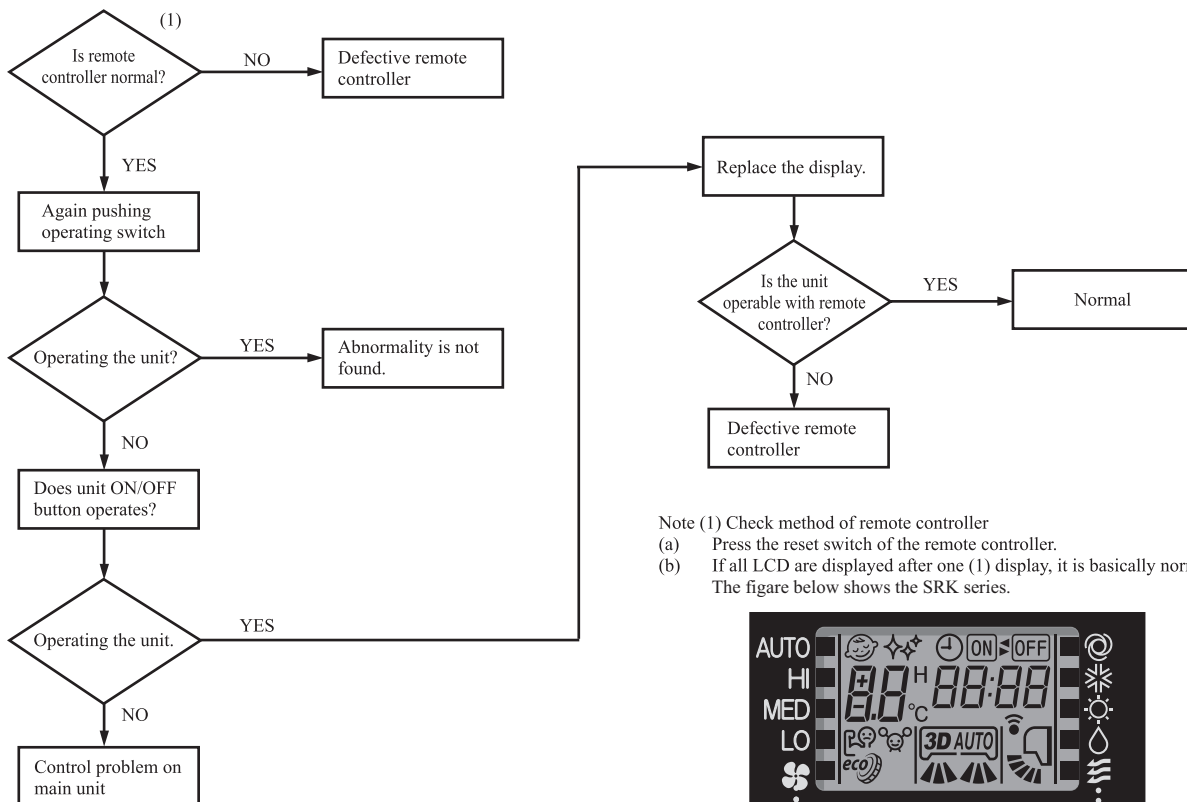

Note (1) Check method of remote controller  
 (a) Press the reset switch of the remote controller.  
 (b) If all LCD are displayed after one (1) display, it is basically normal. The figure below shows the SRK series.



**⚠ CAUTION- HIGH VOLTAGE**

High voltage is produced in the control box. Don't touch electrical parts in the control box for 5 minutes after the unit is stopped.

**Color Marks**

Mark	Color
BK	Black
RD	Red
WH	White
OR	Orange
BR	Brown
YE	Yellow
Y/G	Yellow/Green

Power supply  
1 Phase  
220-240V 50Hz

◆ **Inspection power transistor**  
Remove the fasten terminal and test output voltage

(11) Outdoor unit inspection points  
Models SCM40ZJ-S,45ZJ-S

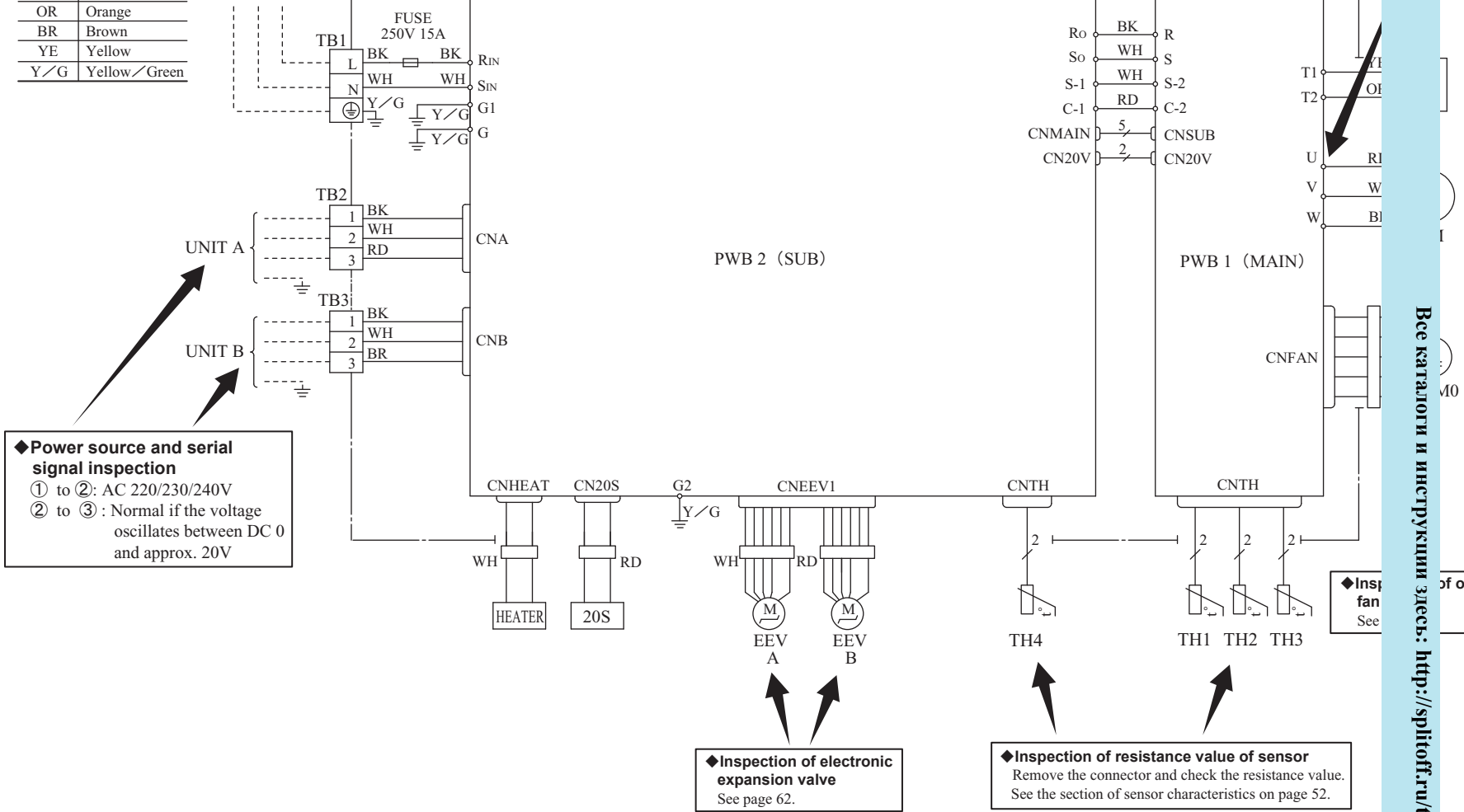

◆ **Power source and serial signal inspection**  
① to ②: AC 220/230/240V  
② to ③: Normal if the voltage oscillates between DC 0 and approx. 20V

◆ **Inspection of electronic expansion valve**  
See page 62.

◆ **Inspection of resistance value of sensor**  
Remove the connector and check the resistance value. See the section of sensor characteristics on page 52.

◆ **Inspection of fan**  
See page 62.

Без каталог и инструкции здесь: <http://splitoff.ru/ehd-doc.html>

### ⚠ CAUTION- HIGH VOLTAGE

High voltage is produced in the control box. Don't touch electrical parts in the control box for 5 minutes after the unit is stopped.

#### Color Marks

Mark	Color
BK	Black
BL	Blue
RD	Red
WH	White
OR	Orange
BR	Brown
YE	Yellow
Y/G	Yellow/Green

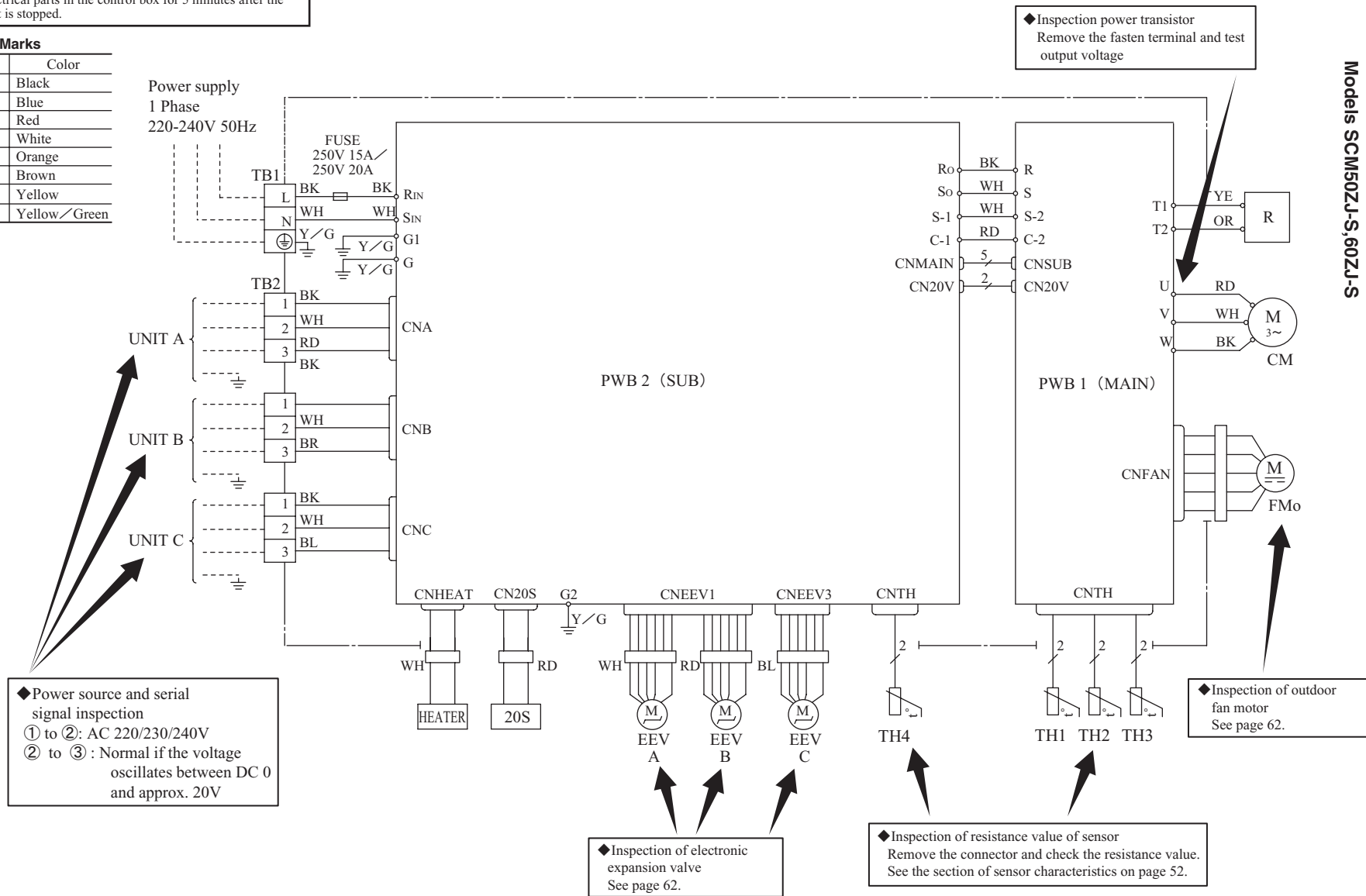

◆ Inspection power transistor  
Remove the fasten terminal and test output voltage

◆ Power source and serial signal inspection  
① to ②: AC 220/230/240V  
② to ③: Normal if the voltage oscillates between DC 0 and approx. 20V

◆ Inspection of electronic expansion valve  
See page 62.

◆ Inspection of resistance value of sensor  
Remove the connector and check the resistance value.  
See the section of sensor characteristics on page 52.

◆ Inspection of outdoor fan motor  
See page 62.

Models SCM50ZJ-S, 60ZJ-S

**⚠ CAUTION- HIGH VOLTAGE**

High voltage is produced in the control box. Don't touch electrical parts in the control box for 5 minutes after the unit is stopped.

Color Marks	
Mark	Color
BK	Black
BL	Blue
BR	Brown
RD	Red
WH	White
OR	Orange
BR	Brown
YE	Yellow
Y/G	Yellow/Green

Power supply  
1 Phase  
220-240V 50Hz

◆ Inspection power transistor  
Remove the fasten terminal and test output voltage

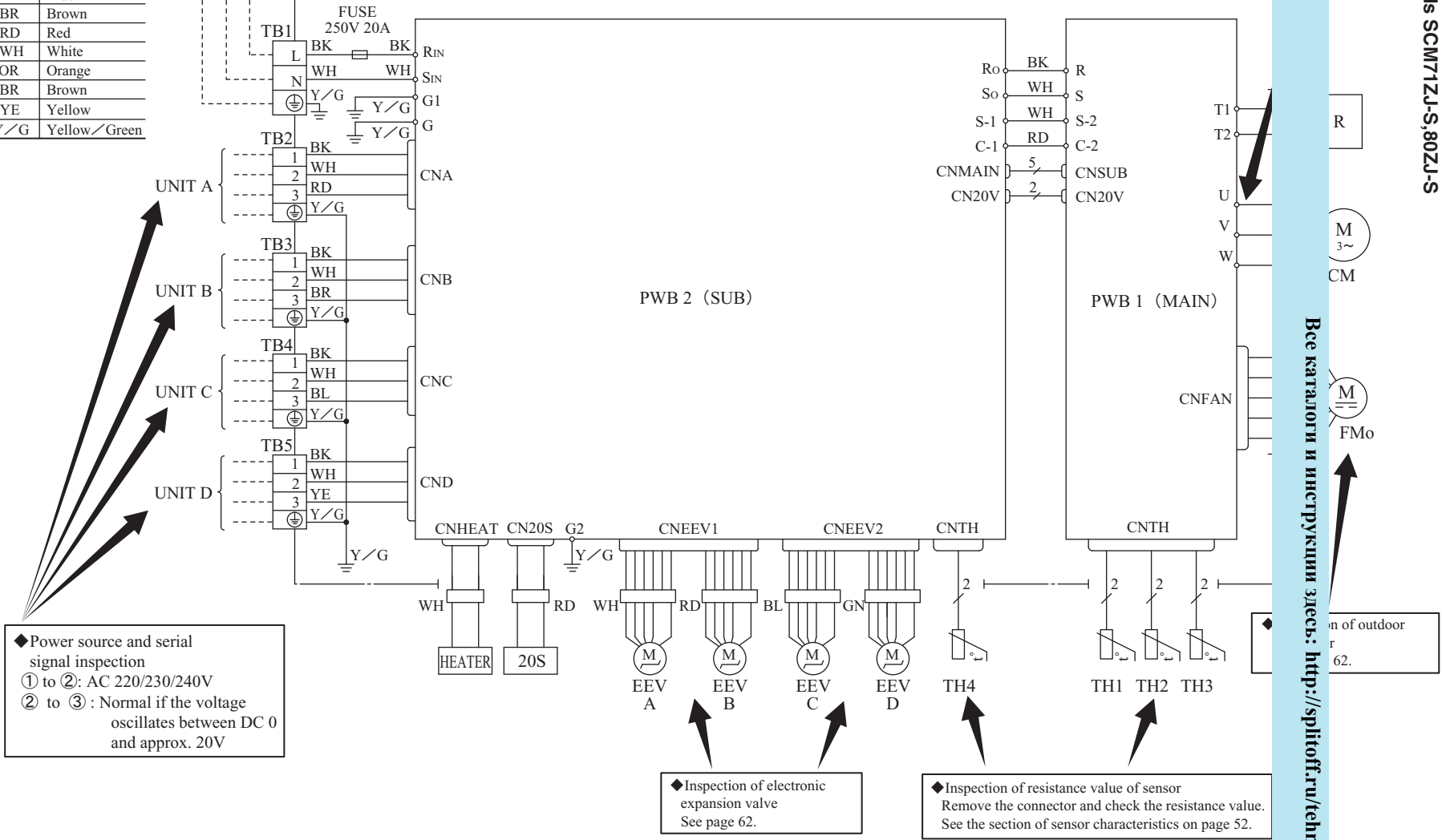

◆ Power source and serial signal inspection  
① to ②: AC 220/230/240V  
② to ③: Normal if the voltage oscillates between DC 0 and approx. 20V

◆ Inspection of electronic expansion valve  
See page 62.

◆ Inspection of resistance value of sensor  
Remove the connector and check the resistance value. See the section of sensor characteristics on page 52.

Все каталоги и инструкции здесь: <http://splitoff.ru/ehb-doc.html>

Models SCM71ZJ-S, 80ZJ-S

**(a) Inspection of electronic expansion valve**

Electronic expansion valve operates for approx. 10 seconds after the power on, in order to determine its aperture. Check the operating sound and voltage during the period of time. (Voltage cannot be checked during operation in which only the aperture change occurs.)

Все каталоги и инструкции здесь: <http://splitoff.ru/tehn-doc.html>

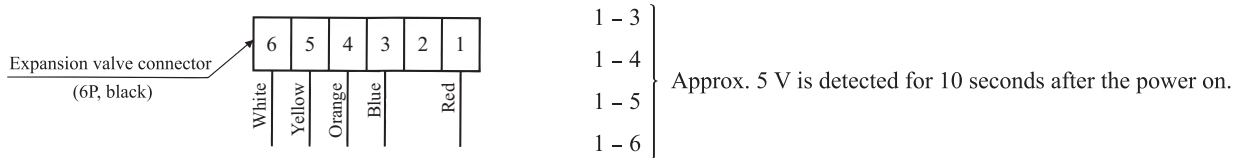

- 3) If voltage is detected, the outdoor sub PCB is normal.
- 4) If the expansion valve does not operate (no operating sound) while voltage is detected, the expansion valve is defective.

**• Inspection of electronic expansion valve as a separate unit**

Measure the resistance between terminals with an analog tester.

Measuring point	Resistance when normal
1-6	46 ± 4Ω (at 20°C)
1-4	
1-3	
1-5	

**(b) Outdoor unit fan motor check procedure**

- When the outdoor unit fan motor error is detected, diagnose which of the outdoor unit fan motor or outdoor main PCB is defective.
- Diagnose this only after confirming that the indoor unit is normal.

(1) Outdoor main PCB output check

- 1) Turn off the power.
- 2) Disconnect the outdoor unit fan motor connector CNFAN.
- 3) When the outdoor unit is operated by inserting the power supply plug and pressing (ON) the backup switch for more than 5 seconds, if the voltage of pin No. ② in the following figure is output for 30 seconds at 20 seconds after turning “ON” the backup switch, the outdoor main PCB is normal but the fan motor is defective.

If the voltage is not detected, the outdoor main PCB is defective but the fan motor is normal.

Note (1) The voltage is output 3 times repeatedly. If it is not detected, the indoor unit displays the error message.

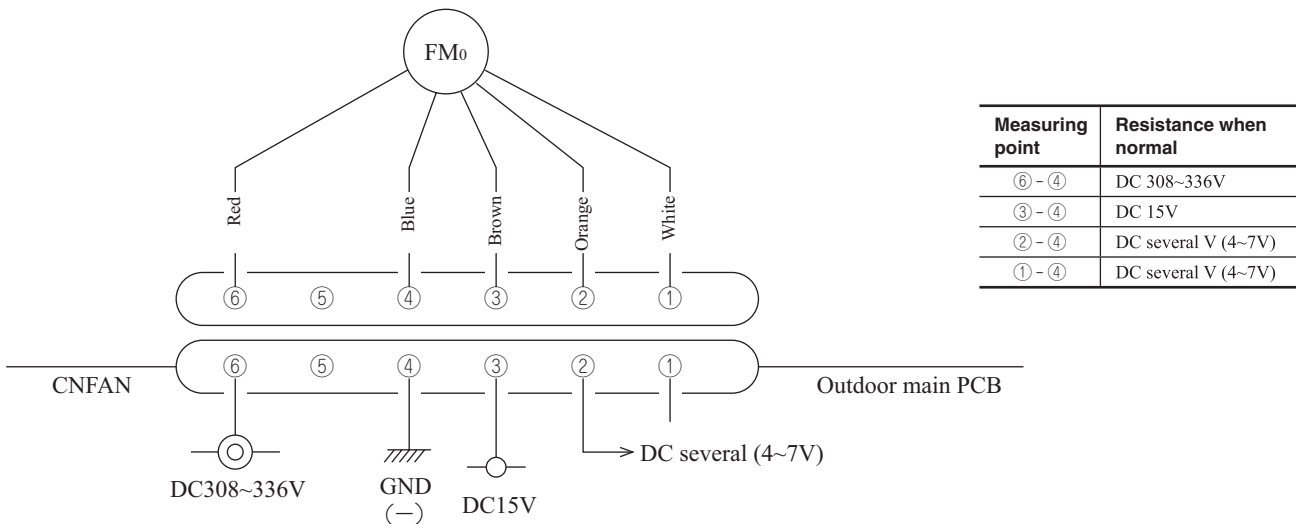

**2) Fan motor resistance check**

Measuring point	Resistance when normal
⑥ - ④ (Red - Black)	20 MΩ or higher
③ - ④ (White - Black)	20 kΩ or higher

- Notes (1) Remove the fan motor and measure it without power connected to it.
- (2) If the measured value is below the value when the motor is normal, it means that the fan motor is faulty.

## 2.2 FDTC series

### 2.2.1 Diagnosing of microcomputer circuit

#### (1) Selfdiagnosis function

##### (a) Check indicator table

Все каталоги и инструкции здесь: <http://splitoff.ru/tehn-doc.html>

roller error code,  
check pilot lamp).

#### (i) Indoor unit

Remote controller		Indoor control PCB		Outdoor main PCB	Location of trouble	Description of trouble	Repair method	Reference page
Error code	Red LED	Red LED	Green LED (1)	Red LED				
No-indication	Stays OFF	Stays OFF	Keeps flashing	Stays OFF	—	• Normal operation	—	—
		Stays OFF	Stays OFF	Stays OFF	Indoor unit power supply	• Power OFF, broken wire/blown fuse, broken transformer wire	Repair	83
		* 3 times flash	Keeps flashing	Stays OFF	Remote controller wires	• Poor connection, breakage of remote controller wire * For wire breaking at power ON, the LED is OFF.	Repair	84
			Remote controller	• Defective remote controller PCB	Replacement of remote controller			
WAIT or INSPECT I/U	Stays OFF	Keeps flashing	Stays OFF	Indoor-outdoor units connection wire	• Poor connection, breakage of indoor-outdoor units connection wire	Repair	85 ~ 89	
				Remote controller	• Improper setting of master and slave by remote controller			
E1	Stays OFF	* Keeps flashing	Stays OFF	Remote controller wires (Noise)	• Poor connection of remote controller signal wire (White) * For wire breaking at power ON, the LED is OFF	Repair	90	
				Remote controller indoor control PCB	* Defective remote controller or indoor control PCB (defective communication circuit)?			Replacement of remote controller or PCB
E5	2 times flash	Keeps flashing	6 times flash	Indoor-outdoor units connection wire	• Poor connection of wire between indoor-outdoor units during operation (disconnection, loose connection)	Repair	91	
				(Noise)	• CPU-runaway on outdoor control PCB			
				Outdoor control PCB	* Occurrence of defective outdoor control PCB on the way of power supply (defective communication circuit)?	Replacement of PCB		
				Fuse	• Blown fuse	Replacement		
E6	1 time flash	Keeps flashing	Stays OFF	Indoor heat exchanger temperature thermistor	• Defective indoor heat exchanger temperature thermistor (defective element, broken wire, short-circuit)	Replacement, repair of temperature thermistor	92	
				Indoor control PCB	* Defective indoor control PCB (Defective temperature thermistor input circuit)?			Replacement of PCB
E7	1 time flash	Keeps flashing	Stays OFF	Indoor return air temperature thermistor	• Defective indoor return air temperature thermistor (defective element, broken wire, short-circuit)	Replacement, repair of temperature thermistor	93	
				Indoor control PCB	* Defective indoor control PCB (Defective temperature thermistor input circuit)?			Replacement of PCB
E8	1 time flash	Keeps flashing	Stays OFF	Installation or operating condition	• Heating over-load (Anomalously high indoor heat exchanger temperature)	Repair	94	
				Indoor heat exchanger temperature thermistor	• Defective indoor heat exchanger temperature thermistor (short-circuit)			
				Indoor control PCB	* Defective indoor control PCB (Defective temperature thermistor input circuit)?	Replacement of PCB		
E9	1 time flash	Keeps flashing	Stays OFF	Drain trouble	• Defective drain pump (DM), broken drain pump wire, disconnected connector	Replacement, repair of DM	95	
				Float switch	• Anomalous float switch operation (malfunction)			
				Indoor control PCB	* Defective indoor control PCB (Defective float switch input circuit)	Replacement of PCB		
				Option	* Defective optional parts (At optional anomalous input setting)			
E10	Stays OFF	Keeps flashing	Stays OFF	Number of connected indoor units	• When multi-unit control by remote controller is performed, the number of units is over	Repair	96	
E16	Stays OFF	Keeps flashing	Stays OFF	Fan motor	• Defective fan motor	Replacement, repair	97	
				Indoor control PCB	• Defective indoor control PCB			Replacement
E19	1 time flash	Keeps flashing	Stays OFF	Indoor control PCB	• Improper operation mode setting	Repair	98	
E28	Stays OFF	Keeps flashing	Stays OFF	Remote controller temperature thermistor	• Broken wire of remote controller temperature thermistor	Repair	99	

Note (1) Normal indicator lamp (Indoor unit: Green) extinguishes (or lights continuously) only when CPU is anomalous. It keeps flashing in any trouble other than anomalous CPU.

(2) \* mark in the Description of trouble means that, in ordinary diagnosis, it cannot identify the cause definitely, and, if the trouble is repaired by replacing the part, it is judged consequently that the replaced part was defective.

## (ii) Outdoor unit

Remote controller		Indoor control PCB		Outdoor main PCB	Location of trouble	Description of trouble	Repair method	Reference page
Error code	Red LED	Red LED	Green LED	Red LED				
<b>Все каталоги и инструкции здесь: <a href="http://splitoff.ru/tehn-doc.html">http://splitoff.ru/tehn-doc.html</a></b>								
E33		Stays OFF	flashing	flash	temperature sensor		Repair	100
					Outdoor main PCB	* Defective outdoor main PCB (Defective temperature sensor input circuit)?	Replacement, repair of temperature sensor	
E36		Stays OFF	Keeps flashing	5 times flash	Installation, operation status	• Higher discharge temperature	Repair	101
					Discharge pipe temperature sensor	• Defective discharge pipe temperature sensor	Replacement, repair of temperature sensor	
					Outdoor main PCB	* Defective outdoor main PCB (Defective temperature sensor input circuit)?	Replacement of PCB	
E37		Stays OFF	Keeps flashing	8 times flash	Outdoor heat exchanger temperature sensor	• Defective outdoor heat exchanger temperature sensor, broken wire or poor connector connection	Replacement, repair of temperature sensor	102
					Outdoor main PCB	* Defective outdoor main PCB (Defective temperature sensor input circuit)?	Replacement of PCB	
E38		Stays OFF	Keeps flashing	8 times flash	Outdoor air temperature sensor	• Defective outdoor air temperature sensor, broken wire or poor connector connection	Replacement, repair of temperature sensor	103
					Outdoor main PCB	* Defective outdoor main PCB (Defective temperature sensor input circuit)?	Replacement of PCB	
E39		Stays OFF	Keeps flashing	8 times flash	Discharge pipe temperature sensor	• Defective discharge pipe temperature sensor, broken wire or poor connector connection	Replacement, repair of temperature sensor	104
					Outdoor main PCB	* Defective outdoor main PCB (Defective temperature sensor input circuit)?	Replacement of PCB	
E42		Stays OFF	Keeps flashing	1 time flash	Outdoor main PCB, compressor	• Current cut (Anomalous compressor over-current)	Replacement of PCB	105 • 106
					Installation, operation status	• Service valve closing operation	Repair	
E45		Stay OFF	Keeps flashing	4 times flash	Outdoor main PCB	• Anomalous outdoor main PCB communication	Replacement of PCB	107
					Outdoor sub PCB	• Anomalous outdoor sub PCB communication		
E47		Stays OFF	Keeps flashing	2 times flash	Outdoor sub PCB	• Defective active filter	Repair PCB replacement	108
E48		Stays OFF	Keeps flashing	Keeps flashing	Fan motor	• Defective fan motor	Replacement	109
					Outdoor main PCB	• Defective outdoor main PCB		
E51		Stays OFF	Keeps flashing	1 time flash	Power transistor error (outdoor main PCB)	• Power transistor error	Replacement of PCB	110
E53		Stays OFF	Keeps flashing	8 times flash	Outdoor suction pipe sensor	• Defective suction pipe temperature sensor, broken wire or poor connector connection	Replacement, repair of temperature sensor	111
					Outdoor sub PCB	• Defective outdoor sub PCB (Defective temperature sensor input circuit)?	Replacement of PCB	
E57		Stays OFF	Keeps flashing	2 times flash	Operation status	• Shortage in refrigerant quantity	Repair	112
					Installation status	• Service valve closing operation	Service valve opening check	
E58		Stays OFF	Keeps flashing	3 times flash	• Overload operation • Overcharge • Compressor locking	• Current safe stop	Replacement	113
E59		Stays OFF	Keeps flashing	2 times flash	Compressor, outdoor main PCB	• Anomalous compressor startup	Replacement	114
E60		Stays OFF	Keeps flashing	7 times flash	Compressor	• Anomalous compressor rotor lock	Replacement	115

Note (1) \* mark in the Description of trouble means that, in ordinary diagnosis, it cannot identify the cause definitely, and, if the trouble is repaired by replacing the part, it is judged consequently that the replaced part was defective.

(iv) Display sequence of error codes or inspection indicator lamps

■ Occurrence of one kind of error

Displays are shown respectively according to errors.

■ Occurrence of plural kinds of error

Все каталоги и инструкции здесь: <http://splitoff.ru/tehn-doc.html>

controller	• Displays the error of higher priority (When plural errors are persisting)
Red LED on indoor control PCB	<i>E1 E5 ..... E10 &gt; E35 &gt; ..... E60</i>
Red LED on outdoor main PCB	• Displays the present errors. (When a new error has occurred after the former error was reset.)

■ Error detecting timing

Section	Error description	Error code	Error detecting timing
Indoor	Drain trouble (Float switch activated)	<i>E9</i>	Whenever float switch is activated after 30 second had past since power ON.
	Communication error at initial operation	“ <i>WAIT</i> ”	No communication between indoor and outdoor units is established at initial operation.
	Remote controller communication circuit error	<i>E1</i>	Communication between indoor unit and remote controller is interrupted for mote than 2 minutes continuously after initial communication was established.
	Communication error during operation	<i>E5</i>	Communication between indoor and outdoor units is interrupted for mote than 2 minutes continuously after initial communication was established.
	Excessive number of connected indoor units by controlling with one remote controller	<i>E10</i>	Whenever excessively connected indoor units is detected after power ON.
	Return air temperature thermistor anomaly	<i>E7</i>	-50°C or lower is detected for 5 seconds continuously within 60 minutes after initial detection of this anomalous temperature.
	Indoor heat exchanger temperature thermistor anomaly	<i>E6</i>	-50°C or lower is detected for 5 seconds continuously within 60 minutes after initial detection of this anomalous temperature. Or 70°C or higher is detected for 5 seconds continuously.
Outdoor	Outdoor air temperature sensor anomaly	<i>E38</i>	-55°C or lower is detected for 5 seconds continuously 3 times within 40 minutes after initial detection of this anomalous sensor. Or -55°C or higher is detected for 5 seconds continuously within 20 seconds after power ON.
	Outdoor heat exchanger temperature sensor anomaly	<i>E37</i>	-55°C or lower is detected for 5 seconds continuously 3 times within 40 minutes after initial detection of this anomalous sensor. Or -55°C or lower is detected for 5 seconds continuously within 20 seconds after power ON.
	Discharge pipe temperature sensor anomaly	<i>E39</i>	-25°C or lower is detected for 5 seconds continuously 3 times within 40 minutes after initial detection of this anomalous sensor.
	Suction pipe temperature sensor anomaly	<i>E53</i>	-55°C or lower is detected for 5 seconds continuously 3 times within 40 minutes after initial detection of this anomalous sensor. Or -55°C or higher is detected for 5 seconds continuously within 20 seconds after power ON.



■ **Error log and reset**

Error indicator	Memorized error log	Reset
Remote controller display	• Higher priority error is memorized.	• Stop the unit by pressing the ON/OFF switch of remote controller.
Red LED on indoor control PCB	• Not memorized	

Все каталоги и инструкции здесь: <http://splitoff.ru/tehn-doc.html>

■ **Resetting the error log**

- Resetting the memorized error log in the remote controller  
Holding down “CHECK” button, press “TIMER” button to reset the error log memorized in the remote controller.
- Resetting the memorized error log  
The remote controller transmits error log erase command to the indoor unit when “VENTI” button is pressed while holding down “CHECK” button.  
Receiving the command, the indoor unit erase the log and answer the status of no error.

(2) **Troubleshooting procedure**

When any trouble has occurred, inspect as follows. Details of respective inspection method will be described on later pages.

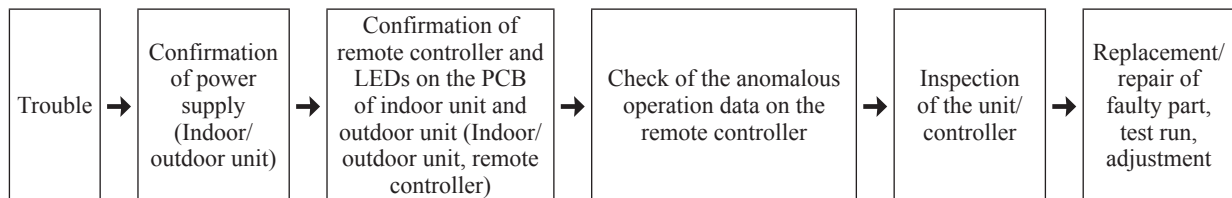

(3) **Troubleshooting at the indoor unit**

With the troubleshooting, find out any defective part by checking the voltage (AC, DC), resistance, etc. at respective connectors at around the indoor PCB, according to the inspection display or operation status of unit (the compressor does not run, fan does not run, the 4-way valve does not switch, etc.), and replace or repair in the unit of following part.

(a) **Replacement part related to indoor PCB's**

Control PCB, power supply PCB, temperature thermistor (return air, indoor heat exchanger), remote controller switch and fuse

Note (1) With regard to parts of high voltage circuits and refrigeration cycle, judge it according to ordinary inspection methods.

(b) **Instruction of how to replace indoor control PCB**

**SAFETY PRECAUTIONS**

- Read the "SAFETY PRECAUTIONS" carefully first of all and then strictly follow it during the replacement in order to protect yourself.
- The precautionary items mentioned below are distinguished into two levels, WARNING and CAUTION. Both mentions the important items to protect your health and safety so strictly follow them by any means.

⚠ **WARNING** Wrong installation would cause serious consequences such as injuries or death.

⚠ **CAUTION** Wrong installation might cause serious consequences depending on circumstances.

- After completing the replacement, do commissioning to confirm there are no anomaly.

**WARNING**

- Replacement should be performed by the specialist.  
If you replace the PCB by yourself, it may lead to serious trouble such as electric shock or fire.
- Replace the PCB correctly according to these instructions.  
Improper replacement may cause electric shock or fire.
- Shut off the power before electrical wiring work.  
Replacement during the applying the current would cause the electric shock, unit failure or improper running.  
It would cause the damage of connected equipment such as fan motor, etc.
- Fasten the wiring to the terminal securely, and hold the cable securely so as not to apply unexpected stress on the terminal.  
Loose connections or hold could result in abnormal heat generation or fire.
- Check the connection of wiring to PCB correctly before turning on the power, after replacement.  
Defectiveness of replacement may cause electric shock or fire.

**CAUTION**

- In connecting connector onto the PCB, connect not to deform the PCB. It may cause breakage or malfunction.
- Insert connector securely, and hook stopper. It may cause fire or improper running.
- Bundle the cables together so as not to be pinched or be tensioned. It may cause malfunction or electric shock for disconnection or deformation.

• Control PCB

Replace and set up the PCB according to this instruction.

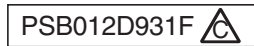

① Set to an appropriate address and function using switch on PCB.

Все каталоги и инструкции здесь: <http://splitoff.ru/tehn-doc.html>

Address	SW2	Plural indoor units control by 1 remote controller	
Test run	SW7-1	—	Normal
		○	Operation check/drain motor test run

○:ON —:OFF

② Set to an appropriate capacity using the model selector switch(SW6).

Select the same capacity with the PCB removed from the unit.

SW6	-1	-2	-3	-4
25VD	○	—	—	—
35VD	—	○	—	—
50VD	○	—	○	—
60VD	○	○	○	—

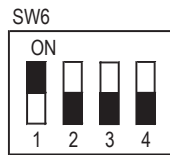

Example setting fro 25VD

③ Replace the PCB

1. Fix the PCB so as not to pitch the cords.
2. Connect connectors to the PCB. Connect a cable connector with the PCB connector of the same color.
3. Do not pass CPU surrounding about wirings.

④ Control PCB

Parts mounting are different by the kind of PCB.

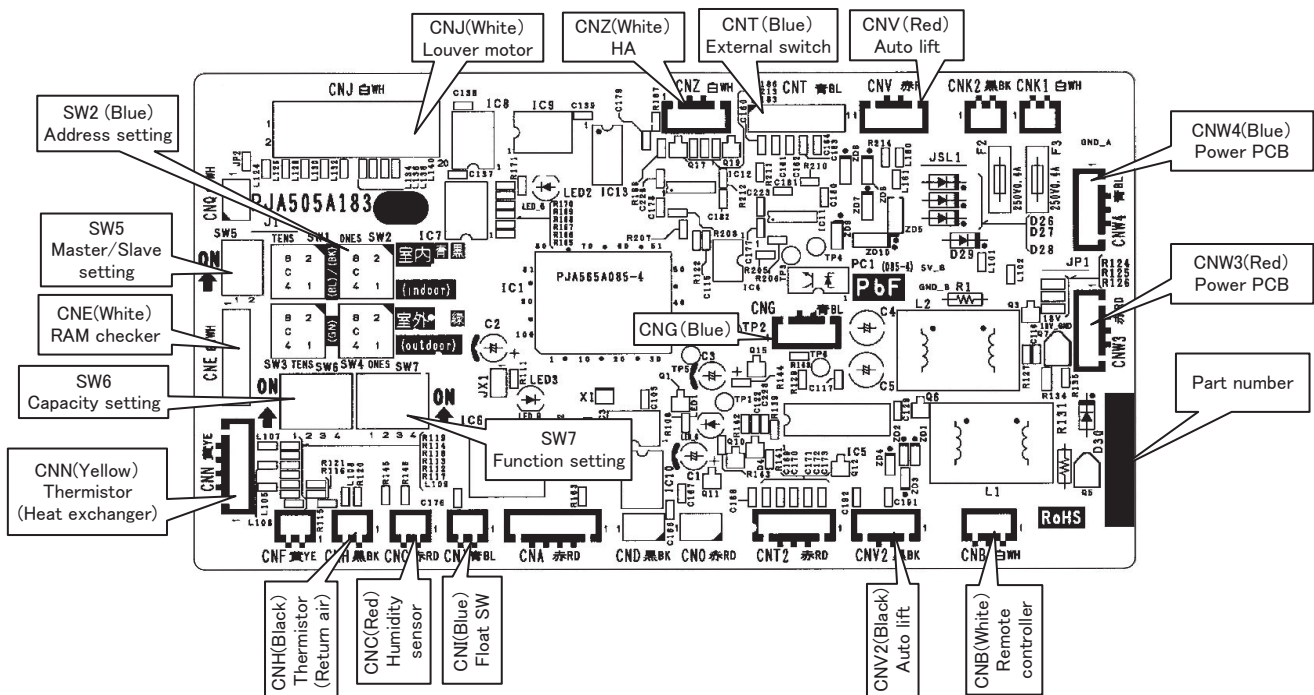

• Power PCB

PSB012D953A

This PCB is a general PCB. Replace the PCB according to this instruction.

① Replace the PCB (refer to right dwg.)

1. Unscrew terminal of the wiring(yellow/green) soldered to PCB from the box.

Все каталоги и инструкции здесь: <http://splitoff.ru/tehn-doc.html>

te 1)

4. Fix the board such that it will not pinch any of the wires.
5. Reconnect the wirings to the PCB. Wiring connector color should match with the color of connector of the PCB. (Note 2)
6. Let the wiring (red and blue) pass beneath the (yellow/green) wiring and bind together with band.
7. Screw back the terminal of wiring (yellow/green) from PCB(T1, T2/T3), that was removed in 1.

In that case, do not place the crimping part of the wiring under the PCB.

(Note 1): It might not be applicable on some models.

(Note 2): After replacing PCB, connection between capacitor assy and connector CNP is **no longer needed.**

② Power PCB

Parts mounting are different by the kind of PCB.

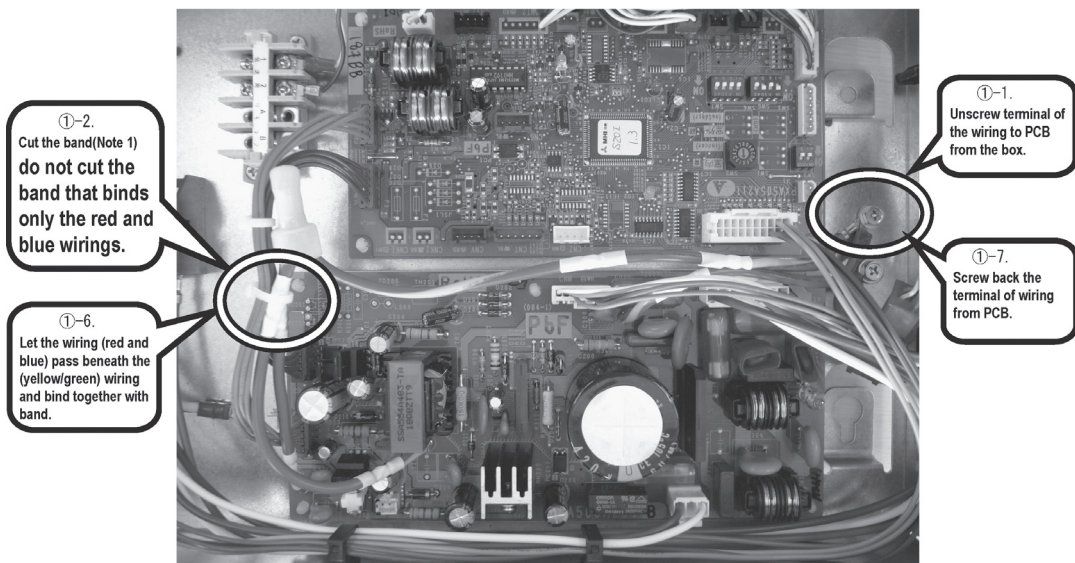
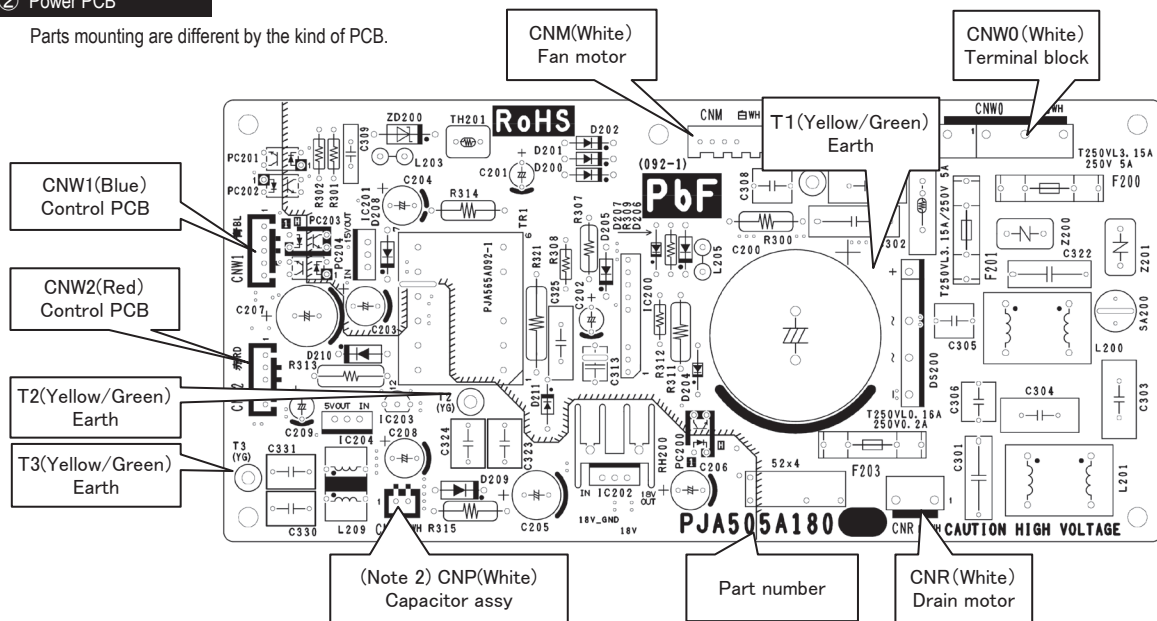

●DIP switch setting list

Switches	Description	Default setting	Remarks
----------	-------------	-----------------	---------

Все каталоги и инструкции здесь: <http://splitoff.ru/tehn-doc.html>

SW6-3	Model selection	As per model	See table 1
SW6-4			
SW7-1	Test run, Drain motor	Normal*/Test run	OFF Normal
SW7-2	Reserved		OFF keep OFF
SW7-3	Powerful mode	Valid*/Invalid	ON Valid
SW7-4	Reserved		OFF keep OFF
JSL1	Superlink terminal spare	Normal*/switch to spare	With

\* Default setting

Table 1: Indoor unit model selection with SW6-1-SW6-4

	0: OFF 1:ON			
	25VD	35VD	50VD	60VD
SW6-1	1	0	1	1
SW6-2	0	1	0	1
SW6-3	0	0	1	1
SW6-4	0	0	0	0

**(4) Check of anomalous operation data with the remote controller**

Operation data can be checked with remote control unit operation.

① Press the **CHECK** button.

Все каталоги и инструкции здесь: <http://splitoff.ru/tehn-doc.html>

② Press the **SET** button while the LED light is displayed.

③ When only one indoor unit is connected to remote controller, “DATA LOADING” is displayed (blinking indication during data loading).

Next, operation data of the indoor unit will be displayed. Skip to step ⑦.

④ When plural indoor units is connected, the smallest address number of indoor unit among all connected indoor unit is displayed.

[Example]:

“SELECT I/U” (blinking 1 seconds) → “I/U000” blinking.

⑤ Select the indoor unit number you would like to have data displayed with the **▲ ▼** button.

⑥ Determine the indoor unit number with the **SET** button. (The indoor unit number changes from blinking indication to continuous indication)

“I/U000” (The address of selected indoor unit is blinking for 2 seconds.)



“DATA LOADING” (A blinking indication appears while data loaded.)

Next, the operation data of the indoor unit is indicated.

⑦ Upon operation of the **▲ ▼** button, the current operation data is displayed in order from data number 01.

The items displayed are in the above table.

\*Depending on models, the items that do not have corresponding data are not displayed.

⑧ To display the data of a different indoor unit, press the **AIR CON NO.** button, which allows you to go back to the indoor unit selection screen.

⑨ Pressing the **ON/OFF** button will stop displaying data.

Pressing the **RESET** button during remote control unit operation will undo your last operation and allow you to go back to the previous screen.

⓪ If two (2) remote controllers are connected to one (1) inside unit, only the master controller is available for trial operation and confirmation of operation data. (The slave remote controller is not available.)

Number	Data Item
01	☼ (Operation Mode)
02	SET TEMP $\text{°C}$ (Set Temperature)
03	RETURN AIR $\text{°C}$ (Return Air Temperature)
04	INDOOR AIR $\text{°C}$ (Indoor Air Temperature)
05	INDOOR HEAT EXCHANGER THERMISTOR TEMPERATURE (Indoor Heat Exchanger Thermistor / U Bend)
06	THI-R2 $\text{°C}$ (Indoor Heat Exchanger Thermistor /Capillary)
07	THI-R3 $\text{°C}$ (Indoor Heat Exchanger Thermistor /Gas Header)
08	I/U FANSPEED $\text{Hz}$ (Indoor Unit Fan Speed)
09	DEMAND $\text{Hz}$ (Frequency Requirements)
10	ANSWER $\text{Hz}$ (Response Frequency)
11	I/U EEV $\text{P}$ (Pulse of Indoor Unit Expansion Value)
12	TOTAL I/U RUN $\text{H}$ (Total Running Hours of The Indoor Unit)
21	OUTDOOR $\text{°C}$ (Outdoor Air Temperature)
22	THO-R1 $\text{°C}$ (Outdoor Heat Exchanger Thermistor)
23	THO-R2 $\text{°C}$ (Outdoor Heat Exchanger Thermistor)
24	COMP $\text{Hz}$ (Compressor Frequency)
25	HP $\text{MPa}$ (High Pressure)
26	LP $\text{MPa}$ (Low Pressure)
27	Td $\text{°C}$ (Discharge Pipe Temperature)
28	COMP BOTTOM $\text{°C}$ (Comp Bottom Temperature)
29	CT $\text{AMP}$ (Current)
30	TARGET SH $\text{°C}$ (Target Super Heat)
31	SH $\text{°C}$ (Super Heat)
32	TDSH $\text{°C}$ (Discharge Pipe Super Heat)
33	PROTECTION No. (Protection State No. of The Compressor)
34	O/U FANSPEED $\text{Hz}$ (Outdoor Unit Fan Speed)
35	63H1 (63H1 On/Off)
36	DEFROST (Defrost Control On/Off)
37	TOTAL COMP RUN $\text{H}$ (Total Running Hours of The Compressor)
38	O/U EEV1 $\text{P}$ (Pulse of The Outdoor Unit Expansion Valve EEVC)
39	O/U EEV2 $\text{P}$ (Pulse of The Outdoor Unit Expansion Valve EEVH)

**(5) Inverter checker for diagnosis of inverter output**

● Checking method

(a) Setup procedure of checker.

- 1) Power OFF (Turn off the breaker).
- 2) Remove the terminal cover of compressor and disconnect the wires (U, V, W) from compressor.

Все каталоги и инструкции здесь: <http://splitoff.ru/tehn-doc.html>

and wires (U, V, W)

(b) Operation for judgment.

- 1) Power ON and start check operation on cooling or heating mode.
- 2) Check ON/OFF status of 6 LED's on the checker.
- 3) Judge the PCB by ON/OFF status of 6 LED's on the checker.

ON/OFF status of LED	If all of LED are ON/OFF according to following pattern	If all of LED stay OFF or some of LED are ON/OFF
Outdoor main PCB	Normal	Anomalous

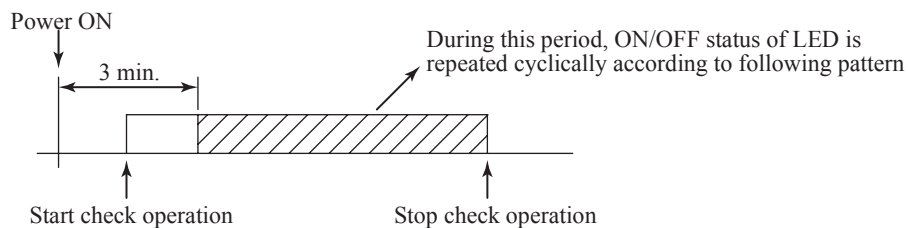

- 4) Stop check operation within about 2minutes after starting check operation.

〈Inverter Checker〉

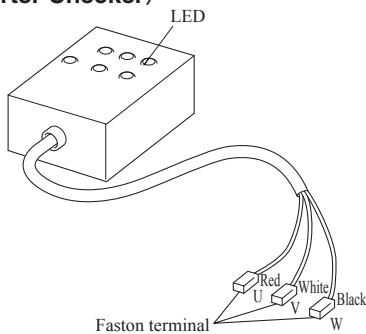

LED ON/OFF pattern

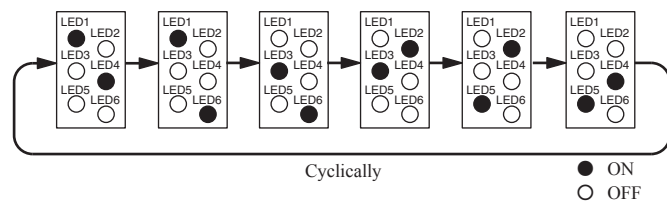

Connect to the terminal of the wires which are disconnected from compressor.

### ⚠ CAUTION- HIGH VOLTAGE

High voltage is produced in the control box. Don't touch electrical parts in the control box for 5 minutes after the unit is stopped.

#### Color Marks

Mark	Color
BK	Black
RD	Red
WH	White
OR	Orange
BR	Brown
YE	Yellow
Y/G	Yellow/Green

Power supply  
1 Phase  
220-240V 50Hz

◆ **Inspection power transistor**  
Remove the fasten terminal and test output voltage

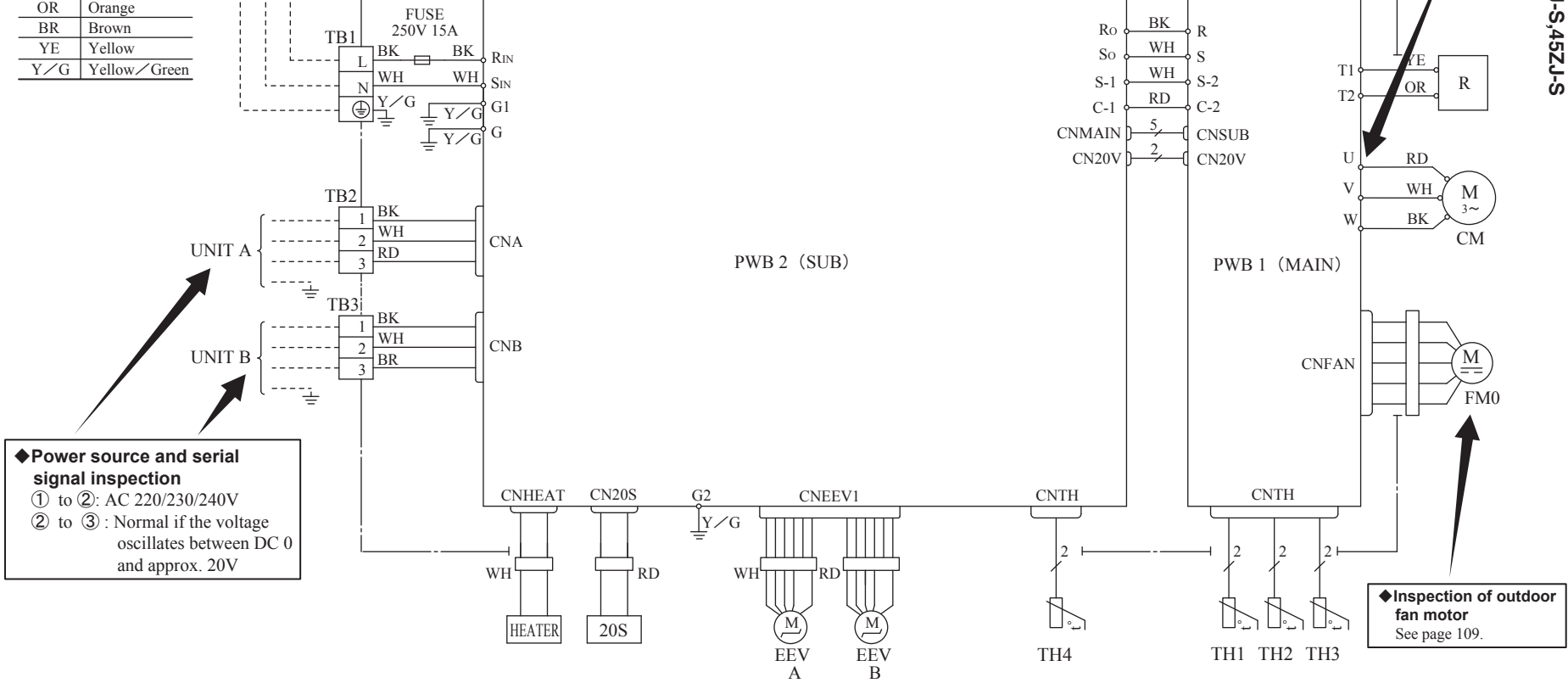

◆ **Power source and serial signal inspection**  
① to ②: AC 220/230/240V  
② to ③: Normal if the voltage oscillates between DC 0 and approx. 20V

◆ **Inspection of outdoor fan motor**  
See page 109.

(6) Outdoor unit inspection points  
Models SCM40ZJ-S,45ZJ-S

**⚠ CAUTION- HIGH VOLTAGE**

High voltage is produced in the control box. Don't touch electrical parts in the control box for 5 minutes after the unit is stopped.

**Color Marks**

Mark	Color
BK	Black
BL	Blue
RD	Red
WH	White
OR	Orange
BR	Brown
YE	Yellow
Y/G	Yellow/Green

Power supply  
1 Phase  
220-240V 50Hz

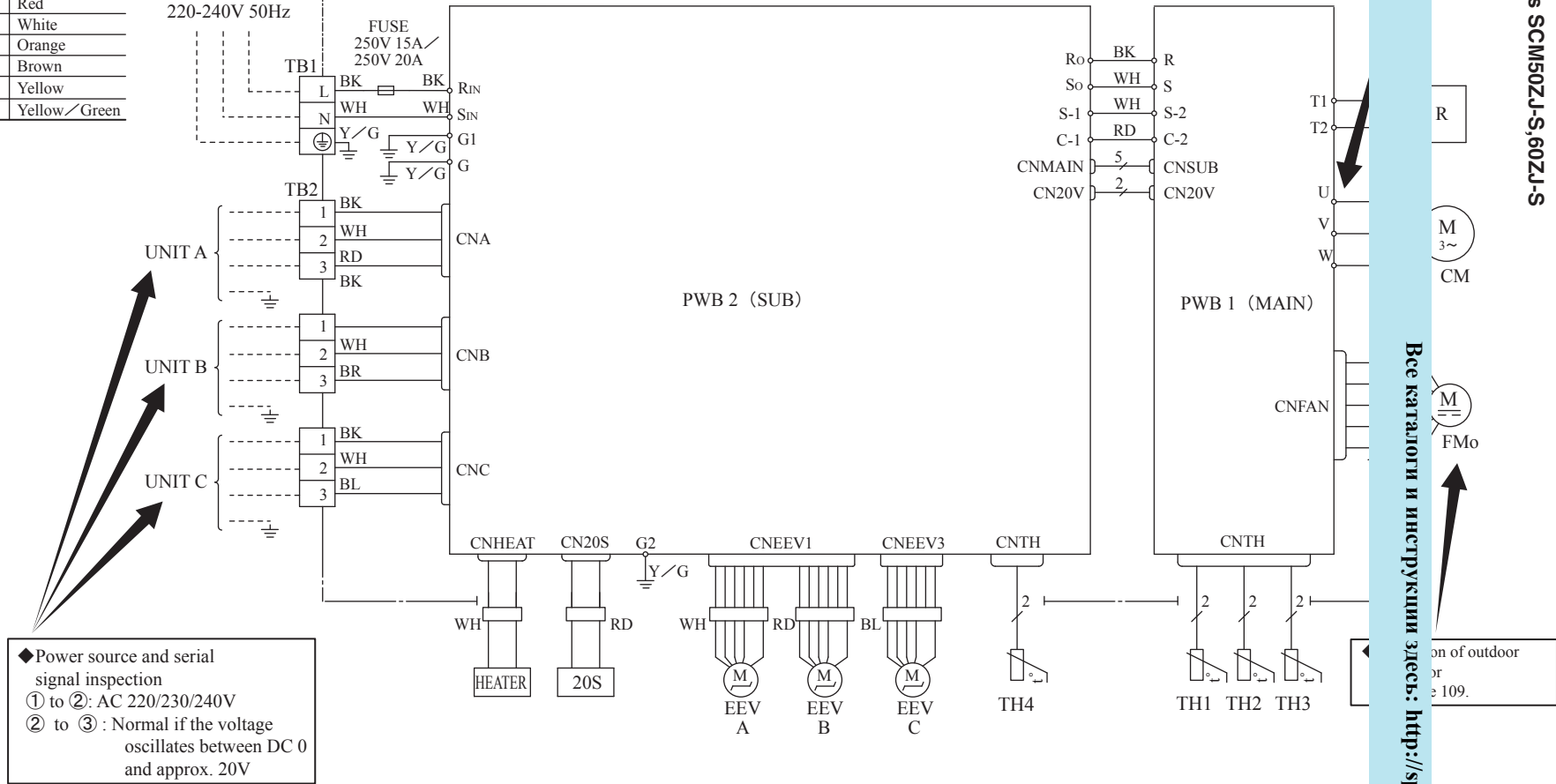

◆ Inspection power transistor  
Remove the fasten terminal and test output voltage

◆ Power source and serial signal inspection  
① to ②: AC 220/230/240V  
② to ③: Normal if the voltage oscillates between DC 0 and approx. 20V

Всё каталоги и инструкции здесь: <http://splitoff.ru/ehh-doc.html>

Models SCM50ZJ-S, 60ZJ-S



### ⚠ CAUTION- HIGH VOLTAGE

High voltage is produced in the control box. Don't touch electrical parts in the control box for 5 minutes after the unit is stopped.

#### Color Marks

Mark	Color
BK	Black
BL	Blue
BR	Brown
RD	Red
WH	White
OR	Orange
BR	Brown
YE	Yellow
Y/G	Yellow/Green

Power supply  
1 Phase  
220-240V 50Hz

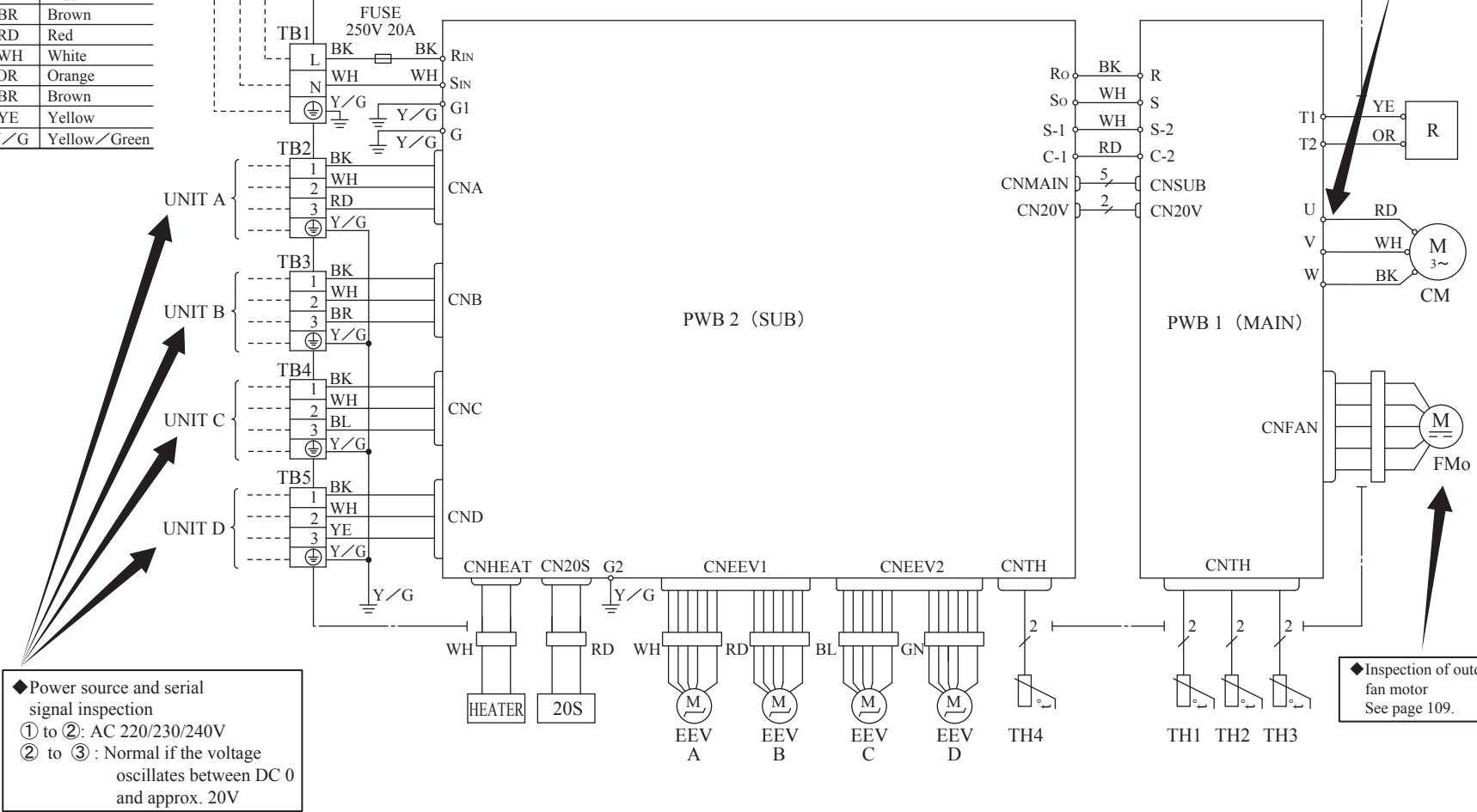

◆ Inspection power transistor  
Remove the fasten terminal and test output voltage

◆ Inspection of outdoor fan motor  
See page 109.

◆ Power source and serial signal inspection  
① to ②: AC 220/230/240V  
② to ③: Normal if the voltage oscillates between DC 0 and approx. 20V

Models SCM71ZJ-S, 80ZJ-S

## 2.2.2 Troubleshooting flow

### (1) List of troubles

No.	Remote controller display	Description of trouble	Reference page
1	None	Operates but does not cool.	76
2	None	Operates but does not heat.	77
3	None	Earth leakage breaker activated	78
4	None	Excessive noise/vibration (1/3)	79
5	None	Excessive noise/vibration (2/3)	80
6	None	Excessive noise/vibration (3/3)	81
7	None	Louver motor failure	82
8	None	Power supply system error (Power supply to indoor control PCB)	83
9	None	Power supply system error (Power supply to remote controller)	84
10	INSPECT I/U	INSPECT I/U (When 1 or 2 remote controllers are connected)	85
11	INSPECT I/U	INSPECT I/U (Connection of 3 units or more remote controllers)	86
12	🔊WAIT🔊	Communication error at initial operation	87~89
13	E1	Remote controller communication circuit error	90
14	E5	Communication error during operation	91
15	E6	Indoor heat exchanger temperature thermistor anomaly	92
16	E7	Return air temperature thermistor anomaly	93
17	E8	Heating overload operation	94
18	E9	Drain trouble	95
19	E10	Excessive number of connected indoor units (more than 17 units) by controlling with one remote controller	96
20	E16	Indoor fan motor anomaly	97
21	E19	Indoor unit operation check, drain motor check setting error	98
22	E28	Remote controller temperature thermistor anomaly	99
23	E35	Cooling overload operation	100
24	E36	Discharge pipe temperature error	101
25	E37	Outdoor heat exchanger temperature sensor anomaly	102
26	E38	Outdoor air temperature sensor anomaly	103
27	E39	Discharge pipe temperature sensor anomaly	104
28	E42	Current cut	105, 106
29	E45	Outdoor sub PCB communication error	107
30	E47	Active filter voltage error	108
31	E48	Outdoor fan motor anomaly	109
32	E51	Power transistor anomaly	110
33	E53	Suction pipe temperature error	111
34	E57	Insufficient refrigerant amount or detection of service valve closure	112
35	E58	Current safe stop	113
36	E59	Compressor startup failure	114
37	E60	Anomalous compressor rotor lock	115

(2) Troubleshooting

Error code Remote controller: None	LED	Green	Red	Content <b>Operates but does not cool</b>
	Indoor	Keeps flashing	Stays OFF	
	Outdoor	—	Stays OFF	

<p>1. Applicable model</p> <p>All models</p>	<p>5. Troubleshooting</p> <table border="1" style="width: 100%;"> <thead> <tr> <th style="width: 60%;">Diagnosis</th> <th style="width: 40%;">Countermeasure</th> </tr> </thead> <tbody> <tr> <td style="vertical-align: top;"> <p>Check the indoor unit fan operation. Check the temperature difference between return and supply air.</p> <p>Is the temperature difference between return and supply air 10-20degC at cooling?</p> <p>NO</p> <p>Is the compressor operating?</p> <p>NO</p> <p>Is the compressor rotation speed low?</p> <p>NO</p> <p>Check which control "Determination control of compressor rotation speed" or "Protective control by controlling compressor rotation speed" is appropriate to this phenomenon.</p> <p>Are the temperature conditions of room and outdoor air close to the rated conditions? (1)</p> <p>NO</p> <p>The unit is operating normally but is operating under the control for protecting compressor or other respective parts.</p> </td> <td style="vertical-align: top;"> <p>It is normal. (This unit is designed to start in the soft start mode by detecting the under dome temperature of compressor when it restart after power reset.)</p> <p>It is necessary to replace to higher capacity one or to install additional unit.</p> <p>Compressor refrigerant oil protection control at starting is activated.</p> <p>Compressor may be stopped by the error detection control. For the contents of control, refer to anomalous stop control by controlling compressor rotation speed of microcomputer control functions.</p> <p>Inspect the followings.</p> <ul style="list-style-type: none"> <li>• Minor clogging of filter</li> <li>• Minor clogging of heat exchanger</li> <li>• Minor short-circuit</li> <li>• Minor shortage of refrigerant amount</li> <li>• Poor compression of compressor</li> </ul> <p>Considering appropriate operation control, check suspicious points. Inspect the followings for reference.</p> <ul style="list-style-type: none"> <li>• Major clogging of filter</li> <li>• Major clogging of heat exchanger</li> <li>• Major short-circuit</li> <li>• Major shortage of refrigerant amount</li> <li>• Compressor protection ON</li> <li>• Indoor fan tap</li> </ul> </td> </tr> </tbody> </table>	Diagnosis	Countermeasure	<p>Check the indoor unit fan operation. Check the temperature difference between return and supply air.</p> <p>Is the temperature difference between return and supply air 10-20degC at cooling?</p> <p>NO</p> <p>Is the compressor operating?</p> <p>NO</p> <p>Is the compressor rotation speed low?</p> <p>NO</p> <p>Check which control "Determination control of compressor rotation speed" or "Protective control by controlling compressor rotation speed" is appropriate to this phenomenon.</p> <p>Are the temperature conditions of room and outdoor air close to the rated conditions? (1)</p> <p>NO</p> <p>The unit is operating normally but is operating under the control for protecting compressor or other respective parts.</p>	<p>It is normal. (This unit is designed to start in the soft start mode by detecting the under dome temperature of compressor when it restart after power reset.)</p> <p>It is necessary to replace to higher capacity one or to install additional unit.</p> <p>Compressor refrigerant oil protection control at starting is activated.</p> <p>Compressor may be stopped by the error detection control. For the contents of control, refer to anomalous stop control by controlling compressor rotation speed of microcomputer control functions.</p> <p>Inspect the followings.</p> <ul style="list-style-type: none"> <li>• Minor clogging of filter</li> <li>• Minor clogging of heat exchanger</li> <li>• Minor short-circuit</li> <li>• Minor shortage of refrigerant amount</li> <li>• Poor compression of compressor</li> </ul> <p>Considering appropriate operation control, check suspicious points. Inspect the followings for reference.</p> <ul style="list-style-type: none"> <li>• Major clogging of filter</li> <li>• Major clogging of heat exchanger</li> <li>• Major short-circuit</li> <li>• Major shortage of refrigerant amount</li> <li>• Compressor protection ON</li> <li>• Indoor fan tap</li> </ul>
Diagnosis	Countermeasure				
<p>Check the indoor unit fan operation. Check the temperature difference between return and supply air.</p> <p>Is the temperature difference between return and supply air 10-20degC at cooling?</p> <p>NO</p> <p>Is the compressor operating?</p> <p>NO</p> <p>Is the compressor rotation speed low?</p> <p>NO</p> <p>Check which control "Determination control of compressor rotation speed" or "Protective control by controlling compressor rotation speed" is appropriate to this phenomenon.</p> <p>Are the temperature conditions of room and outdoor air close to the rated conditions? (1)</p> <p>NO</p> <p>The unit is operating normally but is operating under the control for protecting compressor or other respective parts.</p>	<p>It is normal. (This unit is designed to start in the soft start mode by detecting the under dome temperature of compressor when it restart after power reset.)</p> <p>It is necessary to replace to higher capacity one or to install additional unit.</p> <p>Compressor refrigerant oil protection control at starting is activated.</p> <p>Compressor may be stopped by the error detection control. For the contents of control, refer to anomalous stop control by controlling compressor rotation speed of microcomputer control functions.</p> <p>Inspect the followings.</p> <ul style="list-style-type: none"> <li>• Minor clogging of filter</li> <li>• Minor clogging of heat exchanger</li> <li>• Minor short-circuit</li> <li>• Minor shortage of refrigerant amount</li> <li>• Poor compression of compressor</li> </ul> <p>Considering appropriate operation control, check suspicious points. Inspect the followings for reference.</p> <ul style="list-style-type: none"> <li>• Major clogging of filter</li> <li>• Major clogging of heat exchanger</li> <li>• Major short-circuit</li> <li>• Major shortage of refrigerant amount</li> <li>• Compressor protection ON</li> <li>• Indoor fan tap</li> </ul>				

2. Error detection method	
3. Condition of Error displayed	
4. Presumable cause   - Poor compression of compressor - Faulty expansion valve operation	

Note:

Error code Remote controller: None	LED	Green	Red	Content <b>Operates but does not heat</b>
	Indoor	Keeps flashing	Stays OFF	
	Outdoor	—	Stays OFF	

<b>1. Applicable model</b>	<b>5. Troubleshooting</b>		
All models	<b>Diagnosis</b>		<b>Countermeasure</b>
<b>2. Error detection method</b>	<pre> graph TD     Start[Check the indoor unit fan operation. Check the temperature difference between return and supply air.] --&gt; D1{Is the temperature difference between return and supply air 10-30degC at heating?}     D1 -- YES --&gt; D2{Does the heat load increase after installtion?}     D1 -- NO --&gt; D3{Is the compressor operating?}     D2 -- YES --&gt; C1[Mistake in model selection. Calculate heat load once again.]     D2 -- NO --&gt; D4{“WAIT” message is displayed (for 3 seconds) when performing cooling, defrosting and heating operations from the remote controller.}     D3 -- NO --&gt; D4     D3 -- YES --&gt; D5{Is the compressor rotation speed low?}     D4 -- YES --&gt; C2[Compressor refrigerant oil protection control at starting is activated.]     D4 -- NO --&gt; D5     D5 -- NO --&gt; C3[Inspect the followings. • Minor clogging of filter • Minor clogging of heat exchanger • Minor short-circuit • Minor shortage of refrigerant amount • Poor compression of compressor]     D5 -- YES --&gt; C4[Check which control “Determination control of compressor rotation speed” or “Protective control by controlling compressor rotation speed” is appropriate to this phenomenon.]     C4 --&gt; D6{Are the temperature conditions of room and outdoor air close to the rated conditions? (1)}     D6 -- YES --&gt; C5[Considering appropriate operation control, check suspicious points. Inspect the followings for reference. • Major clogging of filter • Major clogging of heat exchanger • Major short-circuit • Major shortage of refrigerant amount • Compressor protection ON • Indoor fan tap]     D6 -- NO --&gt; C6[The unit is operating normally but is operating under the contol for protecting compressor or other respective parts.]             </pre>		<p>It is normal. (This unit is designed to start in the soft start mode by detecting the under dome temperature of compressor when it restart after power reset.)</p> <p>It is necessary to replace to higher capacity one or to install additional unit.</p> <p>Compressor refrigerant oil protection control at starting is activated.</p> <p>Compressor may be stopped by the error detection control. For the contents of control, refer to anomalous stop control by controlling compressor rotation speed of microcomputer control functions.</p> <p>Inspect the followings. • Minor clogging of filter • Minor clogging of heat exchanger • Minor short-circuit • Minor shortage of refrigerant amount • Poor compression of compressor</p> <p>Considering appropriate operation control, check suspicious points. Inspect the followings for reference. • Major clogging of filter • Major clogging of heat exchanger • Major short-circuit • Major shortage of refrigerant amount • Compressor protection ON • Indoor fan tap</p>
<b>3. Condition of Error displayed</b>			
<b>4. Presumable cause</b>	<ul style="list-style-type: none"> <li>• Faulty 4-way valve operation</li> <li>• Poor compression of compressor</li> <li>• Faulty expansion valve operation</li> </ul>		

Note:

Error code Remote controller: None	LED	Green	Red	Content <b>Earth leakage breaker activated</b>
	Indoor	Stays OFF	Stays OFF	
	Outdoor	–	Stays OFF	

<b>1. Applicable model</b>
All models

<b>2. Error detection method</b>

<b>3. Condition of Error displayed</b>

<b>4. Presumable cause</b>
<ul style="list-style-type: none"> <li>• Defective compressor</li> <li>• Noise</li> </ul>

<b>5. Troubleshooting</b>	
<b>Diagnosis</b>	<b>Countermeasure</b>
<pre> graph TD     A{Are OK the insulation resistance and coil resistance of compressor?} -- NO --&gt; B[Replace compressor.*]     A -- YES --&gt; C{Is insulation of respective harnesses OK? Is any harness bitten between panel and casing or etc?}     C -- NO --&gt; D[Secure insulation resistance.]     C -- YES --&gt; E[Check the outdoor unit grounding wire/earth leakage breaker.]     </pre>	
<p><b>Check of the outdoor unit grounding wire/earth leakage breaker</b></p> <p>① Run an independent grounding wire from the grounding screw of outdoor unit to the grounding terminal on the distribution panel. (Do not connect to another grounding wire.)</p> <p>② In order to prevent malfunction of the earth leakage breaker itself, confirm that it is conformed to higher harmonic regulation.</p> <p><b>* Insulation resistance of compressor</b></p> <ul style="list-style-type: none"> <li>• Immediately after installation or when the unit has been left for long time without power supply, the insulation resistance may drop to a few MΩ because of refrigerant migrated in the compressor.</li> </ul> <p>When the earth breaker is activated at lower insulation resistance, check the following points.</p> <p>① 6 hours after power ON, check if the insulation resistance recovers to normal.</p> <p>When power ON, crankcase heater heat up compressor and evaporate the refrigerant migrated in the compressor.</p> <p>② Check if the earth leakage breaker is conformed to higher harmonic regulation or not.</p> <p>Since the unit is equipped with inverter, it is necessary to use components conformed to higher harmonic regulation in order to prevent malfunction of earth leakage breaker.</p>	

Note:

Error code Remote controller: None	LED	Green	Red	Content <b>Excessive noise/vibration (1/3)</b>
	Indoor	–	–	
	Outdoor	–	–	

1. Applicable model  
All models

2. Error detection method

3. Condition of Error displayed

4. Presumable cause
- ① Improper installation work
    - Improper anti-vibration work at installation
    - Insufficient strength of mounting face
  - ② Defective product
    - Before/after shipping from factory
  - ③ Improper adjustment during commissioning
    - Excess/shortage of refrigerant, etc.

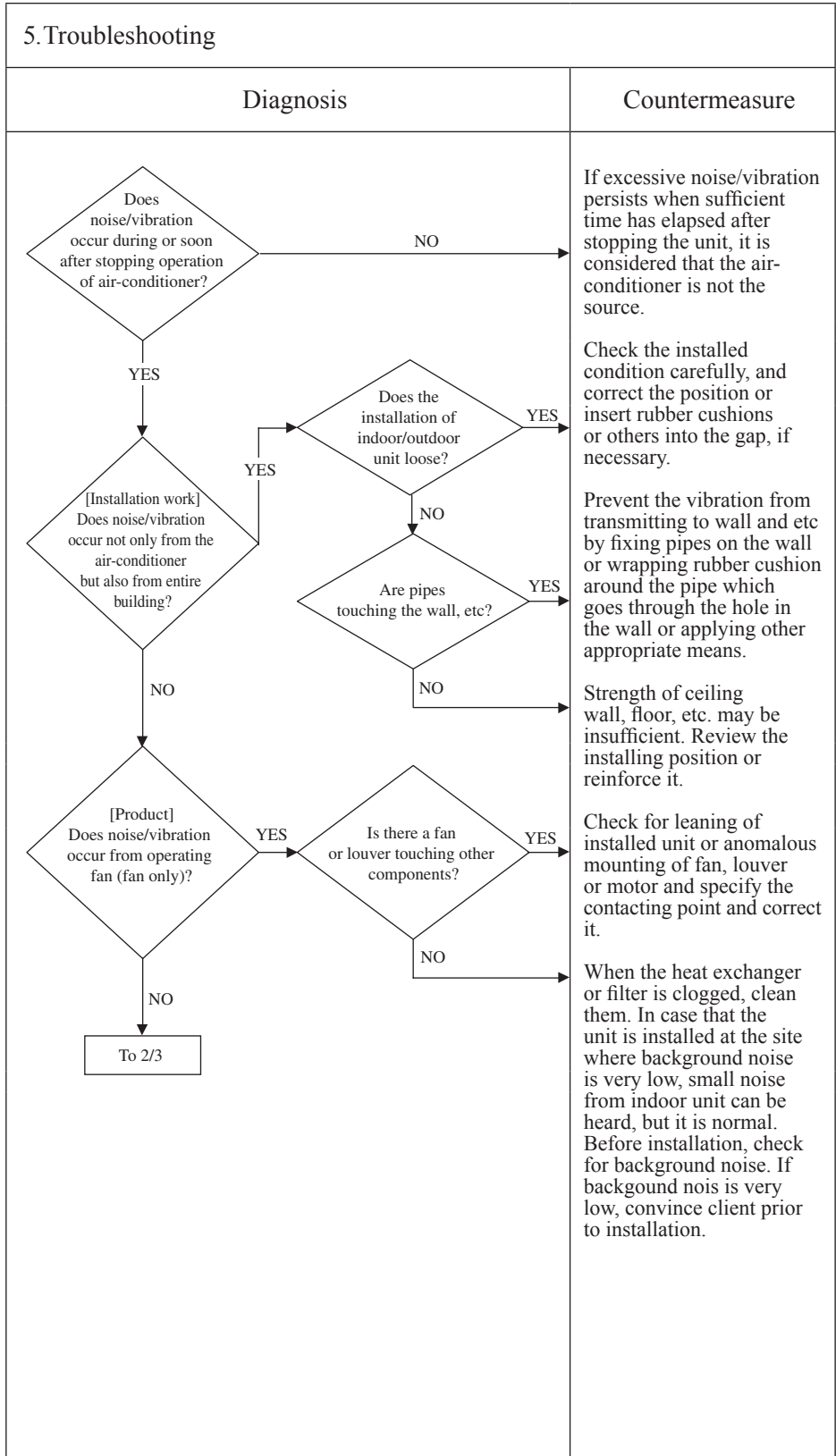

Note:

Error code Remote controller: None	LED	Green	Red	Content <b>Excessive noise/vibration (2/3)</b>
	Indoor	–	–	
	Outdoor	–	–	

<b>1. Applicable model</b>	<b>5. Troubleshooting</b>		
All models	<b>Diagnosis</b>		<b>Countermeasure</b>
<b>2. Error detection method</b>	<pre> graph TD     Start([From 1/3]) --&gt; D1{[Unit side] Does noise/vibration occur when the cooling/heating operation is performed normally?}     D1 -- YES --&gt; D2{Are the pipes contacting the casing?}     D2 -- YES --&gt; C1[Rearrange the piping to avoid contact with the casing.]     D2 -- NO --&gt; D3{Is it heard continuous hissing or roaring sound?}     D3 -- YES --&gt; C2[It is noise/vibration that is generated when the refrigerant gas or liquid flow through inside of piping of air-conditioner. It is likely to occur particularly during cooling or defrosting in the heating mode. It is normal.]     D3 -- NO --&gt; D4{Are hissing sounds heard at the startup or stopping?}     D4 -- YES --&gt; C3[The noise/vibration occurs when the refrigerant starts or stops flowing. It is normal.]     D4 -- NO --&gt; D5{Is blowing sound heard at the start/stop of defrosting during heating?}     D5 -- YES --&gt; C4[When the defrosting starts or stops during heating, the refrigerant flow is reversed due to switching 4-way valve. This causes a large change in pressure which produces a blowing sound. It may accompany also the hissing sounds as mentioned above. They are normal.]     D5 -- NO --&gt; D6{Is cracking noise heard during heating operation?}     D6 -- YES --&gt; C5[After the start or stop of heating operation or during defrosting, abrupt changes in temperature cause resin parts to shrink or expand. This is normal.]     D6 -- NO --&gt; D7{Hissing noise is heard during cooling operation or after stopping?}     D7 -- YES --&gt; C6[It is the sound produced by the drain pump that discharges drain from the indoor unit. The pump continues to run for 5 minutes after stopping the cooling operation. This is normal.]     D7 -- NO --&gt; C7[Apply the damper sealant at places considered to be the sources such as the pressure reducing mechanism (expansion valve), capillary, etc.]     D1 -- NO --&gt; End([To 3/3])     </pre>		
<b>3. Condition of Error displayed</b>			
<b>4. Presumable cause</b>			

Note:

Error code Remote controller: None	LED	Green	Red	Content <b>Excessive noise/vibration (3/3)</b>
	Indoor	–	–	
	Outdoor	–	–	

<b>1. Applicable model</b>	<b>5. Troubleshooting</b>	
All models	<b>Diagnosis</b>	<b>Countermeasure</b>
<b>2. Error detection method</b>	<div style="text-align: center;"> <div style="border: 1px solid black; width: 60px; height: 20px; margin: 0 auto; padding: 2px;">From 2/3</div> <div style="margin: 10px auto; width: 300px; height: 100px;"> </div> </div>	
<b>3. Condition of Error displayed</b>		
<b>4. Presumable cause</b>		
	<p>If insufficient cooling/heating problem happens due to anomalous operating conditions at cooling/heating, followings are suspicious.</p> <ul style="list-style-type: none"> <li>• Overcharge of refrigerant</li> <li>• Insufficient charge of refrigerant</li> <li>• Intrusion of air, nitrogen, etc.</li> </ul> <p>In such occasion, it is necessary to recover refrigerant, vacuum-dry and recharge refrigerant.</p> <p>* Since there could be many causes of noise/vibration, the above do not cover all. In such case, check the conditions when, where, how the noise/vibration occurs according to following check point.</p> <ul style="list-style-type: none"> <li>• Indoor/outdoor unit</li> <li>• Cooling/heating/fan mode</li> <li>• Startup/stop/during operation</li> <li>• Operating condition (Indoor/outdoor temperatures, pressure)</li> <li>• Time it occurred</li> <li>• Operation data retained by the remote controller such as compressor rotation speed, heat exchanger temperature, EEV opening degree, etc.</li> <li>• Tone (If available, record the noise)</li> <li>• Any other anomalies</li> </ul>	

Note:



Error code Remote controller: None	LED	Green	Red	Content <h2>Louver motor failure</h2>
	Indoor	Keeps flashing	Stays OFF	
	Outdoor	–	Stays OFF	

<b>1. Applicable model</b>
All models

<b>2. Error detection method</b>

<b>3. Condition of Error displayed</b>

<b>4. Presumable cause</b>
<ul style="list-style-type: none"> <li>• Defective LM</li> <li>• LM wire breakage</li> <li>• Faulty indoor control PCB</li> </ul>

<b>5. Troubleshooting</b>	
<b>Diagnosis</b>	<b>Countermeasure</b>
<p>▲ Check at the indoor unit side.</p> <div style="border: 1px solid black; padding: 5px; width: fit-content; margin-bottom: 10px;">Operate after waiting for more than 1 minute.</div> <pre> graph TD     Start[Operate after waiting for more than 1 minute.] --&gt; Q1{Does the louver operate at the power on?}     Q1 -- NO --&gt; Q2{Is LM wiring broken?}     Q2 -- YES --&gt; C1[Repair wiring.]     Q2 -- NO --&gt; Q3{Is LM locked?}     Q3 -- NO --&gt; C2[Defective indoor control PCB → Replace.]     Q3 -- YES --&gt; C3[Replace LM.]     Q1 -- YES --&gt; Q4{Is the louver operable with the remote controller?}     Q4 -- YES --&gt; C4[Normal]     Q4 -- NO --&gt; C5[Adjust LM lever and then check again.]                     </pre> <p style="text-align: center;">LM: louver motor</p>	

Note:

<b>Error code</b> Remote controller: None	<b>LED</b>	<b>Green</b>	<b>Red</b>	<b>Content</b> Power supply system error (Power supply to indoor control PCB)
	Indoor	Stays OFF	Stays OFF	
	Outdoor	–	Stays OFF	

**1. Applicable model**  
All models

**2. Error detection method**

**3. Condition of Error displayed**

- 4. Presumable cause**
- Misconnection or breakage of connecting wires
  - Blown fuse
  - Faulty indoor control or power PCB
  - Broken harness
  - Faulty outdoor control PCB (Noise filter)

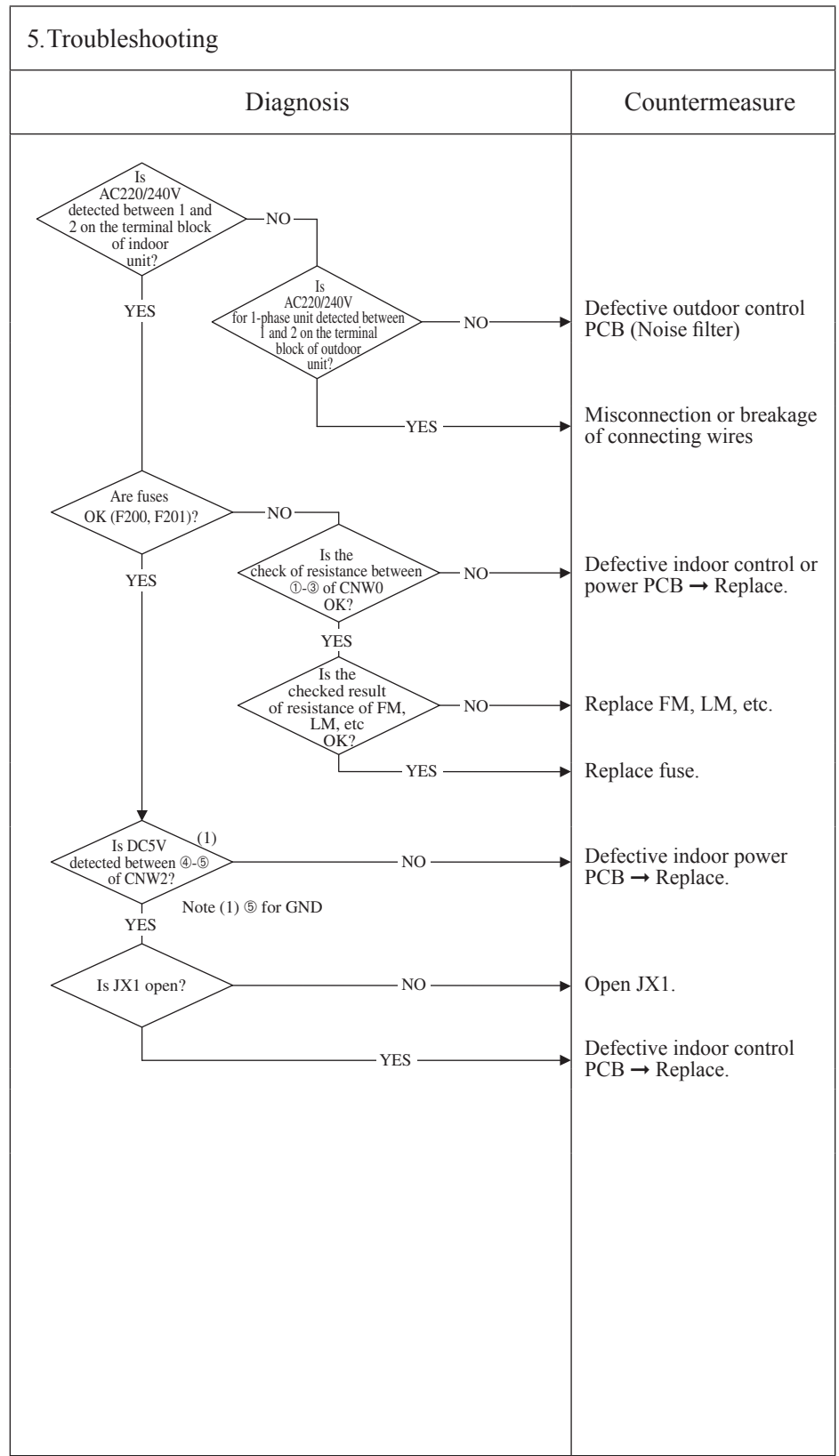

Note:

Error code Remote controller: None	LED	Green	Red	Content <b>Power supply system error (Power supply to remote controller)</b>
	Indoor	Keeps flashing	Stays OFF	
	Outdoor	—	Stays OFF	

<b>1. Applicable model</b>	<b>5. Troubleshooting</b>		
All models	<b>Diagnosis</b>	<b>Countermeasure</b>	
<b>2. Error detection method</b>	<pre> graph TD     D1{Isn't there any loose connection of remote controller wires?}     D2{Isn't remote controller wire broken or short-circuited?}     P1[Disconnect remote controller wires.]     D3{Is DC15V or higher detected between X-Y of indoor unit terminal block?}     D4{Is DC180V between ①-② of CNW2?}          D1 -- YES --&gt; C1[Correct.]     D1 -- NO --&gt; D2     D2 -- YES --&gt; C2[Replace wires.]     D2 -- NO --&gt; P1     P1 --&gt; D3     D3 -- YES --&gt; C3[Replace remote controller.]     D3 -- NO --&gt; D4     D4 -- YES --&gt; C4[Defective indoor control PCB -&gt; Replace.]     D4 -- NO --&gt; C5[Defective indoor power PCB -&gt; Replace.]         </pre>		
<b>3. Condition of Error displayed</b>			
<b>4. Presumable cause</b>	<ul style="list-style-type: none"> <li>• Remote controller wire breakage/short-circuit</li> <li>• Defective remote controller</li> <li>• Malfunction by noise</li> <li>• Faulty indoor power PCB</li> <li>• Broken harness</li> <li>• Faulty indoor control PCB</li> </ul>		

Note:

Error code Remote controller: INSPECT I/U	LED	Green	Red	Content <b>INSPECT I/U</b> (When 1 or 2 remote controllers are connected)
	Indoor	Keeps flashing	Stays OFF	
	Outdoor	—	Stays OFF	

<b>1. Applicable model</b>
All models
<b>2. Error detection method</b>
Communication between indoor unit and remote controller is disabled for more than 30 minutes after the power on.
<b>3. Condition of Error displayed</b>
Same as above
<b>4. Presumable cause</b>
<ul style="list-style-type: none"> <li>• Improper setting</li> <li>• Surrounding environment</li> <li>• Defective remote controller communication circuit</li> <li>• Faulty indoor control PCB</li> </ul>

<b>5. Troubleshooting</b>	
<b>Diagnosis</b>	<b>Countermeasure</b>
<pre> graph TD     Q1{Are 2 units of remote controller connected?}     Q2{Is it set at the slave remote controller?}     Q3{Does it become normal?}     Q4{Do more than one indoor units have the same address?}     Q5{Are remote controller wires laid along high voltage wires?}     Q6{Does DM start 60 seconds later automatically.}          Q1 -- YES --&gt; S1[Set one remote controller for "Master" and the other for "Slave"]     S1 --&gt; Q3     Q3 -- NO --&gt; Q4     Q1 -- NO --&gt; Q2     Q2 -- YES --&gt; C1[Set SW1 on remote controller PCB at "Master".]     Q2 -- NO --&gt; Q4          Q4 -- YES --&gt; C2[Set address again. (SW2 on indoor control PCB)]     Q4 -- NO --&gt; Q5          Q5 -- YES --&gt; C3[Separate remote controller wires from high voltage wires.]     Q5 -- NO --&gt; S2[Disconnect the connecting wire ③ between the indoor and outdoor unit.]     S2 --&gt; S3[Power supply reset]     S3 --&gt; Q6          Q6 -- YES --&gt; C4[Defective indoor control PCB -&gt; Replace.]     Q6 -- NO --&gt; C5[Defective remote controller -&gt; Change.]     </pre>	

Note: If any error is detected 30 minutes after displaying “WAIT” on the remote controller, the display changes to “INSPECT I/U”.

Error code Remote controller: INSPECT I/U	LED	Green	Red	Content <b>INSPECT I/U</b> (Connection of 3 units or more remote controller)
	Indoor	Keeps flashing	Stays OFF	
	Outdoor	—	Stays OFF	

<b>1. Applicable model</b>
All models

<b>2. Error detection method</b>
Indoor unit cannot communicate for more than 30 minutes after the power on with remote controller.

<b>3. Condition of Error displayed</b>
Same as above

<b>4. Presumable cause</b>
<ul style="list-style-type: none"> <li>• Improper setting</li> <li>• Surrounding environment</li> <li>• Defective remote controller communication circuit</li> <li>• Faulty indoor control or power PCB</li> <li>• Faulty outdoor sub PCB</li> </ul>

<b>5. Troubleshooting</b>																				
<table border="1"> <thead> <tr> <th>Diagnosis</th> <th>Countermeasure</th> </tr> </thead> <tbody> <tr> <td> <p>Are more than 3 units of remote controller connected?</p> <p>YES →</p> <p>NO ↓</p> </td> <td>Reduce to 2 units or less.</td> </tr> <tr> <td> <p>Does remote controller display "Slave"?</p> <p>YES →</p> <p>NO ↓</p> </td> <td>Change remote controller setting to "Master". (SW1 on remote controller PCB)</td> </tr> <tr> <td> <p>Do more than one indoor units have the same address?</p> <p>YES →</p> <p>NO ↓</p> </td> <td>Change address. (SW2 on indoor control PCB)</td> </tr> <tr> <td> <p>Is it set to a slave indoor unit. SW5-1, 2?</p> <p>YES →</p> <p>NO ↓</p> </td> <td>Change to master. (SW5-1, 2 on indoor control PCB)</td> </tr> <tr> <td> <p>Is there loose or wrong connection at the terminal of wiring between indoor and outdoor units?</p> <p>YES →</p> <p>NO ↓</p> </td> <td>Correct</td> </tr> <tr> <td> <p>Is the grounding wire connected properly?</p> <p>NO →</p> <p>YES ↓</p> </td> <td>Correct</td> </tr> <tr> <td> <p>Is approx. DC20V detected between ②-③ on the outdoor unit terminal block?</p> <p>NO →</p> <p>YES ↓</p> </td> <td>Defective outdoor sub PCB → Replace.</td> </tr> <tr> <td> <p>Is approx. DC20V detected between ②-③ on the indoor unit terminal block?</p> <p>NO →</p> <p>YES ↓</p> </td> <td>Broken connecting wire → Correct.</td> </tr> <tr> <td> <p>YES →</p> </td> <td>Defective indoor control or power PCB → Replace.</td> </tr> </tbody> </table>	Diagnosis	Countermeasure	<p>Are more than 3 units of remote controller connected?</p> <p>YES →</p> <p>NO ↓</p>	Reduce to 2 units or less.	<p>Does remote controller display "Slave"?</p> <p>YES →</p> <p>NO ↓</p>	Change remote controller setting to "Master". (SW1 on remote controller PCB)	<p>Do more than one indoor units have the same address?</p> <p>YES →</p> <p>NO ↓</p>	Change address. (SW2 on indoor control PCB)	<p>Is it set to a slave indoor unit. SW5-1, 2?</p> <p>YES →</p> <p>NO ↓</p>	Change to master. (SW5-1, 2 on indoor control PCB)	<p>Is there loose or wrong connection at the terminal of wiring between indoor and outdoor units?</p> <p>YES →</p> <p>NO ↓</p>	Correct	<p>Is the grounding wire connected properly?</p> <p>NO →</p> <p>YES ↓</p>	Correct	<p>Is approx. DC20V detected between ②-③ on the outdoor unit terminal block?</p> <p>NO →</p> <p>YES ↓</p>	Defective outdoor sub PCB → Replace.	<p>Is approx. DC20V detected between ②-③ on the indoor unit terminal block?</p> <p>NO →</p> <p>YES ↓</p>	Broken connecting wire → Correct.	<p>YES →</p>	Defective indoor control or power PCB → Replace.
Diagnosis	Countermeasure																			
<p>Are more than 3 units of remote controller connected?</p> <p>YES →</p> <p>NO ↓</p>	Reduce to 2 units or less.																			
<p>Does remote controller display "Slave"?</p> <p>YES →</p> <p>NO ↓</p>	Change remote controller setting to "Master". (SW1 on remote controller PCB)																			
<p>Do more than one indoor units have the same address?</p> <p>YES →</p> <p>NO ↓</p>	Change address. (SW2 on indoor control PCB)																			
<p>Is it set to a slave indoor unit. SW5-1, 2?</p> <p>YES →</p> <p>NO ↓</p>	Change to master. (SW5-1, 2 on indoor control PCB)																			
<p>Is there loose or wrong connection at the terminal of wiring between indoor and outdoor units?</p> <p>YES →</p> <p>NO ↓</p>	Correct																			
<p>Is the grounding wire connected properly?</p> <p>NO →</p> <p>YES ↓</p>	Correct																			
<p>Is approx. DC20V detected between ②-③ on the outdoor unit terminal block?</p> <p>NO →</p> <p>YES ↓</p>	Defective outdoor sub PCB → Replace.																			
<p>Is approx. DC20V detected between ②-③ on the indoor unit terminal block?</p> <p>NO →</p> <p>YES ↓</p>	Broken connecting wire → Correct.																			
<p>YES →</p>	Defective indoor control or power PCB → Replace.																			

Note: If any error is detected 30 minutes after displaying "WAIT" on the remote controller, the display changes to "INSPECT I/U".

Error code Remote controller: 🟡WAIT🟡	LED	Green	Red	Content <b>Communication error at initial operation (1/3)</b>
	Indoor	Keeps flashing	Stays OFF	
	Outdoor	–	Stays OFF	

**1. Applicable model**  
All models  
When the remote controller LCD displays “🟡WAIT🟡” 2 minutes after the power on.

**2. Error detection method**

**3. Condition of Error displayed**

**4. Presumable cause**

- Blown fuse
- Faulty outdoor sub PCB
- Connection between PCB's
- Faulty indoor control PCB
- Defective remote controller
- Broken remote controller wire

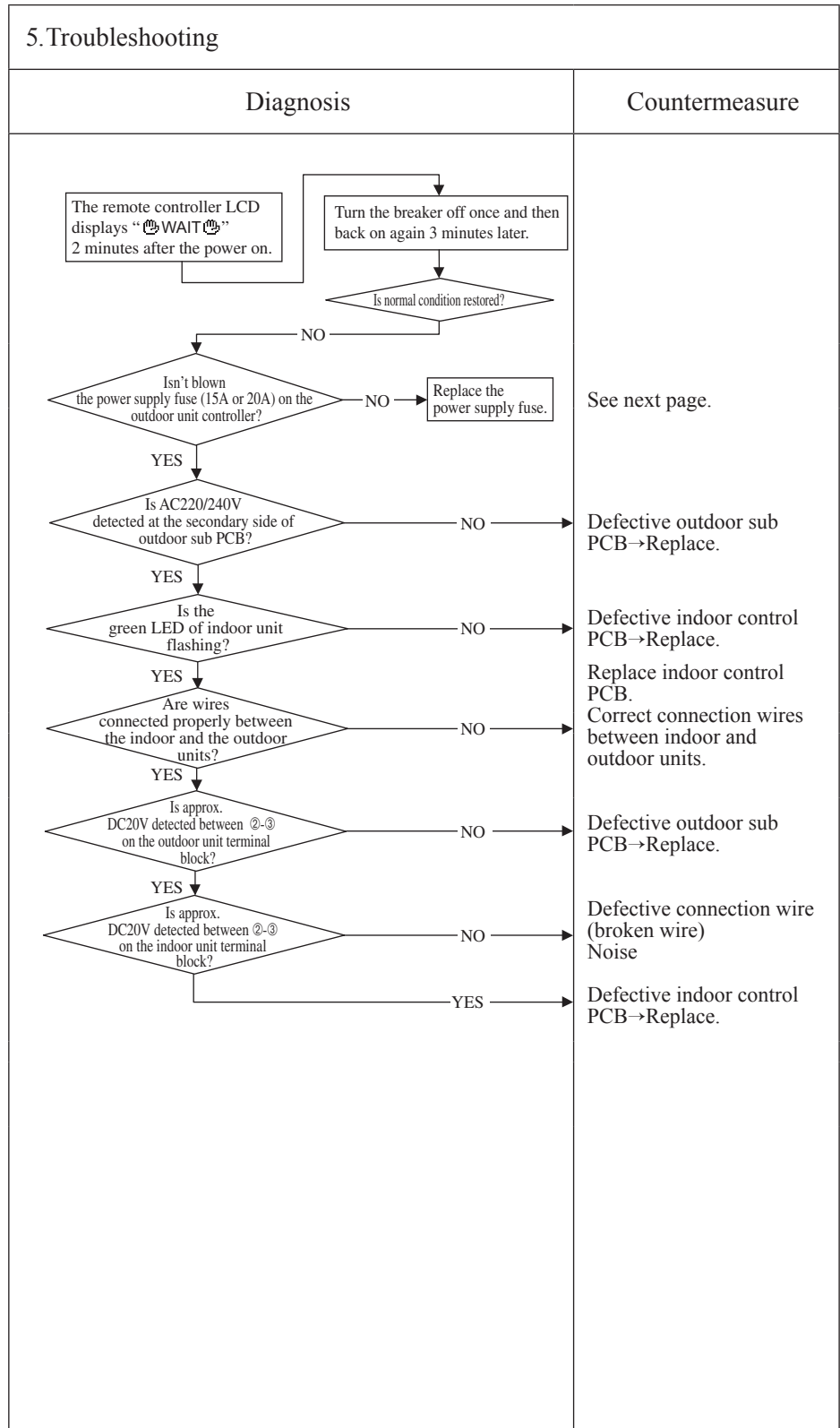

Note: If any anomaly is detected during communication, the error code E5 is displayed. Inspection procedure is same as above. (Excluding matters related to connection) When the power supply is reset after the occurrence of E5, the LED will display “🟡WAIT🟡” if the anomaly continues. If the breaker ON/OFF is repeated in a short period of time (within 1 minute), “🟡WAIT🟡” may be displayed. In such occasion, turn the breaker off and wait for 3 minutes.

Error code Remote controller: 🗄️WAIT🗄️	LED	Green	Red	Content <b>Communication error at initial operation (2/3)</b>
	Indoor	Keeps flashing	Stays OFF	
	Outdoor	–	Stays OFF	

**1. Applicable model**

All models

When the fuse is blown, the method to inspect outdoor sub PCB before replacing the power supply fuse

**2. Error detection method**

**3. Condition of Error displayed**

**4. Presumable cause**

- Blown fuse
- Faulty outdoor sub PCB
- Faulty outdoor main PCB
- Faulty reactor

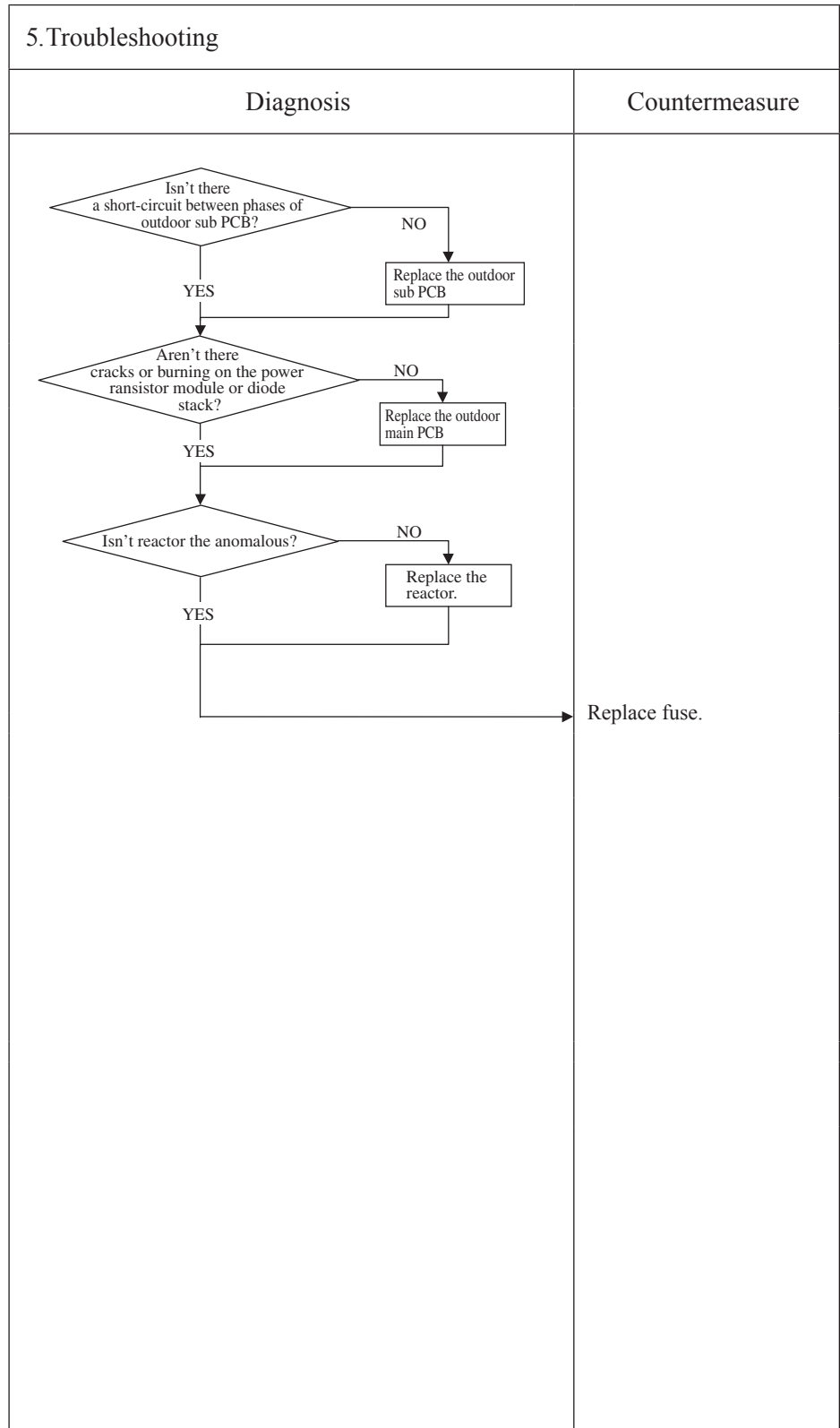

Note:

<b>Error code</b> Remote controller: 🕒 WAIT 🕒	<b>LED</b>	<b>Green</b>	<b>Red</b>	<b>Content</b> Communication error at initial operation (3/3)
	Indoor	Keeps flashing	Stays OFF	
	Outdoor	–	Stays OFF	

**1. Applicable model**

All models

When the remote controller display is extinguished after the power on.

**2. Error detection method**

**3. Condition of Error displayed**

- 4. Presumable cause**
- Blown fuse
  - Connection between PCB's
  - Blown fuse
  - Faulty indoor control PCB
  - Defective remote controller
  - Wire breakage on remote controller
  - Faulty outdoor sub PCB

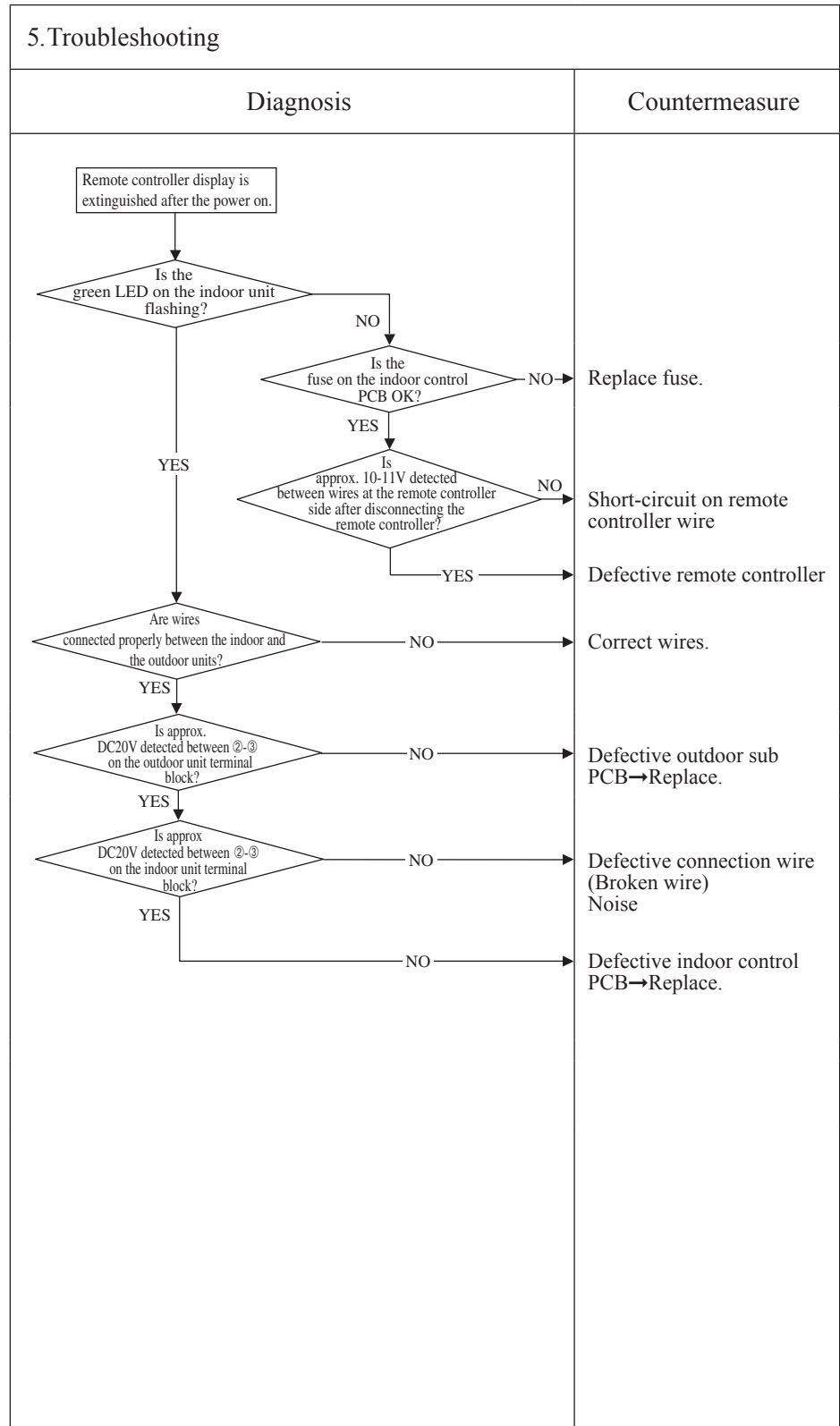

Note:



Error code Remote controller: E1	LED	Green	Red	Content <b>Remote controller communication circuit error</b>
	Indoor	Keeps flashing	Stays OFF	
	Outdoor	—	Stays OFF	

**1. Applicable model**  
All models

**2. Error detection method**  
When normal communication between the remote controller and the indoor unit is interrupted for more than 2 minutes. (Detectable only with the remote controller)

**3. Condition of Error displayed**  
Same as above

- 4. Presumable cause**
- Defective communication circuit between remote controller-indoor unit
  - Noise
  - Defective remote controller
  - Faulty indoor control PCB

**5. Troubleshooting**

Diagnosis	Countermeasure
<pre> graph TD     A{Is it possible to reset normally by the power reset?} -- YES --&gt; B[Malfunction by noise Check peripheral environment.]     A -- NO --&gt; C[Turn SW7-1 to OFF. → ON Remove the wire ③ connecting between indoor/outdoor units.]     C --&gt; D[Power reset]     D --&gt; E{Does the drain pump restart automatically 1 minute later?}     E -- YES --&gt; F[Defective indoor control PCB → Replace.]     E -- NO --&gt; G[Defective remote controller → Replace.]     </pre> <p>Note (2) Does the remote controller still display “WAIT” even after 3 minutes?</p>	

Note: If the indoor unit cannot communicate normally with the remote controller for 180 seconds, the indoor control PCB starts to reset automatically.

Error code Remote controller: E5	LED	Green	Red	Content <b>Communication error during operation</b>
	Indoor	Keeps flashing	2 times flash	
	Outdoor	—	6 times flash	

<p><b>1. Applicable model</b></p> <p>All models</p>	<b>5. Troubleshooting</b>		
<p><b>2. Error detection method</b></p> <p>When normal communication between indoor and outdoor unit is interrupted for more than 2 minutes.</p>	<b>Diagnosis</b>	<b>Countermeasure</b>	
<p><b>3. Condition of Error displayed</b></p> <p>Same as above is detected during operation.</p>	<pre> graph TD     D1{Is the connection of signal wires at the outdoor unit side OK?}     Note1[Note (1) Inspect faulty connections (disconnection, looseness) on the outdoor unit terminal block.]     D2{Is the connection of signal wires between indoor-outdoor units OK?}     Note2[Note (2) Check for faulty connection or breakage of signal wires between indoor-outdoor units.]     P[Power reset]     D3{Has the remote controller LCD returned to normal state?}          D1 -- NO --&gt; C1[Repair signal wires.]     D1 -- YES --&gt; D2     D2 -- NO --&gt; C2[Repair signal wires.]     D2 -- YES --&gt; P     P --&gt; D3     D3 -- NO --&gt; C3[Defective outdoor sub PCB (Defective network communication circuit) -&gt; Replace.]     D3 -- YES --&gt; C4[Unit is normal. (Malfunction by temporary noise, etc.)]                     </pre>		
<p><b>4. Presumable cause</b></p> <ul style="list-style-type: none"> <li>• Unit No. setting error</li> <li>• Broken remote controller wire</li> <li>• Faulty remote controller wire connection</li> <li>• Faulty outdoor sub PCB</li> </ul>			

Note:

Error code Remote controller: E6	LED	Green	Red	Content <b>Indoor heat exchanger temperature thermistor anomaly</b>
	Indoor	Keeps flashing	1 time flash	
	Outdoor	–	Stays OFF	

**1. Applicable model**  
All models

**2. Error detection method**  
Anomalously low temperature or high temperature (resistance) is detected on the indoor heat exchanger thermistor (ThI-R1, R2 or R3).

**3. Condition of Error displayed**

- When the temperature thermistor detects -50°C or lower for 5 seconds continuously, the compressor stops. After 3-minutes delay, the compressor starts again automatically, but if this error occurs again within 60 minutes after the initial detection.
- Or if 70°C or higher is detected for 5 seconds continuously.

**4. Presumable cause**

- Defective indoor heat exchanger thermistor connector
- Indoor heat exchanger temperature thermistor anomaly
- Faulty indoor control PCB

**5. Troubleshooting**

Diagnosis	Countermeasure
<p>Is the connection of indoor heat exchanger temperature thermistor connector OK?</p> <p>NO →</p> <p>YES →</p> <p>Are characteristics of indoor heat exchanger temperature thermistor OK?</p> <p>NO →</p> <p>YES →</p>	<p>Correct. → Insert connector securely.</p> <p>Defective indoor heat exchanger temperature thermistor → Replace.</p> <p>Defective indoor control PCB → Replace. (Defective indoor unit heat exchanger temperature thermistor input circuit)</p>

(Broken wire) **Temperature-resistance characteristic**

(Shot circuit)

Note:

Error code Remote controller: E7	LED	Green	Red	Content <b>Return air temperature thermistor anomaly</b>
	Indoor	Keeps flashing	1 time flash	
	Outdoor	–	Stays OFF	

**1. Applicable model**  
All models

**2. Error detection method**  
Anomalously low temperature or high temperature (resistance) is detected by indoor return air temperature thermistor (ThI-A)

**3. Condition of Error displayed**

- When the temperature thermistor detects -50°C or lower for 5 seconds continuously, the compressor stops. After 3-minute delay, the compressor starts again automatically, but if this error occurs again within 60 minutes after the initial detection.

**4. Presumable cause**

- Defective return air temperature thermistor connector
- Defective return air temperature thermistor
- Faulty indoor control PCB

**5. Troubleshooting**

Diagnosis	Countermeasure
<p>Is the connection of return air temperature thermistor connector OK?</p> <p>NO →</p> <p>YES →</p> <p>Are the characteristics of return air temperature thermistor OK?</p> <p>NO →</p> <p>YES →</p>	<p>Correct. → Connect connector.</p> <p>Defective return air temperature thermistor → Replace.</p> <p>Defective indoor control PCB → Replace. (Defective return air temperature thermistor input circuit)</p>

Temperature-resistance characteristic

Temperature (°C)	Resistance (kΩ)
0	15
10	10
20	6
25	5
30	4
40	3
50	2

Note:

Error code Remote controller: E8	LED	Green	Red	Content <b>Heating overload operation</b>
	Indoor	Keeps flashing	1 time flash	
	Outdoor	—	Stays OFF	

**1. Applicable model**  
All models

**2. Error detection method**  
Indoor heat exchanger temperature thermistor (ThI-R1, R2, R3)

**3. Condition of Error displayed**  
When it is detected 5 times within 60 minutes from initial detection or when the overload condition is detected for 6 minutes continuously.

**4. Presumable cause**

- Clogged air filter
- Defective indoor heat exchanger temperature thermistor connector
- Defective indoor heat exchanger temperature thermistor
- Anomalous refrigerant system

**5. Troubleshooting**

Diagnosis	Countermeasure
<pre> graph TD     Q1{Is the air filter clogged?} -- YES --&gt; C1[Wash.]     Q1 -- NO --&gt; Q2{Is the indoor heat exchanger temperature thermistor connection OK?}     Q2 -- NO --&gt; C2[Defective indoor heat exchanger temperature thermistor connector → Correct.]     Q2 -- YES --&gt; Q3{Are the characteristics of indoor heat exchanger temperature thermistor OK? (2)}     Q3 -- NO --&gt; C3[Defective indoor heat exchanger temperature thermistor.]     Q3 -- YES --&gt; B1[Check the error data with the remote controller.]     B1 --&gt; Q4{Is the unit operating in the state of heating overload?}     Q4 -- NO --&gt; C4[Check refrigerant system.]     Q4 -- YES --&gt; C5[Adjust]                     </pre>	
<p>Note (1) Judge if it is in the state of overload or not as follows.</p> <ul style="list-style-type: none"> <li>▲ Is there any short-circuit of air?</li> <li>▲ Isn't there any fouling or clogging on the indoor heat exchanger?</li> <li>▲ Is the outdoor fan control normal?</li> <li>▲ Isn't the indoor and outdoor air temperature too high?</li> </ul> <p>Note (2) For characteristics of indoor heat exchanger temperature thermistor, see the error display E6.</p> <p>The graph shows a horizontal line representing indoor heat exchanger temperature. A vertical line at 56°C is labeled 'Reset'. A vertical line at 63°C is labeled 'Error stop'. The x-axis is labeled 'Indoor heat exchanger temperature (°C)'.</p>	

Note: During heating operation; After starting compressor, compressor rotation speed is decreased by detecting indoor heat exchanger temperature (ThI-R) in order to control high pressure.

Error code Remote controller: E9	LED	Green	Red	Content <h2 style="text-align: center;">Drain trouble</h2>
	Indoor	Keeps flashing	1 time flash	
	Outdoor	–	Stays OFF	

<b>1. Applicable model</b>
All models

<b>2. Error detection method</b>
Float switch is activated

<b>3. Condition of Error displayed</b>
If the float switch OPEN is detected for 3 seconds continuously or if float switch connector or wire is disconnected.

<b>4. Presumable cause</b>
<ul style="list-style-type: none"> <li>• Defective indoor control or power PCB</li> <li>• Float switch setting error</li> <li>• Humidifier DM interlock setting error</li> <li>• Optional equipment setting error</li> <li>• Drain piping error</li> <li>• Defective drain motor</li> <li>• Disconnection of drain motor wiring</li> </ul>

<b>5. Troubleshooting</b>	
<b>Diagnosis</b>	<b>Countermeasure</b>
<pre> graph TD     Start[Check the error data in the remote controller.] --&gt; Q1{Is there any overflow?}     Q1 -- NO --&gt; Q2{Is the CNI connected firmly?}     Q1 -- YES --&gt; Q3{Is the humidifier connected?}     Q2 -- NO --&gt; C1[Defective indoor control PCB -&gt; Replace.]     Q2 -- YES --&gt; Q4{Is there any anomaly on the optional equipment?}     Q3 -- YES --&gt; Q5{Is the humidifier Drain Motor interlocked by the indoor unit function setting of remote controller?}     Q3 -- NO --&gt; C2[Correct setting to "Humidifier DM interlock".]     Q4 -- YES --&gt; C3[Check optional equipment]     Q4 -- NO --&gt; C1     Q5 -- YES --&gt; StartDM[Drain motor ON from the remote controller]     Q5 -- NO --&gt; C2     StartDM --&gt; Q6{Does DM operate?}     Q6 -- YES --&gt; Q7{Is the drain piping unclogged? Is the drain pipe slop OK?}     Q6 -- NO --&gt; Q8{Is AC220/240V detected at CNR connector?}     Q7 -- YES --&gt; C4[Check drain motor.]     Q7 -- NO --&gt; C5[Correct.]     Q8 -- YES --&gt; C6[Check wiring of drain motor]     Q8 -- NO --&gt; C7[Defective indoor power PCB -&gt; Replace.]     </pre>	

Note: When this error occurred at power ON, disconnection of wire or connector of the float switch is suspected. Check and correct it (or replace it, if necessary).

Error code Remote controller: E10	LED	Green	Red	Content Excessive number of connected indoor units (more than 17 units) by controlling with one remote controller
	Indoor	Keeps flashing	Stays OFF	
	Outdoor	–	Stays OFF	

<b>1.Applicable model</b>
All models

<b>2. Error detection method</b>
When it detects more than 17 of indoor units connected to one remote controller

<b>3. Condition of Error displayed</b>
Same as above

<b>4. Presumable cause</b>
<ul style="list-style-type: none"> <li>• Excessive number of indoor units connected</li> <li>• Defective remote controller</li> </ul>

<b>5. Troubleshooting</b>	
<b>Diagnosis</b>	<b>Countermeasure</b>
<pre> graph TD     A{Aren't more than 17 indoor units connected to one remote controller?} -- NO --&gt; B[Defective remote controller -&gt; Replace.]     A -- YES --&gt; C[Reduce to 16 or less units.]             </pre>	

Note:

Error code Remote controller: E16	LED	Green	Red	Content <b>Indoor fan motor anomaly</b>
	Indoor	Keeps flashing	Stays OFF	
	Outdoor	–	Stays OFF	

**1. Applicable model**  
All models

**2. Error detection method**  
Detected by rotation speed of indoor fan motor

**3. Condition of Error displayed**  
When actual rotation speed of indoor fan motor drops to lower than 200rpm for 30 seconds continuously, the compressor and the indoor fan motor stop. After 2-seconds, it starts again automatically, but if this error occurs 4 times within 60 minutes after the initial detection.

**4. Presumable cause**

- Defective indoor power PCB
- Foreign material at rotational area of fan propeller
- Defective fan motor
- Dust on control PCB
- Blown fuse
- External noise, surge

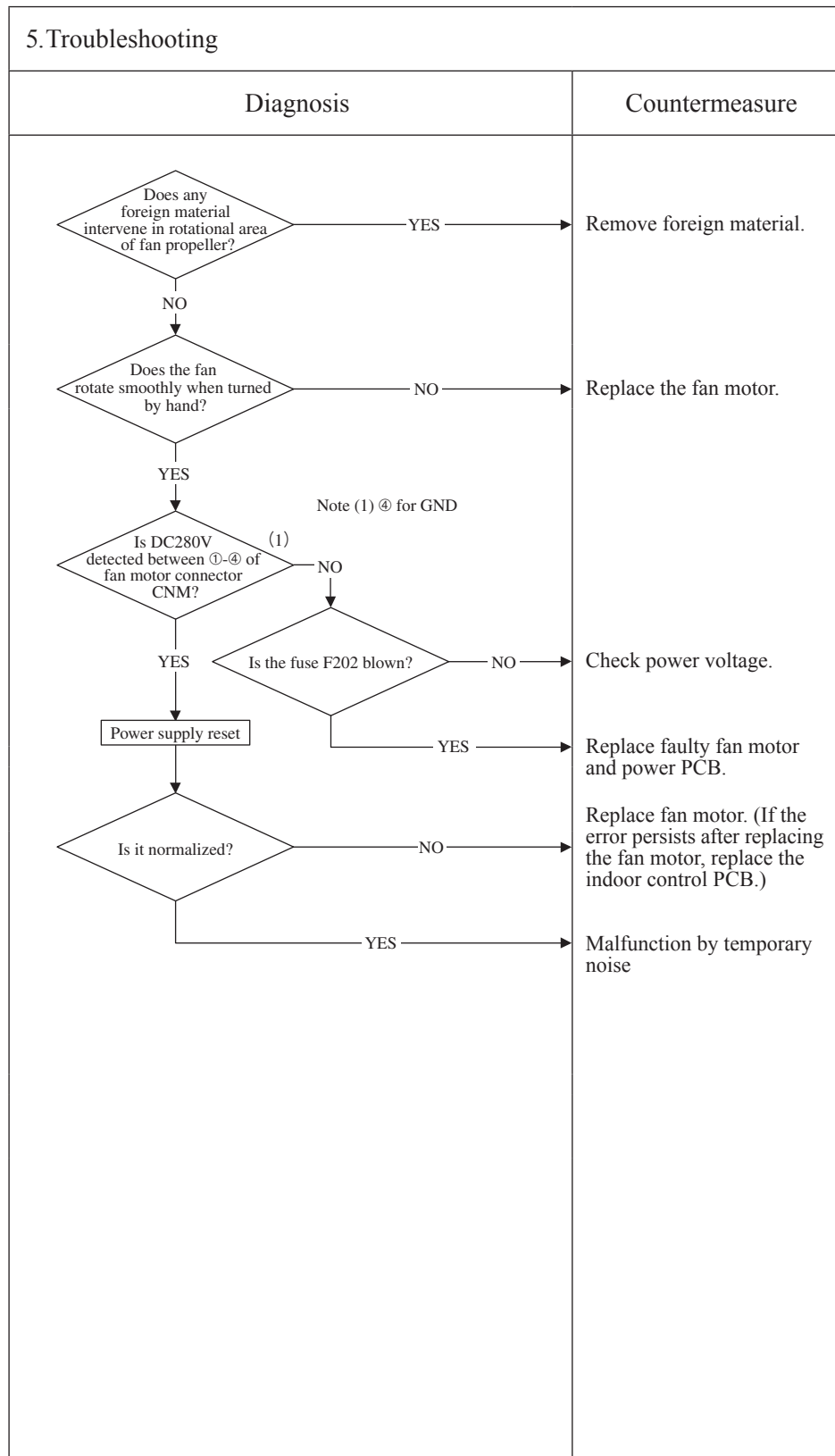

Note:



Error code Remote controller: E19	LED	Green	Red	Content <b>Indoor unit operation check, drain motor check setting error</b>
	Indoor	Keeps flashing	1 time flash	
	Outdoor	–	Stays OFF	

<b>1. Applicable model</b>
All models

<b>2. Error detection method</b>
After indoor operation check, when the communication between indoor and outdoor unit is established and SW7-1 is still kept ON.

<b>3. Condition of Error displayed</b>
Same as above

<b>4. Presumable cause</b>
Mistake in SW7-1 setting (Due to forgetting to turn OFF SW7-1 after indoor operation check)

<b>5. Troubleshooting</b>	
<b>Diagnosis</b>	<b>Countermeasure</b>
<pre> graph TD     Start[E19 occurs when the power ON] --&gt; Decision{Is SW7-1 on the indoor control PCB ON?}     Decision -- NO --&gt; Countermeasure1[Defective indoor control PCB (Defective SW7) -&gt; Replace]     Decision -- YES --&gt; Countermeasure2[Turn SW7-1 on the indoor control PCB OFF and reset the power]         </pre>	

Note:

Error code Remote controller: E28	LED	Green	Red	Content <b>Remote controller temperature thermistor anomaly</b>
	Indoor	Keeps flashing	Stays OFF	
	Outdoor	–	Stays OFF	

**1. Applicable model**  
All models

**2. Error detection method**  
Detection of anomalously low temperature (resistance) of remote controller temperature thermistor (Thc)

**3. Condition of Error displayed**  
When the temperature thermistor detects  $-50^{\circ}\text{C}$  or lower for 5 seconds continuously, the compressor stops. After 3-minutes delay, the compressor starts again automatically, but if this error occurs again within 60 minutes after the initial detection.

**4. Presumable cause**

- Faulty connection of remote controller temperature thermistor
- Defective remote controller temperature thermistor
- Defective remote controller PCB

**5. Troubleshooting**

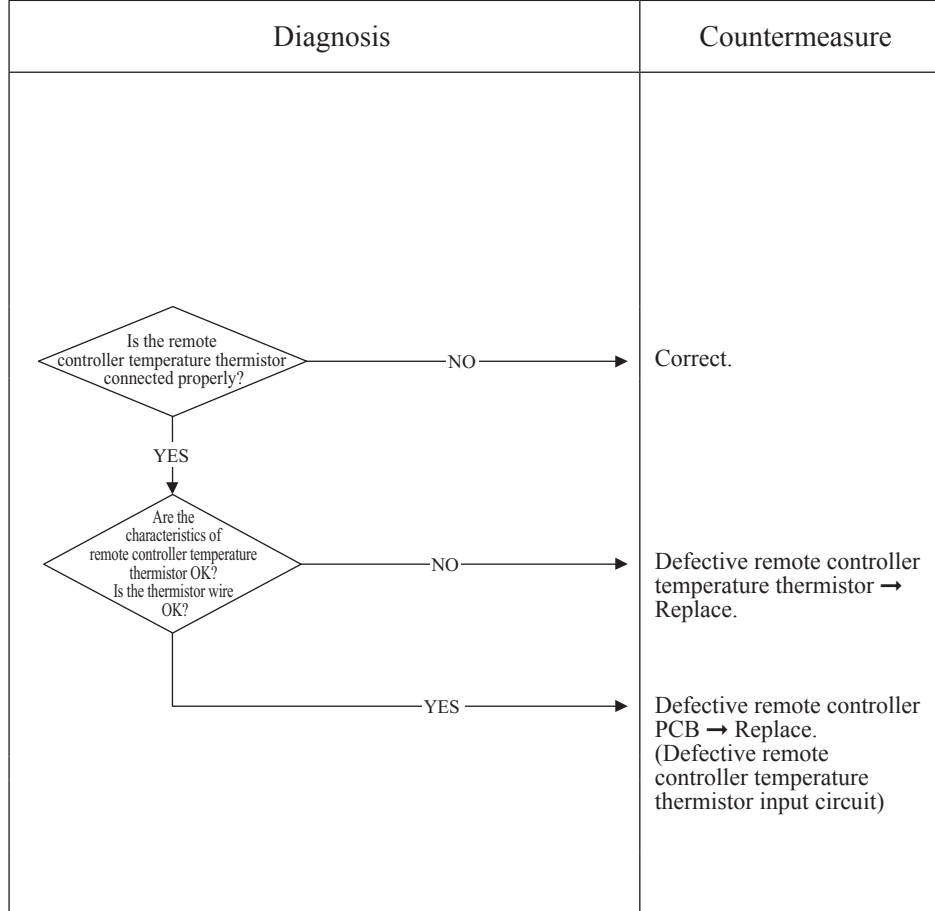

Resistance-temperature characteristics of remote controller temperature thermistor (ThC)

Temperature (°C)	Resistance value (kΩ)	Temperature (°C)	Resistance value (kΩ)
0	65	30	16
1	62	32	15
2	59	34	14
4	53	36	13
6	48	38	12
8	44	40	11
10	40	42	9.9
12	36	44	9.2
14	33	46	8.5
16	30	48	7.8
18	27	50	7.3
20	25	52	6.7
22	23	54	6.3
24	21	56	5.8
26	19	58	5.4
28	18	60	5.0

**Note:** After 10 seconds has passed since remote controller thermistor was switched from valid to invalid, E28 will not be displayed even if the thermistor harness is disconnected. At same time the thermistor, which is effective, is switched from remote controller thermistor to indoor return air temperature thermistor. Even though the remote controller thermistor is set to be Effective, the return air temperature displayed on remote controller for checking still shows the value detected by indoor return air temperature thermistor, not by remote controller temperature thermistor.

Error code Remote controller: E35	LED	Green	Red	Content <b>Cooling overload operation</b>
	Indoor	Keeps flashing	Stays OFF	
	Outdoor	—	2 times flash	

**1. Applicable model**  
All models

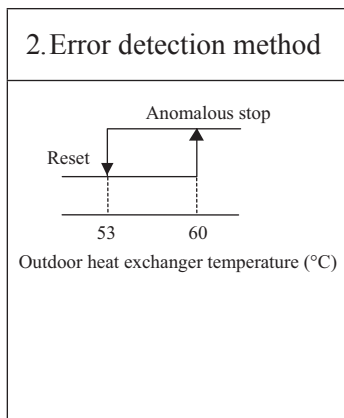

**3. Condition of Error displayed**  
When anomalous outdoor heat exchanger temperature occurs 5 times within 60 minutes or 60°C or higher continues for 10 minutes, including the compressor stop.

- 4. Presumable cause**
- Defective outdoor heat exchanger temperature sensor
  - Defective outdoor main PCB
  - Indoor, outdoor unit installation spaces
  - Short-circuit of air on indoor, outdoor units
  - Fouling, clogging of heat exchanger
  - Excessive refrigerant quantity

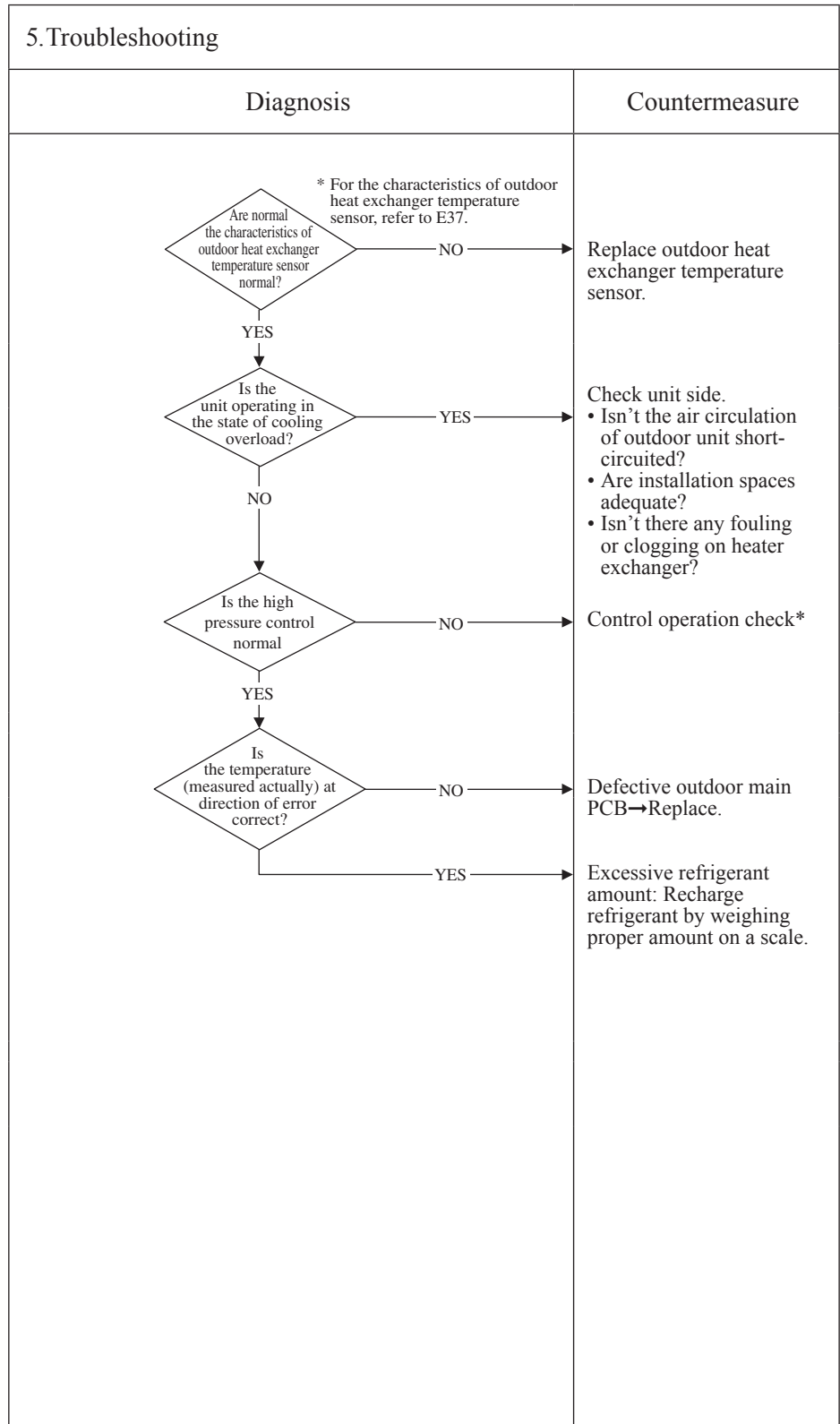

Note:

Error code Remote controller: E36	LED	Green	Red	Content <b>Discharge pipe temperature error</b>
	Indoor	Keeps flashing	Stays OFF	
	Outdoor	—	5 times flash	

<b>1. Applicable model</b>
All models

<b>2. Error detection method</b>
For the error detection method, refer to the protective control by controlling compressor rotation speed and cooling high pressure protective control of micro computer control function for corresponding models.

<b>3. Condition of Error displayed</b>
When discharge pipe temperature anomaly is detected 2 times within 60 minutes is compressor stop.

<b>4. Presumable cause</b>
<ul style="list-style-type: none"> <li>• Defective outdoor main PCB</li> <li>• Defective discharge pipe temperature sensor</li> <li>• Clogged filter</li> <li>• Indoor, outdoor unit installation spaces</li> <li>• Short-circuit of air on indoor, outdoor units</li> <li>• Fouling, clogging of heat exchanger</li> </ul>

<b>5. Troubleshooting</b>	
<b>Diagnosis</b>	<b>Countermeasure</b>
<p style="text-align: right;">* For the characteristics of discharge pipe temperature, refer to E39.</p> <pre> graph TD     D1{Are the characteristics of discharge pipe temperature sensor normal?}     D2{Is the discharge pipe temperature error persisted during cooling operation?}     D3{Is the discharge pipe temperature control normal?}     D4{Is the temperature (measured actually) at detection of error correct?}          D1 -- NO --&gt; C1[Replace discharge pipe temperature sensor.]     D1 -- YES --&gt; D2     D2 -- YES --&gt; C2[Insufficient refrigerant amount : Recharge refrigerant by weighing proper amount on a scale.]     D2 -- NO --&gt; D3     D3 -- NO --&gt; C3[Control operation check *]     D3 -- YES --&gt; D4     D4 -- NO --&gt; C4[Defective outdoor main PCB → Replace.]     D4 -- YES --&gt; C5[Check unit side: • Isn't filter clogged? • Are adequate indoor, outdoor unit installation spaces? • Isn't there any short-circuit of air? • Isn't there any fouling, clogging on indoor heat exchanger?]     </pre> <p style="text-align: center;">* For the contents of control, refer to the protective control by controlling compressor rotation speed and cooling high pressure protective control of micro computer control function for corresponding models.</p>	

Note:

Error code Remote controller: E37	LED	Green	Red	Content <b>Outdoor heat exchanger temperature sensor anomaly</b>
	Indoor	Keeps flashing	Stays OFF	
	Outdoor	—	8 times flash	

**1. Applicable model**  
All models

**2. Error detection method**  
Detection of anomalously low temperature (resistance) on the outdoor heat exchanger temperature sensor

**3. Condition of Error displayed**

- When the temperature sensor detects -55 °C or lower for 20 seconds continuously within 2 minutes to 2 minutes 20 seconds after the compressor ON, the compressor stops. After 3-minutes delay, the compressor starts again automatically, but if this anomalous temperature is detected 3 times within 40 minutes.
- When -55 °C or lower is detected for within 20 second after power ON.

**4. Presumable cause**

- Defective outdoor main PCB
- Broken sensor harness or temperature sensing section
- Disconnected wire connection (connector)

**5. Troubleshooting**

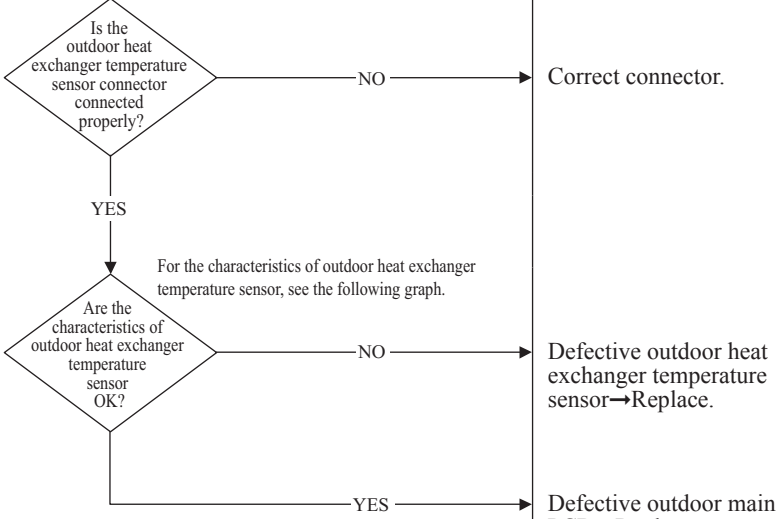
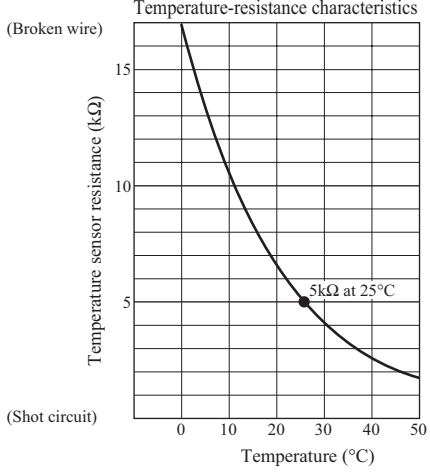
Diagnosis	Countermeasure
 <pre> graph TD     Q1{Is the outdoor heat exchanger temperature sensor connector connected properly?}     Q2{Are the characteristics of outdoor heat exchanger temperature sensor OK?}     C1[Correct connector.]     C2[Defective outdoor heat exchanger temperature sensor -&gt; Replace.]     C3[Defective outdoor main PCB -&gt; Replace. (Defective outdoor heat exchanger temperature sensor input circuit)]      Q1 -- NO --&gt; C1     Q1 -- YES --&gt; Q2     Q2 -- NO --&gt; C2     Q2 -- YES --&gt; C3                     </pre>	
<p>Temperature-resistance characteristics</p>  <p>(Broken wire)</p> <p>(Shot circuit)</p>	

Note:

Error code Remote controller: E38	LED	Green	Red	Content <b>Outdoor air temperature sensor anomaly</b>
	Indoor	Keeps flashing	Stays OFF	
	Outdoor	—	8 times flash	

**1. Applicable model**  
All models

**2. Error detection method**  
Detection of anomalously low temperature (resistance) on outdoor air temperature sensor

**3. Condition of Error displayed**

- When the temperature sensor detects -55 °C or lower for 5 seconds continuously within 2 minutes to 2 minutes 20 seconds after the compressor ON, the compressor stops. After 3-minutes delay, the compressor starts again automatically, but if this anomalous temperature is detected 3 times within 40 minutes.
- When -55 °C or lower is detected for within 20 second after power ON.

**4. Presumable cause**

- Defective outdoor main PCB
- Broken sensor harness or temperature sensing section (Check molding.)
- Disconnected wire connection (connector)

**5. Troubleshooting**

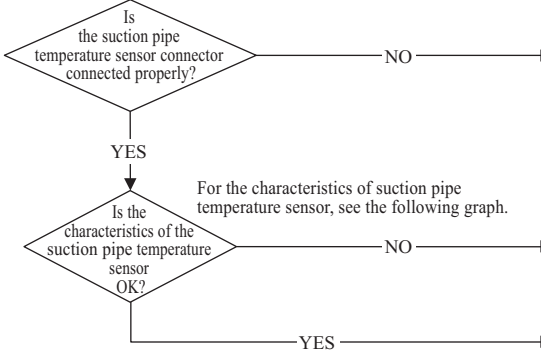
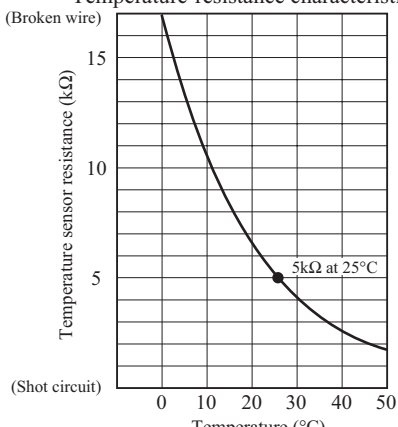
Diagnosis	Countermeasure
 <pre> graph TD     Q1{Is the suction pipe temperature sensor connector connected properly?} -- NO --&gt; C1[Correct connector.]     Q1 -- YES --&gt; Q2{Is the characteristics of the suction pipe temperature sensor OK?}     Q2 -- NO --&gt; C2[Defective outdoor air temperature sensor → Replace.]     Q2 -- YES --&gt; C3[Defective outdoor main PCB → Replace. (Defective outdoor air temperature sensor input circuit)]                     </pre>	
<p><b>Temperature-resistance characteristics</b></p> <p>(Broken wire)</p>  <p>(Shot circuit)</p>	

Note:

Error code Remote controller: E39	LED	Green	Red	Content <b>Discharge pipe temperature sensor anomaly</b>
	Indoor	Keeps flashing	Stays OFF	
	Outdoor	—	8 times flash	

**1. Applicable model**  
All models

**2. Error detection method**  
Detection of anomalously low temperature (resistance) on the discharge pipe temperature sensor

**3. Condition of Error displayed**  
When the temperature sensor detects -25 °C or lower for 5 seconds continuously within 10 minutes to 10 minutes 20 seconds after the compressor ON, the compressor stops. After 3-minutes delay, the compressor starts again automatically, but if this anomalous temperature is detected 3 times within 40 minutes.

**4. Presumable cause**

- Defective outdoor main PCB
- Broken sensor harness or temperature sensing section (Check molding.)
- Disconnected wire connection (connector)

**5. Troubleshooting**

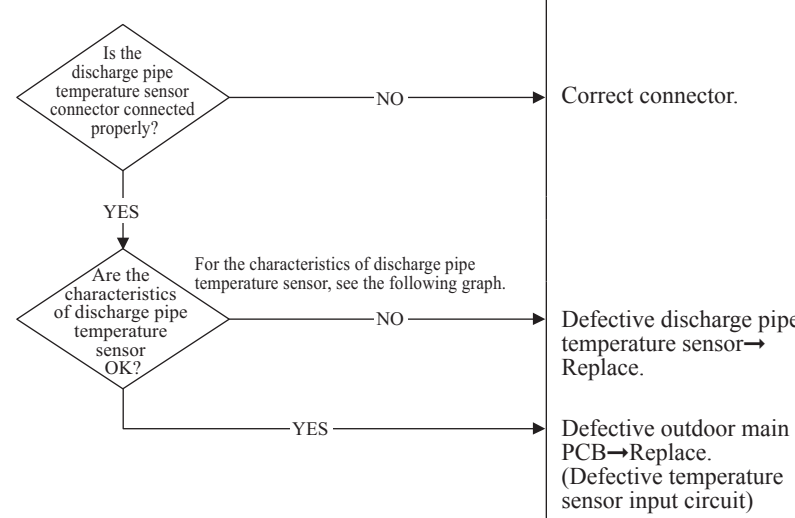
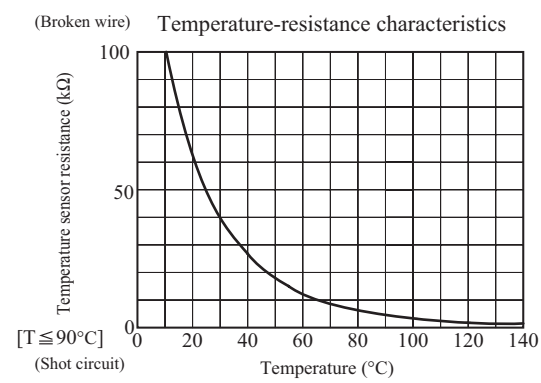
Diagnosis	Countermeasure
 <pre> graph TD     Q1{Is the discharge pipe temperature sensor connector connected properly?} -- NO --&gt; C1[Correct connector.]     Q1 -- YES --&gt; Q2{Are the characteristics of discharge pipe temperature sensor OK?}     Q2 -- NO --&gt; C2[Defective discharge pipe temperature sensor -&gt; Replace.]     Q2 -- YES --&gt; C3[Defective outdoor main PCB -&gt; Replace. (Defective temperature sensor input circuit)]                     </pre>	
<p>(Broken wire) Temperature-resistance characteristics</p> 	

Note:

Error code Remote controller: E42	LED	Green	Red	Content <b>Current cut (1/2)</b>
	Indoor	Keeps flashing	Stays OFF	
	Outdoor	–	1 time flash	

<b>1. Applicable model</b>
All models

<b>2. Error detection method</b>
In order to prevent from overcurrent of inverter, if the current exceeds the specifications, it makes the compressor stopping.

<b>3. Condition of Error displayed</b>
• If the output current of inveter exceeds the specifications, it makes the compressor stopping.

<b>4. Presumable cause</b>
<ul style="list-style-type: none"> <li>• The valves closed</li> <li>• Faulty power supply</li> <li>• Insufficient refrigerant amount</li> <li>• Faulty compressor</li> <li>• Faulty power transistor module</li> </ul>

<b>5. Troubleshooting</b>	
<b>Diagnosis</b>	<b>Countermeasure</b>
<pre> graph TD     D1{Is the Power supply voltage OK?} -- NO --&gt; C1[Check power supply.]     D1 -- YES --&gt; D2{Are the service valves opened?}     D2 -- NO --&gt; C2[Open the valves.]     D2 -- YES --&gt; D3{Is the high pressure during operation OK?}     D3 -- NO --&gt; C3[Check refrigerant amount and refrigerant circuit *In case of transitional increase of high pressure and/or test run, several times restarting may recover it, because liquid refrigerant (migrated) in the compressor is discharged from the compressor.]     D3 -- YES --&gt; D4{Is the checked result of insulation resistance and coil resistance (1) of compressor motor OK?}     D4 -- NO --&gt; C4[Replace compressor.]     D4 -- YES --&gt; C5[Continues to next page.]     </pre>	

Note:



Error code Remote controller: E42	LED	Green	Red	Content <b>Current cut (2/2)</b>
	Indoor	Keeps flashing	Stays OFF	
	Outdoor	–	1 time flash	

<b>1.Applicable model</b>
All models

<b>2.Error detection method</b>
In order to prevent from overcurrent of inverter, if the current exceeds the specifications, it makes the compressor stopping.

<b>3. Condition of Error displayed</b>
• If the output current of inverter exceeds the specifications, it makes the compressor stopping.

<b>4.Presumable cause</b>
<ul style="list-style-type: none"> <li>• Defective outdoor main PCB</li> <li>• Faulty power supply</li> <li>• Insufficient refrigerant amount</li> <li>• Faulty compressor</li> <li>• Faulty power transistor module</li> </ul>

<b>5.Troubleshooting</b>	
<b>Diagnosis</b>	<b>Countermeasure</b>
<p>Continue from previous page</p> <p>↓</p> <p>Is the checked result of power transistor module OK?</p> <p>NO → • Defective outdoor main PCB → Replace.</p> <p>YES ↓</p> <div style="border: 1px dashed black; padding: 5px;"> <ul style="list-style-type: none"> <li>• Is the space for installation of indoor and/or outdoor unit enough?</li> <li>• Is there any short circuit of air on indoor and/or outdoor unit?</li> <li>• At cooling, does the outdoor fan motor run? Are the service valves fully opened? Is the filter clogged?</li> <li>• At heating, does the indoor fan motor run? Are the service valves fully opened? Is the filter clogged?</li> <li>• Is there any liquid flooding? Is the superheat within normal range? Is the low pressure sensor and suction pipe temperature thermistor normal?</li> <li>• Is there any anomalous sound on the compressor?</li> </ul> </div> <p>YES ↓</p> <p>After resetting power for several times does it become normal?</p> <p>NO → • Defective outdoor main PCB → Replace.</p> <p>YES ↓</p> <div style="border: 1px solid black; padding: 5px;"> <p>Temporary noise may cause of anomaly. If noise source can be found, take countermeasure.</p> </div>	

Note:

<b>Error code</b> Remote controller: E45	<b>LED</b>	<b>Green</b>	<b>Red</b>	<b>Content</b> <h2 style="text-align: center;">Outdoor sub PCB communication error</h2>
	Indoor	Keeps flashing	Stays OFF	
	Outdoor	-	4 times flash	

<b>1. Applicable model</b>
All models

<b>2. Error detection method</b>
Detected communication error of more than 15 seconds 4 times in 15 minutes.

<b>3. Condition of Error displayed</b>
When communication is not established between the outdoor sub PCB and the outdoor main PCB.

<b>4. Presumable cause</b>
<ul style="list-style-type: none"> <li>• Defective sub PCB</li> <li>• Defective connector between the outdoor main PCB and outdoor sub PCB</li> <li>• Defective outdoor main PCB</li> </ul>

<b>5. Troubleshooting</b>	
<b>Diagnosis</b>	<b>Countermeasure</b>
<pre>                 graph TD                     D1{Is the connector connection between the outdoor main PCB and the outdoor sub PCB OK?}                     D2{Is the power supply voltage OK?}                     D3{Is the communication wire between the main PCB and the outdoor sub PCB connected properly?}                     P1[Replace the outdoor main PCB.]                     D4{Is normal state restored?}                      D1 -- NO --&gt; C1[Correct connector.]                     D1 -- YES --&gt; D2                     D2 -- NO --&gt; C2[Check why power is not supplied to outdoor sub PCB.]                     D2 -- YES --&gt; D3                     D3 -- NO --&gt; C3[Connect communication wire securely.]                     D3 -- YES --&gt; P1                     P1 --&gt; D4                     D4 -- NO --&gt; C4[Defective outdoor sub PCB -&gt; Replace.]                     D4 -- YES --&gt; C5[Malfunction by temporary noise]             </pre>	

Note:

Error code Remote controller: E47	LED	Green	Red	Content <b>Active filter voltage error</b>
	Indoor	Keeps flashing	Stays OFF	
	Outdoor	–	2 times flash	

<b>1. Applicable model</b>
All models

<b>2. Error detection method</b>
Error is displayed if the converter voltage exceeds DC340V (3 times within 20 minutes). Remote controller may be set after 3 minutes delay.

<b>3. Condition of Error displayed</b>
Same as above

<b>4. Presumable cause</b>
<ul style="list-style-type: none"> <li>• Defective outdoor sub PCB</li> <li>• Dust on outdoor sub PCB</li> <li>• Anomalous power supply</li> </ul>

<b>5. Troubleshooting</b>	
<b>Diagnosis</b>	<b>Countermeasure</b>
<pre> graph TD     A{Is the power supply normal?} -- NO --&gt; B[Restore normal condition.]     A -- YES --&gt; C{Is voltage within the specified range?}     C -- NO --&gt; D[Restore normal condition.]     C -- YES --&gt; E{Check soldered surfaces on the outdoor sub PCB for foreign matter like dust, fouling, etc.}     E -- NO --&gt; F[Remove foreign matter like dust, fouling, etc.]     E -- YES --&gt; G[Defective outdoor sub PCB → Replace.]         </pre>	

Note:

Error code Remote controller: E48	LED	Green	Red	Content <b>Outdoor fan motor anomaly</b>
	Indoor	Keeps flashing	Stays OFF	
	Outdoor	—	Keeps flashing	

<b>1. Applicable model</b>
All models

<b>2. Error detection method</b>
Detected by rotation speed of outdoor fan motor

<b>3. Condition of Error displayed</b>
When actual rotation speed of outdoor fan motor drops to 75min <sup>-1</sup> or lower for 30 minutes continuously, the compressor and the outdoor fan motor stop. After 3-minutes delay, it starts again automatically, but if this anomaly occurs 3 times within 60 minutes after the initial detection.

<b>4. Presumable cause</b>
<ul style="list-style-type: none"> <li>• Defective outdoor main PCB</li> <li>• Foreign material at rotational area of fan propeller</li> <li>• Defective fan motor</li> <li>• Dust on outdoor main PCB</li> <li>• Blown F3 fuse</li> </ul>

<b>5. Troubleshooting</b>	
<b>Diagnosis</b>	<b>Countermeasure</b>
<pre> graph TD     D1{Does any foreign material intervene in rotational area of fan propeller?} -- YES --&gt; C1[Remove foreign matter.]     D1 -- NO --&gt; D2{Does the fan rotate smoothly when turned by hand?}     D2 -- YES --&gt; D3{Is DC308-336V detected between (CNFAN ④ (blue)-⑤ (red)) of fan motor connector?}     D2 -- NO --&gt; C2[Replace fan motor. If resistance between ① (Vm):white -④(GND):blue is detected 1kΩ or lower, it is faulty.]     D3 -- YES --&gt; R1[Power supply reset]     D3 -- NO --&gt; D4{Is F3 (250V1A) fuse blown?}     R1 --&gt; D5{Is normal state restored?}     D4 -- YES --&gt; C3[Replace faulty fan motor and outdoor main PCB.]     D4 -- NO --&gt; C4[Check power supply voltage.]     D5 -- YES --&gt; C5[Malfunction by temporary noise]     D5 -- NO --&gt; C6[Replace fan motor (If anomaly persists after replacing fan motor, replace outdoor main PCB.)]     </pre>	

Note: When E48 error occurs, in almost cases F3 fuse (1A) on the outdoor main PCB is blown. There are a lot of cases that fuse is blown and E48 occurs due to defective fan motor. And even though only the outdoor main PCB ( or fuse) is replaced, another trouble could occur. Therefore when fuse is blown, check whether the fan motor is OK or not. After confirming the fan motor normal, check by power ON. (Don't power ON without confirming the fan motor normal.)

Error code Remote controller: E51	LED	Green	Red	Content <b>Power transistor anomaly</b>
	Indoor	Keeps flashing	Stays OFF	
	Outdoor	—	1 time flash	

<b>1.Applicable model</b>
All models

<b>2. Error detection method</b>
Power transistor primary current

<b>3. Condition of Error displayed</b>
If the power transistor primary current exceeds the setting value for 3 seconds, the compressor stops.

<b>4. Presumable cause</b>
<ul style="list-style-type: none"> <li>• Faulty outdoor main PCB</li> <li>• Dust on outdoor main PCB</li> <li>• Blown F2 fuse</li> </ul>

<b>5. Troubleshooting</b>	
<b>Diagnosis</b>	<b>Countermeasure</b>
<pre> graph TD     A{Check soldered surfaces on the outdoor main PCB for foreign matter like dust, fouling, etc.} -- NO --&gt; B[Remove foreign matter like dust, fouling, etc.]     A -- YES --&gt; C{Isn't F2 fuse (250V, 20A) blown?}     C -- YES --&gt; D[Replace fuse.]     C -- NO --&gt; E[Defective outdoor main PCB -&gt; Replace.]             </pre>	

Note:

Error code Remote controller: E53	LED	Green	Red	Content <b>Suction pipe temperature sensor anomaly</b>
	Indoor	Keeps flashing	Stays OFF	
	Outdoor	—	8 times flash	

**1. Applicable model**  
All models

**2. Error detection method**  
Detection of anomalously low temperature (resistance) on suction pipe temperature sensor

**3. Condition of Error displayed**

- When the temperature sensor detects -55 °C or lower for 5 seconds continuously within 2 minutes to 2 minutes 20 seconds after the compressor ON, the compressor stops. After 3-minutes delay, the compressor starts again automatically, but if this anomalous temperature is detected 3 times within 40 minutes.
- When -55 °C or lower is detected for within 20 second after power ON.

**4. Presumable cause**

- Defective outdoor sub PCB
- Broken sensor harness or temperature sensing section (Check molding.)
- Disconnected wire connection (connector)

**5. Troubleshooting**

Diagnosis	Countermeasure																
<pre> graph TD     Q1{Is the suction pipe temperature sensor connector connected properly?} -- NO --&gt; C1[Correct connector.]     Q1 -- YES --&gt; Q2{Is the characteristics of the suction pipe temperature sensor OK?}     Q2 -- NO --&gt; C2[Defective suction pipe temperature sensor → Replace.]     Q2 -- YES --&gt; C3[Defective outdoor sub PCB → Replace. (Defective suction pipe temperature sensor input circuit)]                     </pre>																	
<p><b>Temperature-resistance characteristics</b></p> <p>(Broken wire) at 0°C (Shot circuit) at 50°C</p> <table border="1"> <caption>Approximate data from Temperature-resistance characteristics graph</caption> <thead> <tr> <th>Temperature (°C)</th> <th>Temperature sensor resistance (kΩ)</th> </tr> </thead> <tbody> <tr><td>0</td><td>15</td></tr> <tr><td>10</td><td>10</td></tr> <tr><td>20</td><td>6</td></tr> <tr><td>25</td><td>5</td></tr> <tr><td>30</td><td>4</td></tr> <tr><td>40</td><td>3</td></tr> <tr><td>50</td><td>2</td></tr> </tbody> </table>	Temperature (°C)	Temperature sensor resistance (kΩ)	0	15	10	10	20	6	25	5	30	4	40	3	50	2	
Temperature (°C)	Temperature sensor resistance (kΩ)																
0	15																
10	10																
20	6																
25	5																
30	4																
40	3																
50	2																

Note:

Error code Remote controller: E57	LED	Green	Red	Content <b>Insufficient refrigerant amount or detection of service valve closure</b>
	Indoor	Keeps flashing	Stays OFF	
	Outdoor	—	2 times flash	

**1. Applicable model**  
All models

**2. Error detection method**  
• Judge insufficient refrigerant amount by detecting the temperature difference between indoor heat exchanger (ThI-R) and indoor return air (ThI-A).

**3. Condition of Error displayed**  
When the insufficient refrigerant amount is detected 3 times within 60 minutes.

**4. Presumable cause**  
• Defective indoor heat exchanger temperature thermistor  
• Defective indoor return air temperature thermistor  
• Defective indoor control PCB  
• Insufficient refrigerant amount

**5. Troubleshooting**

Diagnosis	Countermeasure
<p>Is the service valve fully opened?</p> <p>NO →</p> <p>YES ↓</p> <p>Are the connections of indoor heat exchanger and/or return air temperature thermistor connectors OK?</p> <p>NO →</p> <p>YES ↓</p> <p>Are the characteristics of indoor heat exchanger and/or return air temperature thermistor OK?</p> <p>NO →</p> <p>YES ↓</p> <p>Is the low pressure during operation normal?</p> <p>NO →</p> <p>YES →</p>	<p>Open fully.</p> <p>Correct indoor heat exchanger, return air temperature thermistor connector connections.</p> <p>Defective indoor heat exchanger, return air temperature thermistor → Replace.</p> <p>Charge refrigerant.</p> <p>Defective indoor control PCB → Replace. (Defective indoor heat exchanger, return air temperature thermistor input circuits)</p>

Indoor heat exchanger, return air temperature thermistor Temperature-resistance characteristics

(Broken wire)

(Shot circuit)

Note: When the compressor speed is 50 rps or under at 5 minutes after the start of compressor or the completion of defrosting, the low refrigerant protection control judges, by detecting the difference between the indoor heat exchanger temperature (ThI-R) and the indoor return air temperature (ThI-A), that it is in the state of gas low, and stops the compressor.  
Cooling: Indoor return air temperature (ThI-A) – Indoor heat exchanger temperature (ThI-R) ≥ 4 deg  
Heating: Indoor heat exchanger temperature (ThI-R) – Indoor return air temperature (ThI-A) ≤ 6 deg

Error code Remote controller: E58	LED	Green	Red	Content <b>Current safe stop</b>
	Indoor	Keeps flashing	Stays OFF	
	Outdoor	—	3 times flash	

<b>1.Applicable model</b>
All models

<b>2.Error detection method</b>
When the current safe control has operated at the compressor speed of 30 rps or under:

<b>3.Condition of Error displayed</b>
Same as above

<b>4.Presumable cause</b>
<ul style="list-style-type: none"> <li>• Excessive refrigerant amount</li> <li>• Indoor,outdoor unit installation spaces</li> <li>• Faulty compressor</li> <li>• Defective outdoor air temp. sensor</li> <li>• Defective outdoor main PCB</li> </ul>

<b>5.Troubleshooting</b>	
<b>Diagnosis</b>	<b>Countermeasure</b>
<pre> graph TD     D1{Is the refrigerant amount normal?} -- NO --&gt; C1[Adjust the refrigerant amount properly.]     D1 -- YES --&gt; D2{Is outdoor ventilation condition good?}     D2 -- NO --&gt; C2[Secure space for inlet and outlet.]     D2 -- YES --&gt; D3{Inspect compressor}     D3 -- NO --&gt; C3[Replace compressor.]     D3 -- YES --&gt; D4{Inspect outdoor air temp. sensor}     D4 -- NO --&gt; C4[Replace sensor.]     D4 -- YES --&gt; C5[Defective outdoor main PCB -&gt; Replace. (Defective outdoor air temp. sensor input circuit)]     </pre>	

Note:



Error code Remote controller: E59	LED	Green	Red	Content <b>Compressor startup failure</b>
	Indoor	Keeps flashing	Stays OFF	
	Outdoor	—	2 times flash	

<b>1.Applicable model</b>
All models

<b>2.Error detection method</b>
If it fails to change over to the rotor detection operation of compressor motor

<b>3. Condition of Error displayed</b>
If compressor fails to startup for 42 times

<b>4. Presumable cause</b>
<ul style="list-style-type: none"> <li>Faulty outdoor fan motor</li> <li>Faulty outdoor main PCB</li> <li>Anomalous power supply voltage</li> <li>Improper refrigerant amount and refrigerant circuit</li> <li>Faulty compressor (Motor bearing)</li> </ul>

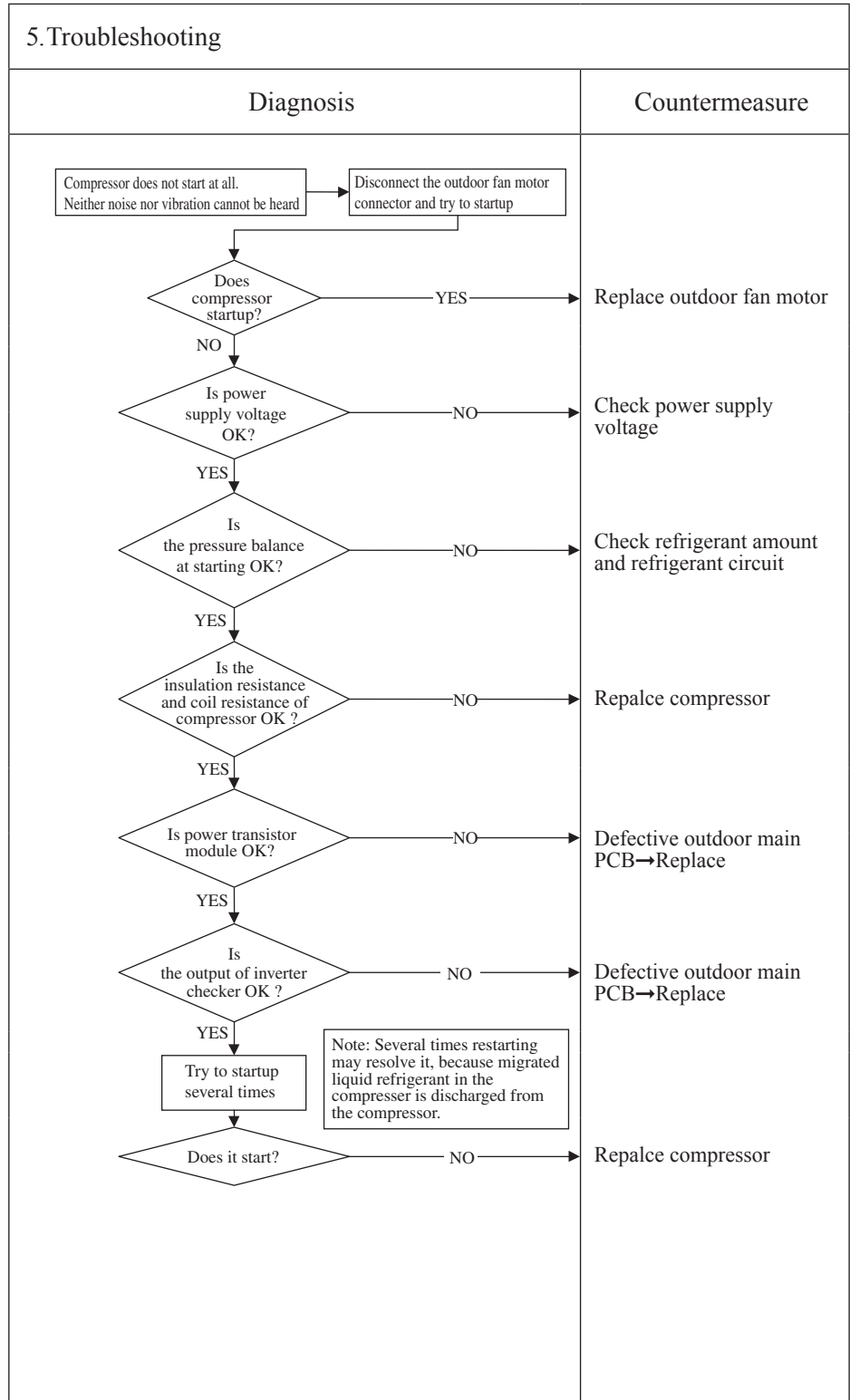

**Note: Insulation resistance**

- The unit is left for long period without power supply or soon after installation, migrated liquid refrigerant may dissolve in the refrigerant oil in the compressor. In such case insulation resistance decreases upto several MΩ or lower. If the electric leakage breaker is activated due to low insulation resistance, check followings.
  - ① Check whether the insulation resistance can recover or not, ater 6 hours has passed since power ON.  
(By energize the crankcase heater, migrated liquid refrigerant in the refrigerant oil in compressor can be evaporated)
  - ② Check whether the electric leakage breake conforms to high-hermonic specifications  
(As units has inverter, in order to prevent from improper operation, be sure to use high-hermonic one.)

Error code Remote controller: E60	LED	Green	Red	Content <b>Compressor rotor lock error</b>
	Indoor	Keeps flashing	Stays OFF	
	Outdoor	—	7 times flash	

<b>1. Applicable model</b>
All models
<b>2. Error detection method</b>
Compressor rotor position
<b>3. Condition of Error displayed</b>
If it fails again to detect the rotor position after shifting to the compressor rotor position detection operation, the compressor stops.
<b>4. Presumable cause</b>
<ul style="list-style-type: none"> <li>• Defective outdoor main PCB</li> <li>• Anomalous power supply voltage</li> <li>• Improper refrigerant amount and refrigerant circuit</li> <li>• Defective compressor (motor, bearing)</li> </ul>

<b>5. Troubleshooting</b>	
<b>Diagnosis</b>	<b>Countermeasure</b>
<pre> graph TD     Q1{Is the power supply voltage OK?} -- NO --&gt; C1[Check and correct the power supply voltage]     Q1 -- YES --&gt; R1[Reset the power supply and restart operation.]     R1 --&gt; Q2{Does the compressor start?}     Q2 -- NO --&gt; Q3{Does E59 occur?}     Q3 -- YES --&gt; C2[Correct it based on the troubleshooting of E59]     Q3 -- NO --&gt; Q4{Does the compressor run without occurrence of E42?}     Q4 -- NO --&gt; C3[Correct it based on the troubleshooting of E42]     Q2 -- YES --&gt; Q5{Is the output from inverter checker OK?}     Q5 -- NO --&gt; C4[Defective outdoor main PCB → Replace.]     Q5 -- YES --&gt; Q6{Is the noise or vibration of compressor normal?}     Q6 -- NO --&gt; C5[Replace compressor.]     Q6 -- YES --&gt; Q7{Does it start up normally without recurrence of E60.}     Q7 -- NO --&gt; C6[Check compressor for insulation, resistance. Replace compressor if necessary.]     Q7 -- YES --&gt; C7[Defective outdoor main PCB → Replace.]                     </pre>	

**Note: Insulation resistance**

- The unit is left for long period without power supply or soon after installation, migrated liquid refrigerant may dissolve in the refrigerant oil in the compressor. In such case insulation resistance decreases upto several MΩ or lower. If the electric leakage breaker is activated due to low insulation resistance, check followings.
  - ① Check whether the insulation resistance can recover or not, after 6 hours has passed since power ON.  
(By energize the crankcase heater, migrated liquid refrigerant in the refrigerant oil in compressor can be evaporated)
  - ② Check whether the electric leakage breaker conforms to high-harmonic specifications  
(As units has inverter, in order to prevent from improper operation, be sure to use high-harmonic one.)

### 3. ELECTRICAL WIRINGS

#### 3.1 Outdoor units

Models SCM40ZJ-S, 45ZJ-S

Всe каталоги и инструкции здесь: <http://splitoff.ru/ehd-doc.html>

Indication lamp	Color	Function
Led e (1)	Red	Warning lamp
Self diagnosis function by led e		
1 Time flash		Current cut
2 Time flash		Trouble of outdoor unit
3 Time flash		Over current
4 Time flash		Transmission error
5 Time flash		Over heat of compressor
6 Time flash		Error of signal transmission
7 Time flash		Lock of compressor
8 Time flash		Sensor error (Except discharge pipe sensor)
Light on		Outdoor fan motor error
Four sec light and four sec off		Discharge pipe sensor error
Caution • When the compressor does not run immediately hitting on the button, wait for 5 to 10 minutes. (The possibility of delayed start.)		
• High voltage is produced in the control box. do not touch electrical parts in the control box for 5 minutes after cutting power supply.		

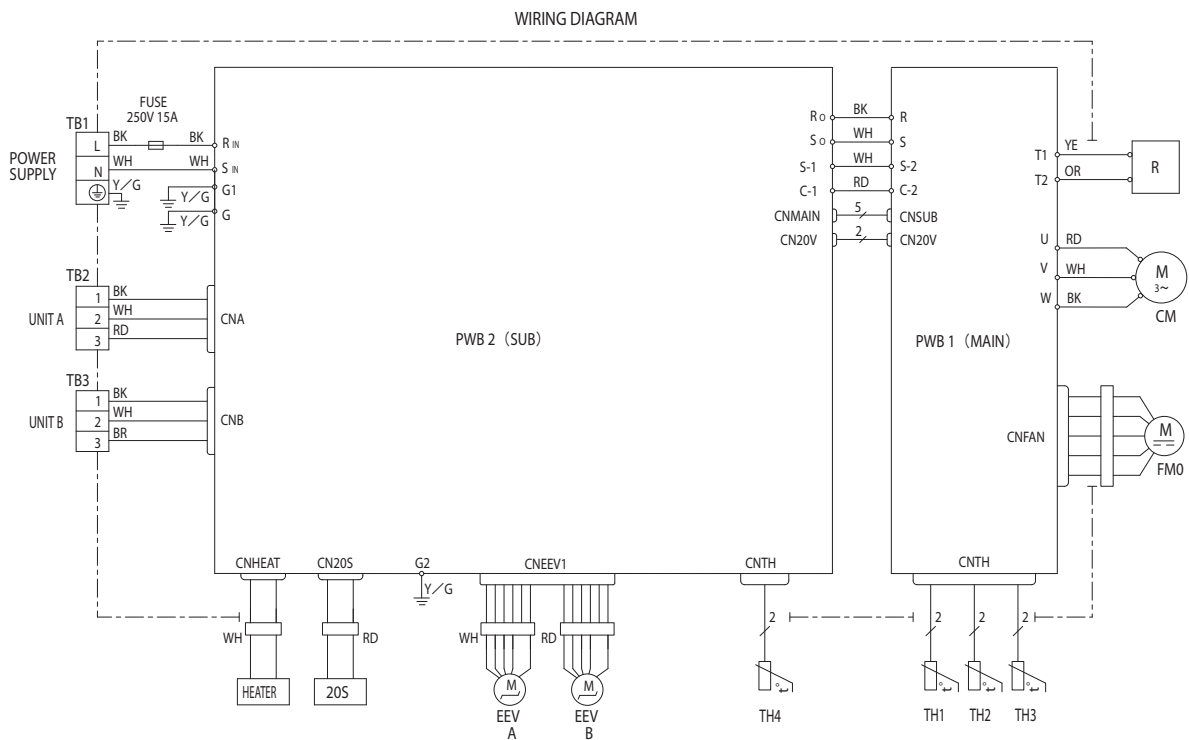

WIRING DIAGRAM

#### Color Marks

Mark	Color	Mark	Color
BK	Black	YE	Yellow
RD	Red	Y/G	Yellow/Green
WH	White		
OR	Orange		
BR	Brown		

#### Meaning of Marks

Item	Description	Item	Description
CNA-CN20S	Connector	R	Reactor
20S	4 Way valve (coil)	TB1-TB3	Terminal block
CM	Compressor motor	Th1	Heat exchanger sensor (outdoor unit)
EEV A, EEV B	Electric expansion valve (coil)	Th2	Outdoor air temp. sensor
FMo	Fan motor	Th3	Discharge pipe temp. sensor
HEATER	Crank case heater	Th4	Suction pipe temp. sensor

RWC000Z232



WIRING DIAGRAM

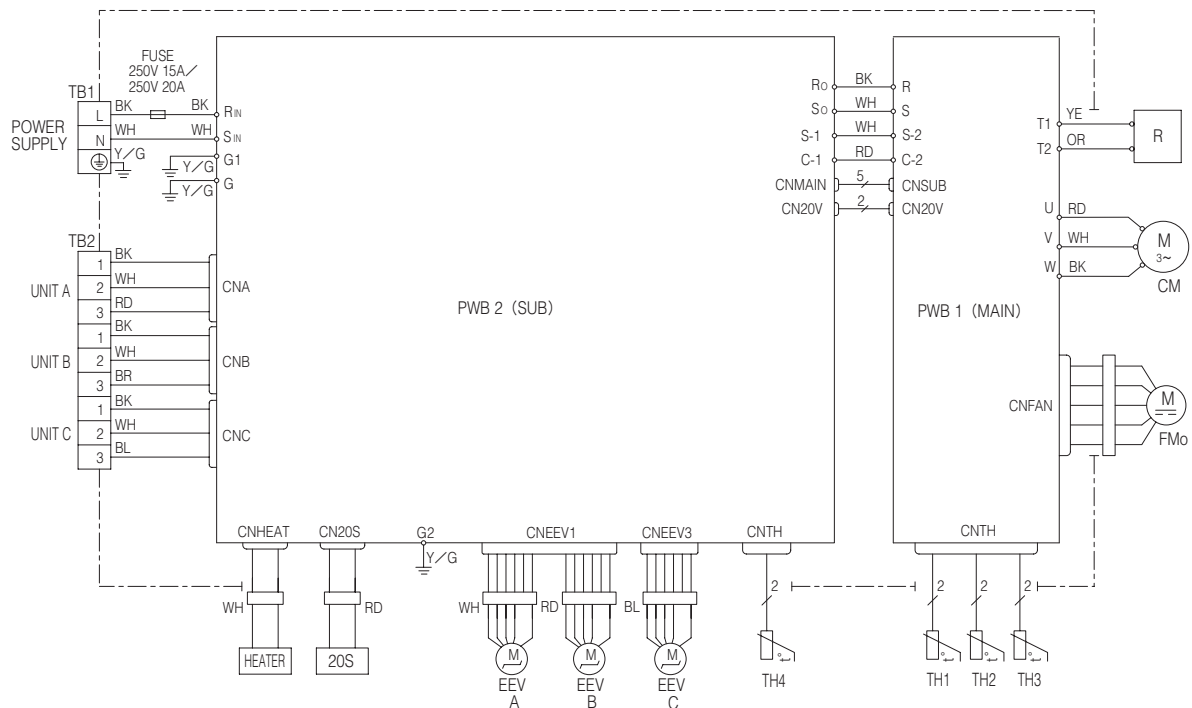

Indication lamp	Color	Function
Led e (1)	Red	Warning lamp
Self diagnosis function by led e		
1 Time flash	Current cut	
2 Time flash	Trouble of outdoor unit	
3 Time flash	Over current	
4 Time flash	Transmission error	
5 Time flash	Over heat of compressor	
6 Time flash	Error of signal transmission	
7 Time flash	Lock of compressor	
8 Time flash	Sensor error (Except discharge pipe sensor)	
Light on	Outdoor fan motor error	
Four sec light and four sec off	Discharge pipe sensor error	
Caution • When the compressor does not run immediately after hitting on the button, wait for 5 to 10 minutes. (There is possibility of delayed start.)		
• High voltage is produced in the control box. don't touch electrical parts in the control box for 5 minutes after cutting power supply.		

Color Marks

Mark	Color	Mark	Color
BK	Black	BR	Brown
BL	Blue	YE	Yellow
RD	Red	Y/G	Yellow/Green
WH	White		
OR	Orange		

Meaning of Marks

Item	Description	Item	Description
CNA-CN20S	Connector	R	Reactor
20S	4 Way valve (coil)	TB1, TB2	Terminal block
CM	Compressor motor	Th1	Heat exchanger sensor (outdoor unit)
EEV A, EEV B	Electric expansion valve (coil)	Th2	Outdoor air temp. sensor
EEV C		Th3	Discharge pipe temp. sensor
FMo	Fan motor	Th4	Suction pipe temp. sensor
HEATER	Crank case heater		

RWC000Z294

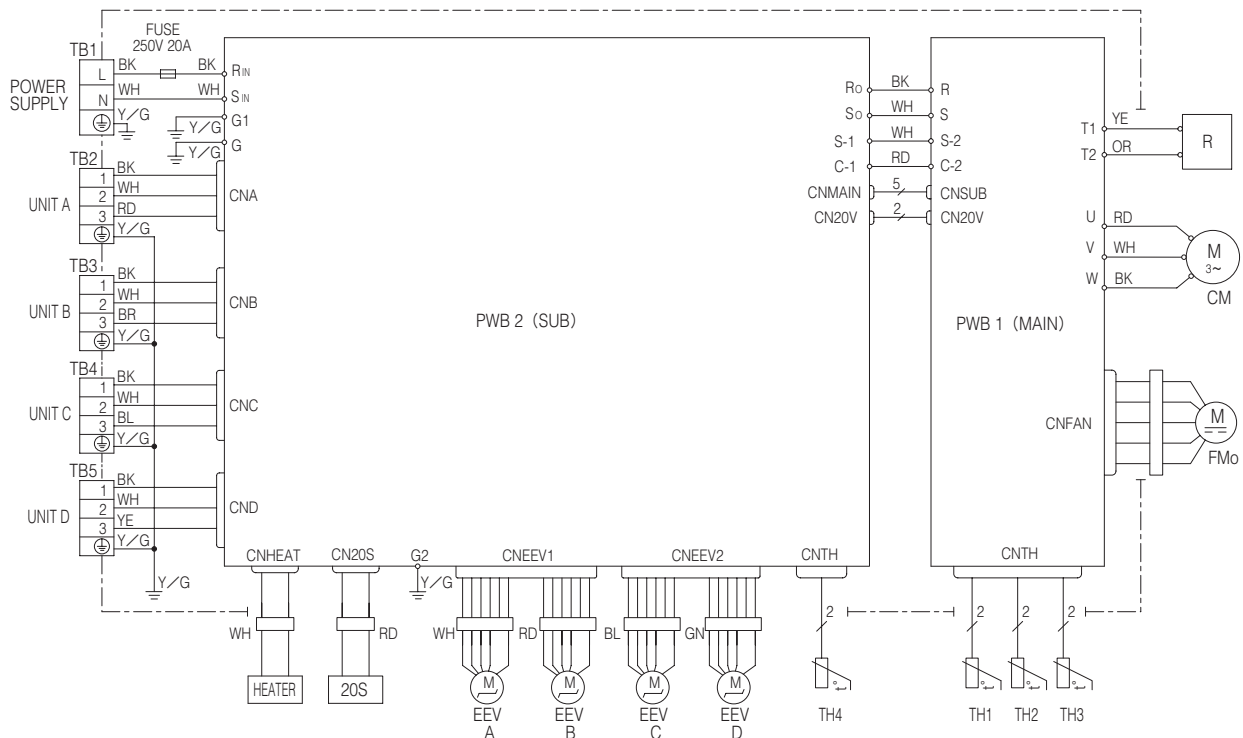

Indication lamp	Color	Function
Led e (1)	Red	Warning lamp
Self diagnosis function by led e		
1 Time flash		Current cut
2 Time flash		Trouble of outdoor unit
3 Time flash		Over current
4 Time flash		Transmission error
5 Time flash		Over heat of compressor
6 Time flash		Error of signal transmission
7 Time flash		Lock of compressor
8 Time flash		Sensor error (Except discharge pipe sensor)
Light on		Outdoor fan motor error
Four sec light and four sec off		Discharge pipe sensor
Caution • When the compressor does not run immediately after hitting on the button, wait for 5 to 10 seconds (There is possibility of delayed start.)  • High voltage is produced in the coil of electrical parts in the control box for 10 seconds after cutting power supply.		

Всё каталог и инструкции здесь: <http://splitoff.ru/ehh-doc.html>

Color Marks

Mark	Color	Mark	Color
BK	Black	RD	Red
BL	Blue	WH	White
BR	Brown	YE	Yellow
GN	Green	Y/G	Yellow/Green
OR	Orange		

Meaning of Marks

Item	Description	Item	Description
CNA-CN20S	Connector	R	Reactor
20S	4 Way valve (coil)	TB1~5	Terminal block
CM	Compressor motor	Th1	Heat exchanger sensor (outdoor unit)
EEV A,EEV B	Electric expansion valve (coil)	Th2	Outdoor air temp. sensor
EEV C,EEV D		Th3	Discharge pipe temp. sensor
FMo	Fan motor	Th4	Suction pipe temp. sensor
HEATER	Crank case heater		

RWA000Z227

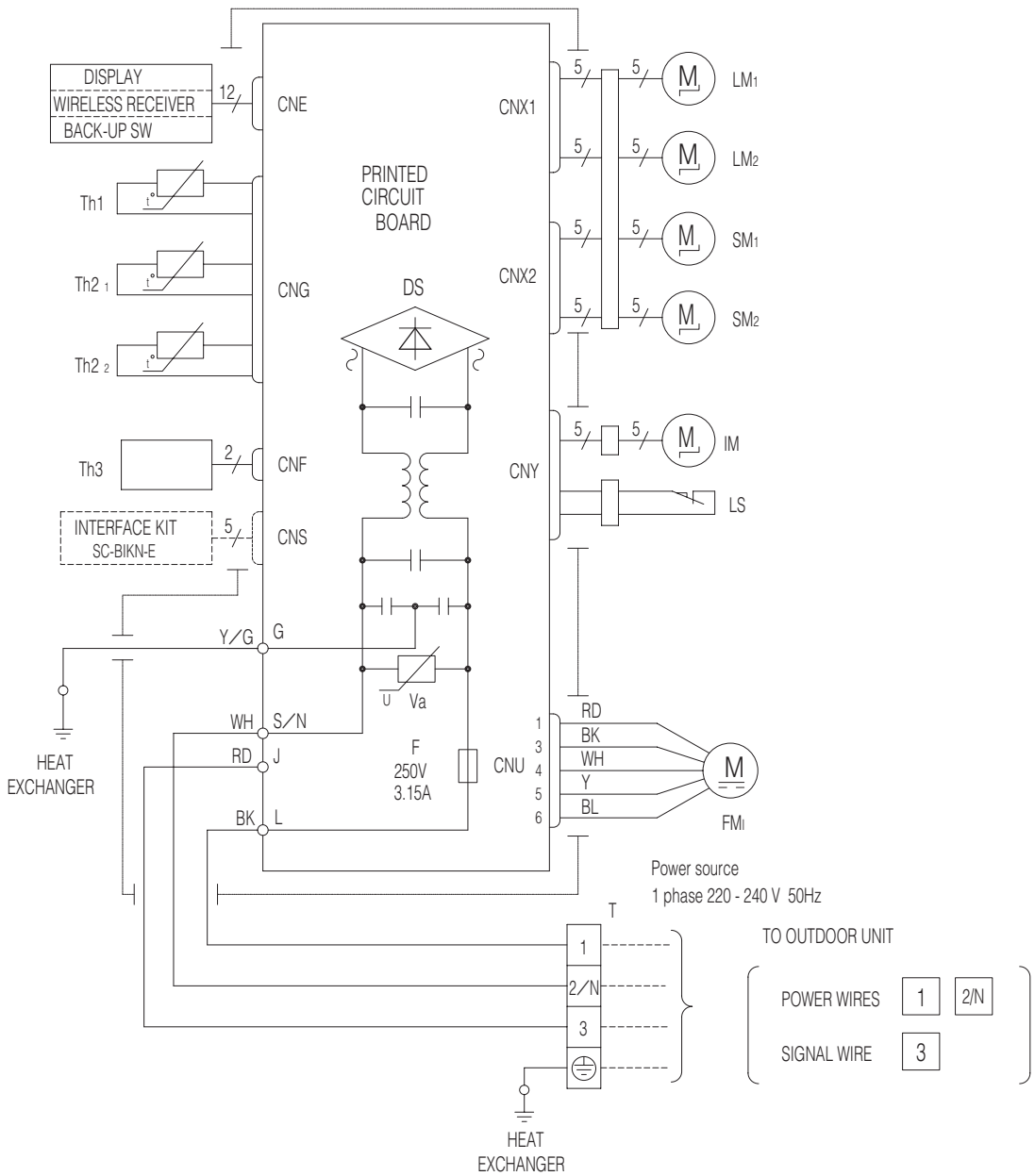

Item	Description
CNE-CNY	Connector
FM <sub>i</sub>	Fan motor
SM <sub>1,2</sub>	Flap motor
LM <sub>1,2</sub>	Louver motor
IM	Inlet motor
Th1	Room temp. sensor
Th2 <sub>1,2</sub>	Heat exch. sensor
Th3	Humidity sensor (50,60 only)
LS	Limit switch
DS	Diode stack
F	Fuse
T	Terminal block
Va	Varistor

Color Marks

Mark	Color
BK	Black
BL	Blue
RD	Red
WH	White
Y	Yellow
Y/G	Yellow/Green

3.2 Indoor units

(1) Wall mounted type (SRK)

Models SRK20ZJX-S, 25ZJX-S, 35ZJX-S, 50ZJX-S, 60ZJX-S

RWA000Z226

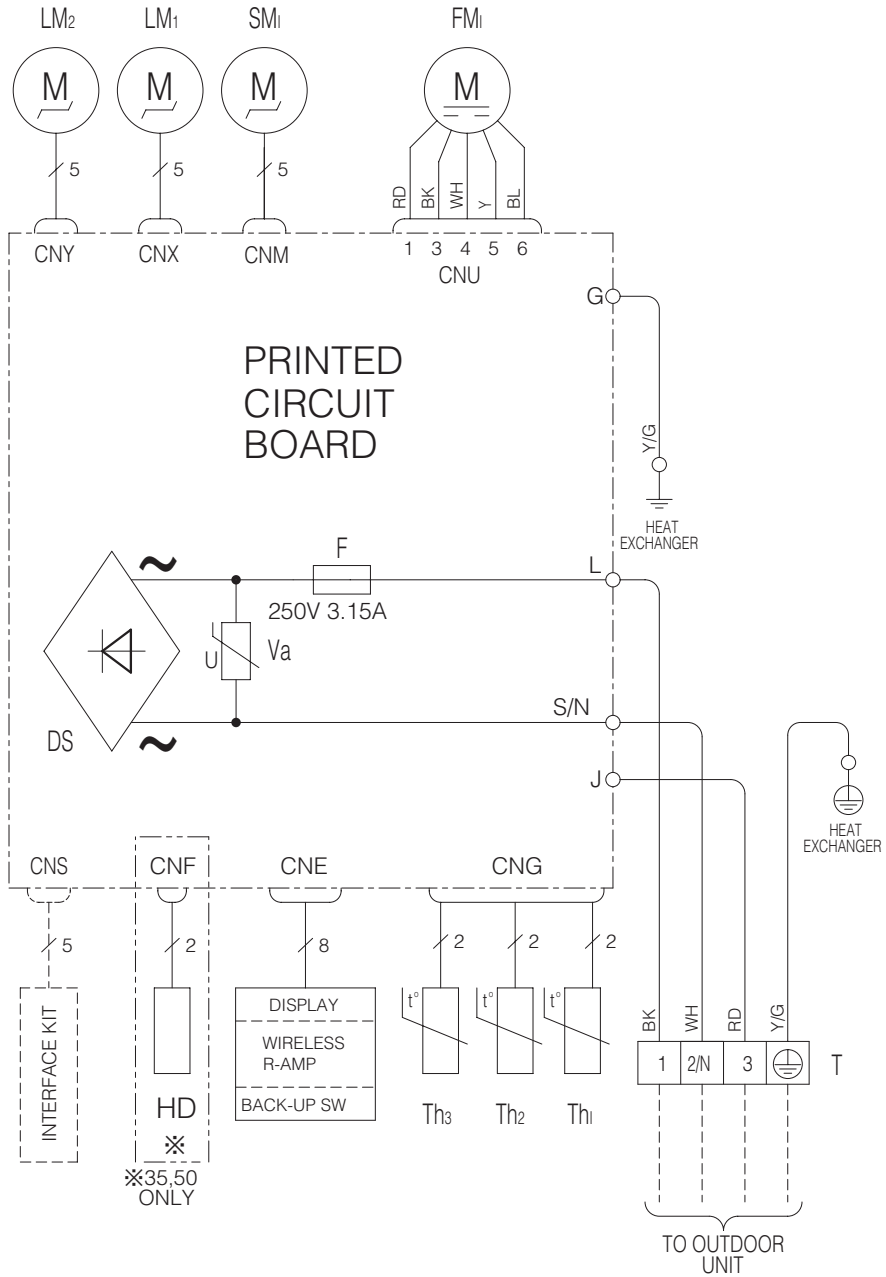

Power Source  
1 Phase  
220/230/240V 50Hz

Item	Description
CNE-CNY	Connector
FM <sub>1</sub>	Fan motor
SM <sub>1</sub>	Flap motor
LM <sub>1,2</sub>	Louver motor
HD	Humidity sensor
Th <sub>1</sub>	Room temp. sensor
Th <sub>2,3</sub>	Heat exch. sensor
DS	Diode stack
F	Fuse
T	Terminal block
Va	Varistor

Mark	Color
BK	Black
BL	Blue
RD	Red
WH	White
Y	Yellow
Y/G	Yellow/Green

Все каталоги и инструкции здесь: <http://splitoff.ru/ehp-doc.html>

Models SRK20ZJ-S, 25ZJ-S, 35ZJ-S, 50ZJ-S

RWB000Z052

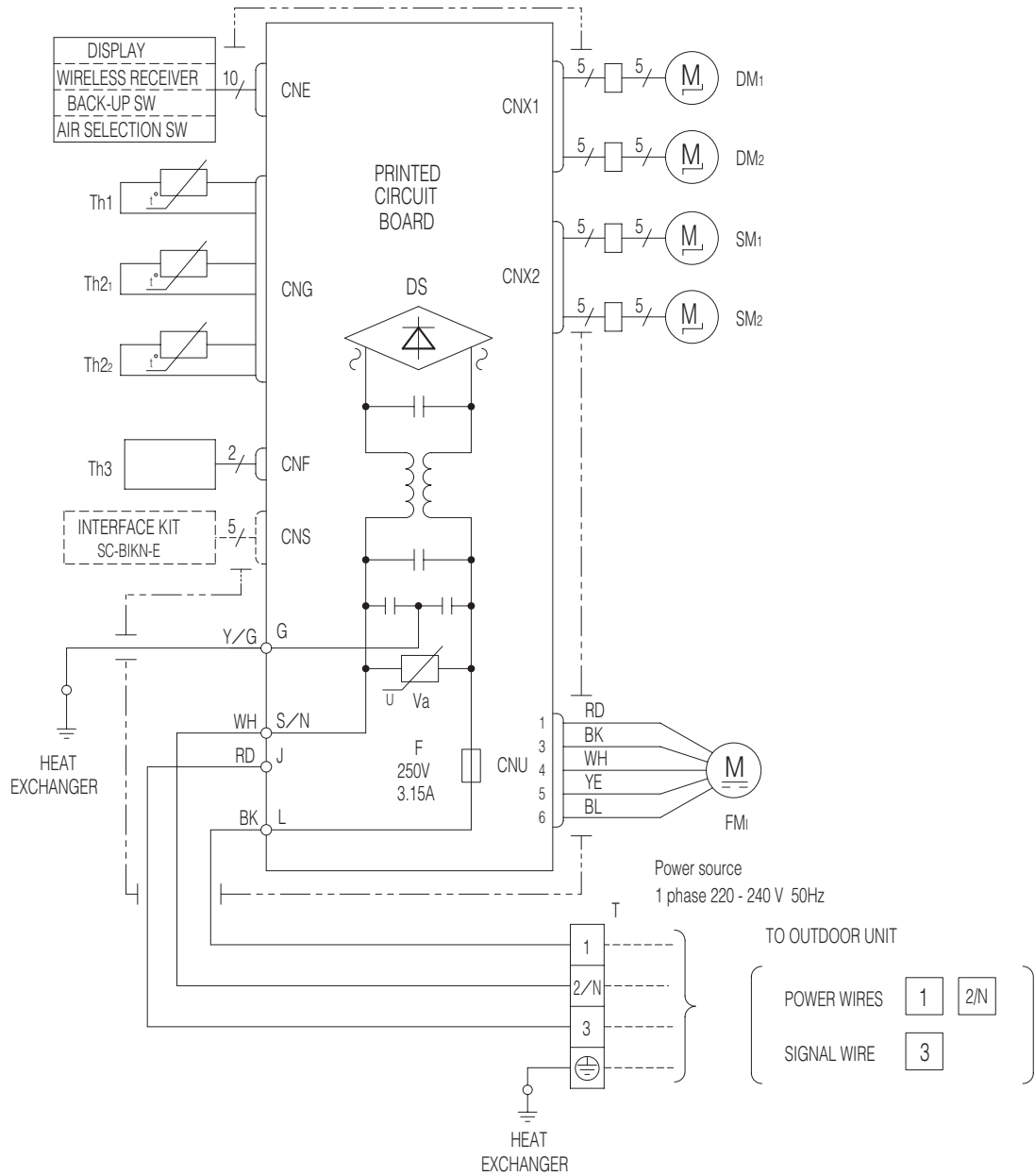

Item	Description
CNE-CN2	Connector
FM <sub>1</sub>	Fan motor
SM <sub>1,2</sub>	Flap motor
DM <sub>1</sub>	Damper motor
DM <sub>2</sub>	Damper arm motor
Th <sub>1</sub>	Room temp. sensor
Th <sub>2,1,2</sub>	Heat exch. sensor
Th <sub>3</sub>	Humidity sensor
DS	Diode stack
F	Fuse
T	Terminal block
Va	Varistor

Color Marks

Mark	Color
BK	Black
BL	Blue
RD	Red
WH	White
YE	Yellow
Y/G	Yellow/Green

(2) Floor standing type (SRF)  
Models SRF25ZJX-S, 35ZJX-S, 50ZJX-S



(3) Ceiling concealed type (SRR)  
 Models SRR25ZJ-S, 35ZJ-S, 50ZJ-S, 60ZJ-S

Все каталог и инструкции здесь: <http://splitoff.ru/ehh-doc.html>

Power source  
 1 phase 220 - 240 V 50  
 TO OUTDOOR UNIT  
 POWER WIRES  
 SIGNAL WIRE

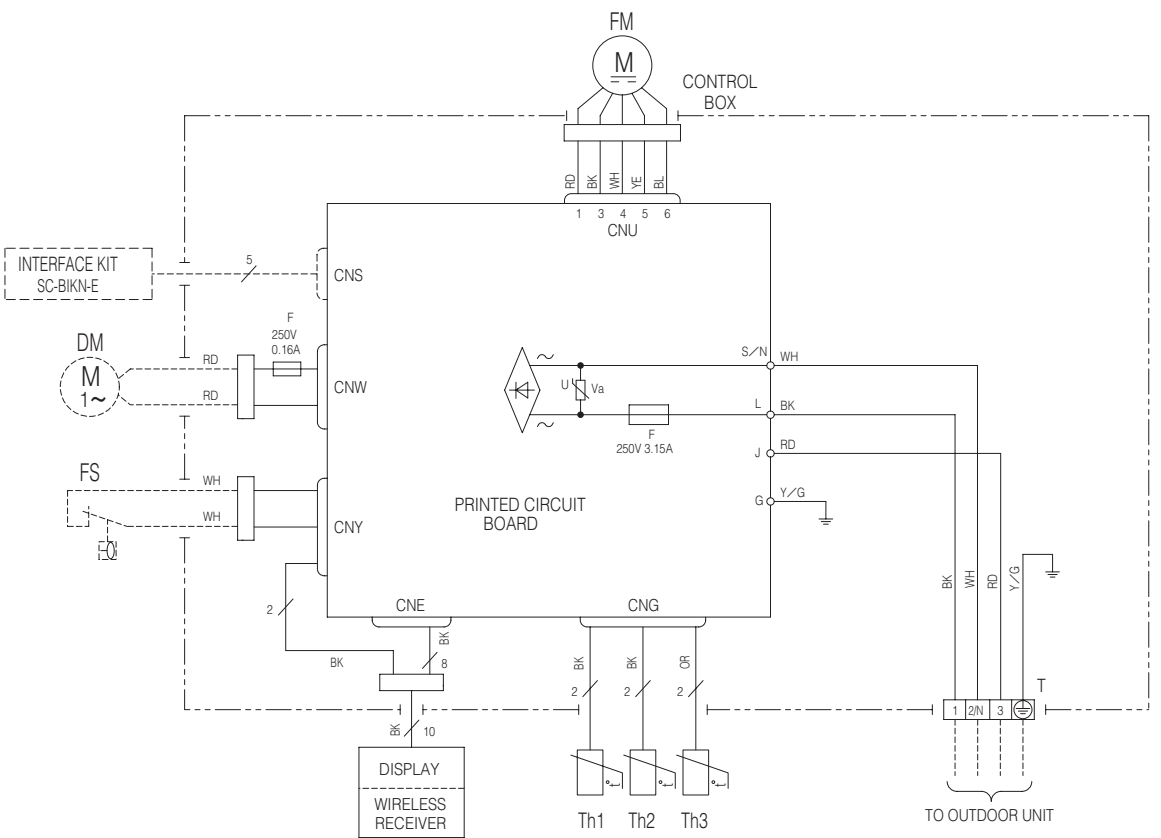

Color Marks

Mark	Color	Mark	Color
BK	Black	YE	Yellow
BL	Blue	Y/G	Yellow/Green
OR	Orange		
RD	Red		
WH	White		

Meaning of Marks

Item	Description	Item	Description
CNE-CNY	Connector	Th1	Room temp. sensor
F	Fuse	Th2	Heat exch. sensor 1
FM <sub>1</sub>	Fan motor	Th3	Heat exch. sensor 2
DM	Drain motor	T	Terminal block
FS	Float switch	Va	Varistor

PLA003Z340

CNB~Z	Connector
DM	Drain motor
F200~203	Fuse
FM i	Fan motor
FS	Float switch
LED-2	Indication lamp (Green-Normal operation)

LED-3	Indication lamp (Red-Inspection)
LM1~4	Louver motor
SW2	Remote controller communication address
SW5	Plural units Master / Slave setting
SW6	Model capacity setting
SW7-1	Operation check, Drain motor test run

TB1	Terminal block (Power source) (□ mark)
TB2	Terminal block (Signal line) (□ mark)
Thc	Thermistor (Remote controller)
Th-A	Thermistor (Return air)
Th-R1,2,3	Thermistor (Heat exchanger)
X4	Relay for DM
■ mark	Closed-end connector

Color Marks

Mark	Color
BK	Black
BL	Blue
BR	Brown
OR	Orange
RD	Red
WH	White
Y	Yellow
Y / GN	Yellow / Green

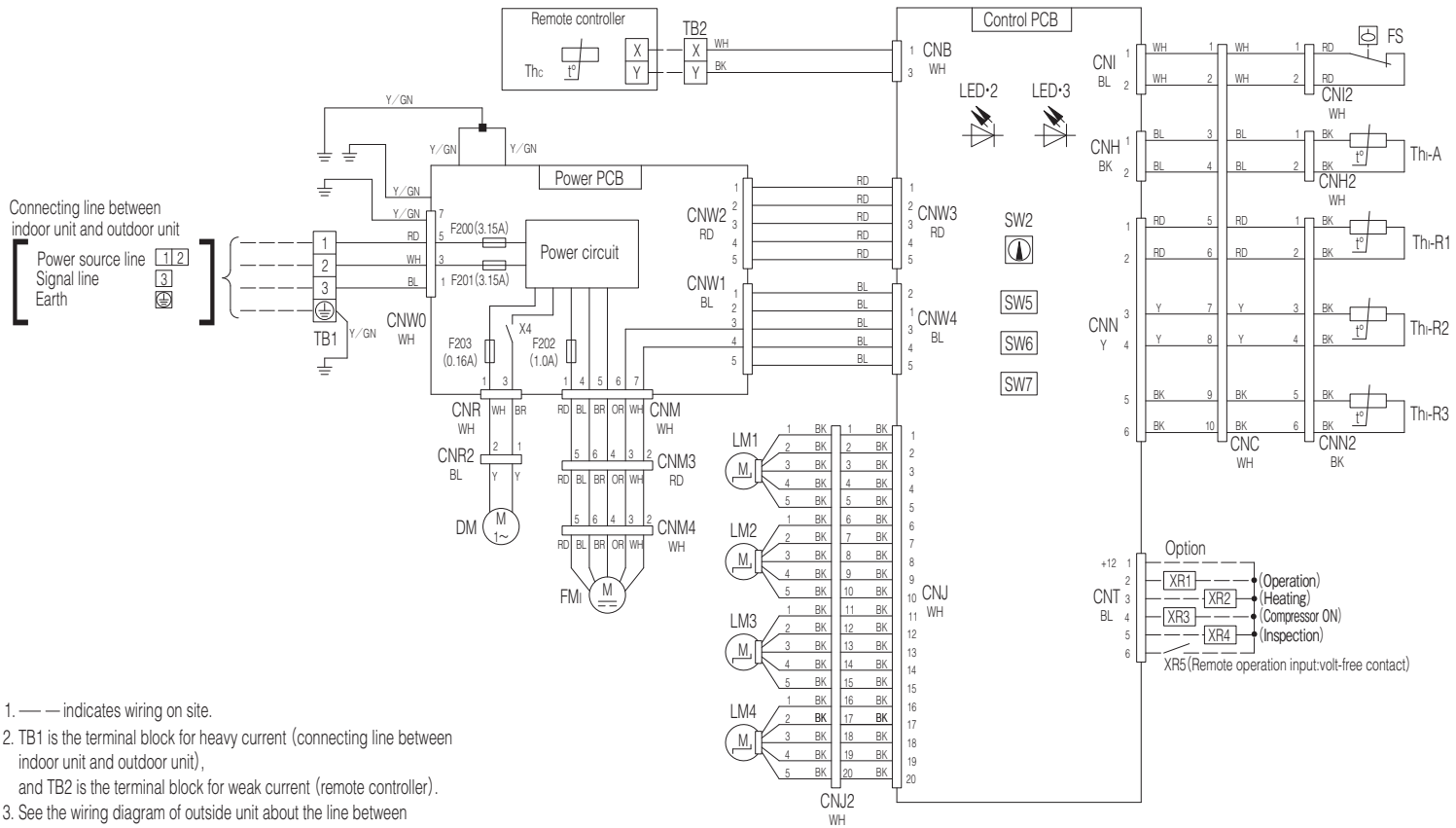

- Notes
1. — indicates wiring on site.
  2. TB1 is the terminal block for heavy current (connecting line between indoor unit and outdoor unit), and TB2 is the terminal block for weak current (remote controller).
  3. See the wiring diagram of outside unit about the line between inside unit and outside unit.
  4. Use twin core cable (0.3mm<sup>2</sup>X2) at remote controller line. See spec sheet of remote controller in case that the total length is more than 100m.
  5. Do not put remote controller line alongside power source line.

(4) Ceiling cassette-4way compact type (FDTC)  
Models FDTCSVD, 35VD, 50VD, 60VD

# 4. PIPING SYSTEMS

Models SCM40ZJ-S, 45ZJ-S

Всe каталоги и инструкции здесь: <http://splitoff.ru/ehh-doc.html>

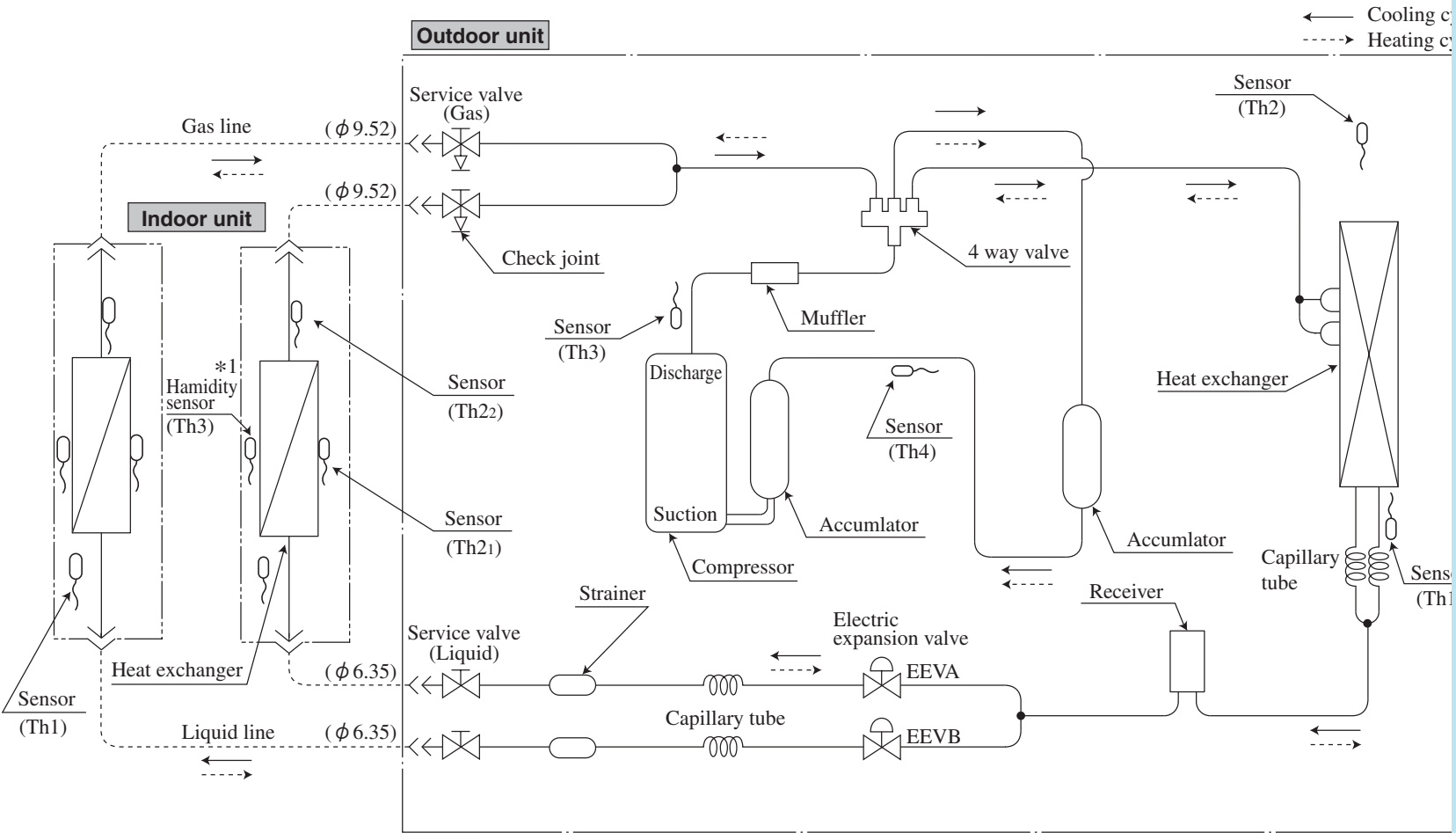

\*1 Humidity sensor  
SRK35ZJ-S and SRF series only.

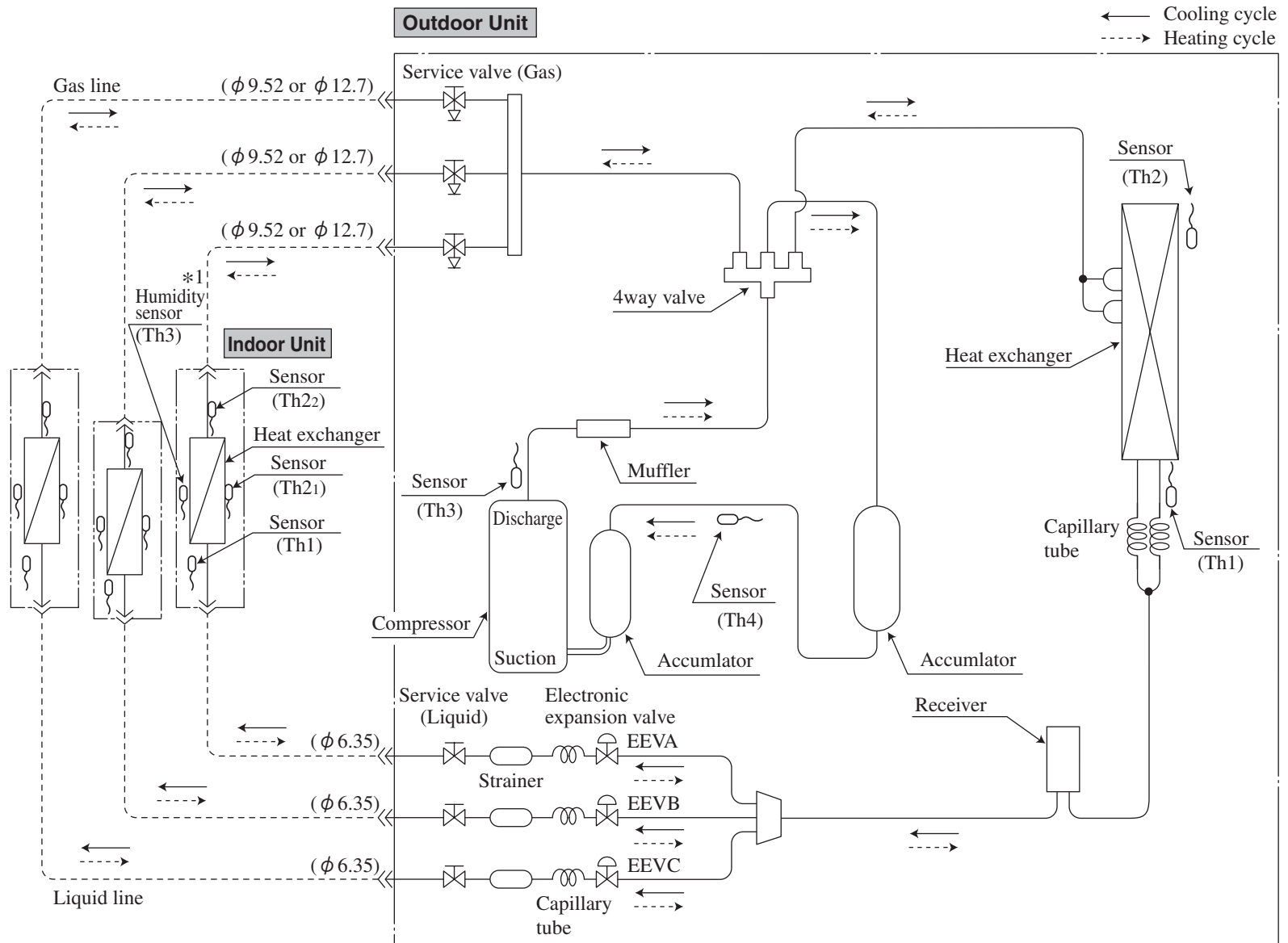

Gas line  
 Model 20, 25, 35 :  $\phi$  9.52  
 Model 50, 60 :  $\phi$  12.7

\*1 Humidity sensor  
 SRK50, 60ZJX-S, SRK35, 50ZJ-S and SRF series only.

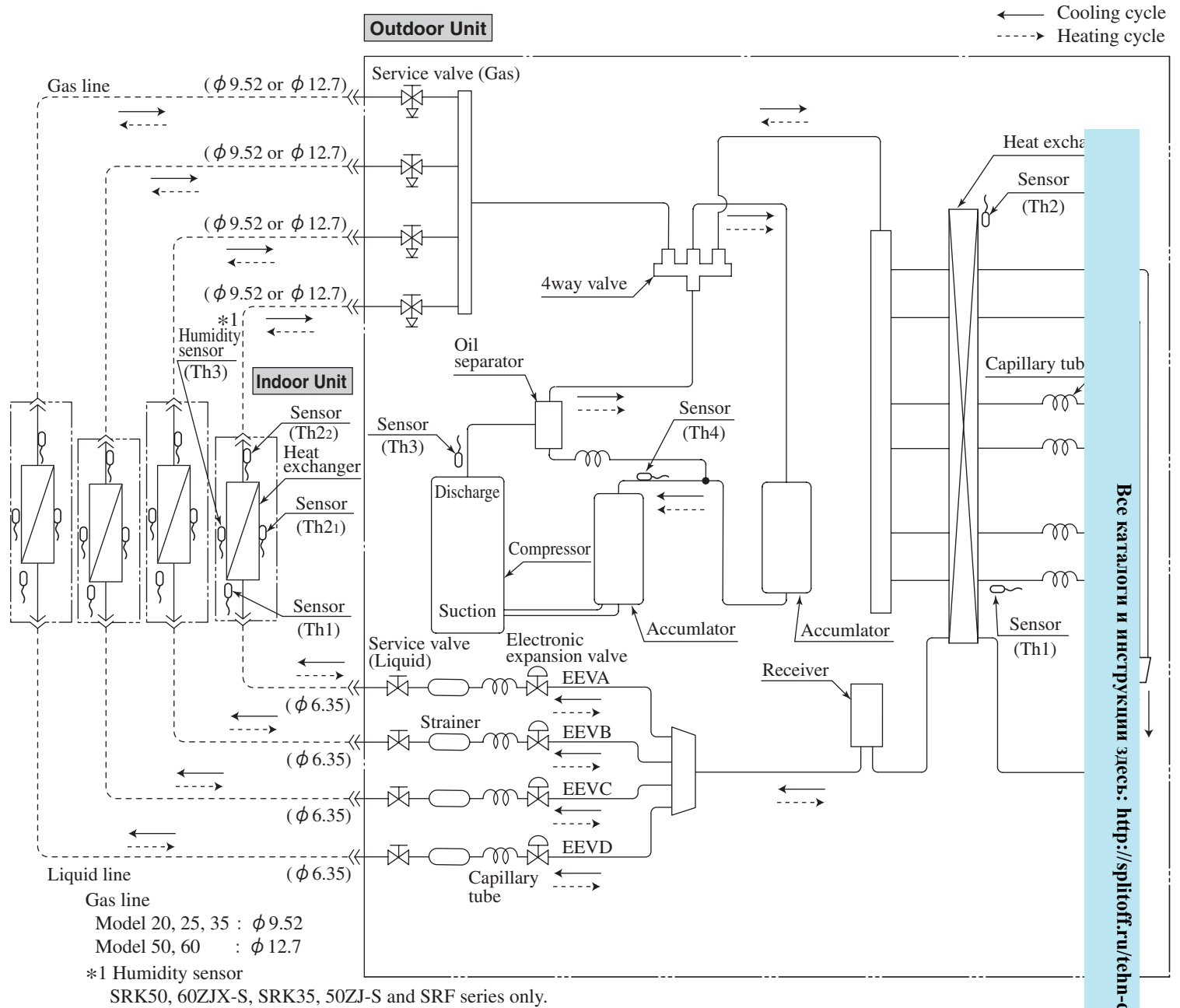

# 5. APPLICATION DATAS

## 5.1 Installation of outdoor unit

### (1) Models SCM40ZJ-S, 45ZJ-S

RPC012A915

MULTI TYPE AIR CONDITIONER  
R410A REFRIGERANT USED

• This installation manual deals with outdoor units and general installation specifications only. For indoor units, refer to page139 and 160.



ances between

Все каталоги и инструкции здесь: <http://splitoff.ru/tehn-doc.html>



- We recommend you to read this "SAFETY PRECAUTIONS" carefully before the installation work in order to gain full advantage of the functions of the unit and to avoid malfunction due to mishandling.
- The precautions described below are divided into **WARNING** and **CAUTION**. The matters with possibilities leading to serious consequences such as death or serious personal injury due to erroneous handling are listed in the **WARNING** and the matters with possibilities leading to personal injury or damage of the unit due to erroneous handling including probability leading to serious consequences in some cases are listed in **CAUTION**. These are very important precautions for safety. Be sure to observe all of them without fail.
- Be sure to confirm no anomaly on the equipment by commissioning after completed installation and explain the operating methods as well as the maintenance methods of this equipment to

the user according to the owner's manual.



- Keep the installation manual together with owner's manual at a place where any user can read at any time. Moreover if necessary, ask to hand them to a new user.
- For installing qualified personnel, take precautions in respect to themselves by using suitable protective clothing, gloves, etc., and then perform the installation works.
- Please pay attention not to fall down the tools, etc. when installing the unit at the high position.
- If unusual noise can be heard during operation, consult the dealer.
- Symbols which appear frequently in the text have the following meaning:

 Observe instructions with great care	 Strictly prohibited	 Provide proper earthing
--	---	---

### WARNING

<p> <b>Installation must be carried out by the qualified installer.</b> If you install the system by yourself, it may cause serious trouble such as water leaks, electric shocks, fire and personal injury, as a result of a system malfunction.</p> <p><b>Install the system in full accordance with the instruction manual.</b> Incorrect installation may cause bursts, personal injury, water leaks, electric shocks and fire.</p> <p><b>Be sure to use only for household and residence.</b> If this appliance is installed in inferior environment such as machine shop and etc., it can cause malfunction.</p> <p><b>Use the original accessories and the specified components for installation.</b> If parts other than those prescribed by us are used, it may cause water leaks, electric shocks, fire and personal injury.</p> <p><b>Install the unit in a location with good support.</b> Unsuitable installation locations can cause the unit to fall and cause material damage and personal injury.</p> <p><b>Ensure the unit is stable when installed, so that it can withstand earthquakes and strong winds.</b> Unsuitable installation locations can cause the unit to fall and cause material damage and personal injury.</p> <p><b>Ventilate the working area well in the event of refrigerant leakage during installation.</b> If the refrigerant comes into contact with naked flames, poisonous gas is produced.</p> <p><b>Use the prescribed pipes, flare nuts and tools for R410A.</b> Using existing parts (for R22 or R407C) can cause the unit failure and serious accidents due to burst of the refrigerant circuit.</p>	<p><b>Tighten the flare nut by torque wrench with specified method.</b> If the flare nut were tightened with excess torque, this may cause burst and refrigerant leakage after a long period.</p> <p><b>Do not open the operation valves for liquid line and gas line until completed refrigerant piping work, air tightness test and evacuation.</b> If the compressor is operated in state of opening operation valves before completed connection of refrigerant piping work, air can be sucked into refrigerant circuit, which can cause burst or personal injury due to anomalously high pressure in the refrigerant.</p> <p><b>The electrical installation must be carried out by the qualified electrician in accordance with "the norm for electrical work" and "national wiring regulation", and the system must be connected to the dedicated circuit.</b> Power supply with insufficient capacity and incorrect function done by improper work can cause electric shocks and fire.</p> <p><b>Be sure to shut off the power before starting electrical work.</b> Failure to shut off the power can cause electric shocks, unit failure or incorrect function of equipment.</p> <p><b>Be sure to use the cables conformed to safety standard and cable ampacity for power distribution work.</b> Unconformable cables can cause electric leak, anomalous heat production or fire.</p> <p><b>This appliance must be connected to main power supply by means of a circuit breaker or switch (fuse:25A) with a contact separation of at least 3mm.</b></p>	<p><b>Use the prescribed cables for electrical connection, tighten the cables securely in terminal block and relieve the cables correctly to prevent overloading the terminal blocks.</b> Loose connections or cable mountings can cause anomalous heat production or fire.</p> <p><b>Arrange the wiring in the control box so that it cannot be pushed up further into the box. Install the service panel correctly.</b> Incorrect installation may result in overheating and fire.</p> <p><b>Be sure to fix up the service panels.</b> Incorrect fixing can cause electric shocks or fire due to intrusion of dust or water.</p> <p><b>Be sure to switch off the power supply in the event of installation, inspection or servicing.</b> If the power supply is not shut off, there is a risk of electric shocks, unit failure or personal injury due to the unexpected start of fan.</p> <p><b>Stop the compressor before disconnecting refrigerant pipes in case of pump down operation.</b> If disconnecting refrigerant pipes in state of opening operation valves before compressor stopping, air can be sucked, which can cause burst or personal injury due to anomalously high pressure in the refrigerant circuit.</p> <p><b>Only use prescribed optional parts. The installation must be carried out by the qualified installer.</b> If you install the system by yourself, it can cause serious trouble such as water leaks, electric shocks, fire.</p>
<p> <b>Ensure that no air enters in the refrigerant circuit when the unit is installed and removed.</b> If air enters in the refrigerant circuit, the pressure in the refrigerant circuit becomes too high, which can cause burst and personal injury.</p> <p><b>Do not processing, splice the power cord, or share a socket with other power plugs.</b> This may cause fire or electric shock due to defecting contact, defecting insulation and over-current etc.</p>	<p><b>Do not bundling, winding or processing for the power cord. Or, do not deforming the power plug due to tread it.</b> This may cause fire or heating.</p> <p><b>Do not run the unit with removed panels or protections.</b> Touching rotating equipments, hot surfaces or high voltage parts can cause personal injury due to entrapment, burn or electric shocks.</p>	<p><b>Do not perform any change of protective device itself or its setup condition.</b> The forced operation by short-circuiting protective device of pressure switch and temperature controller or the use of non specified component can cause fire or burst.</p>
<p> <b>Carry out the electrical work for ground lead with care.</b> Do not connect the ground lead to the gas line, water line, lightning conductor or telephone line's ground lead. Incorrect grounding can cause unit faults such as electric shocks due to short-circuiting.</p>		

### CAUTION

<p> <b>Use the circuit breaker with sufficient breaking capacity.</b> If the breaker does not have sufficient breaking capacity, it can cause the unit malfunction and fire.</p> <p><b>Earth leakage breaker must be installed.</b> If the earth leakage breaker is not installed, it can cause electric shocks.</p> <p><b>Install isolator or disconnect switch on the power supply wiring in accordance with the local codes and regulations.</b></p> <p><b>After maintenance, all wiring, wiring ties and the like, should be returned to their original state and wiring route, and the necessary clearance from all metal parts should be secured.</b></p> <p><b>Secure a space for installation, inspection and maintenance specified in the manual.</b> Insufficient space can result in accident such as personal injury due to falling from the installation place.</p>	<p><b>Take care when carrying the unit by hand.</b> If the unit weights more than 20Kg, it must be carried by two or more persons. Do not carry by the plastic straps, always use the carry handle when carrying the unit by hand. Use gloves to minimize the risk of cuts by the aluminum fins.</p> <p><b>Dispose of any packing materials correctly.</b> Any remaining packing materials can cause personal injury as it contains nails and wood. And to avoid danger of suffocation, be sure to keep the plastic wrapper away from children and to dispose after tear it up.</p> <p><b>Be sure to insulate the refrigerant pipes so as not to condense the ambient air moisture on them.</b> Insufficient insulation can cause condensation, which can lead to moisture damage on the ceiling, floor, furniture and any other valuables.</p>	<p><b>When perform the air conditioner operation (cooling or drying operation) in which ventilator is installed in the room. In this case, using the air conditioner in parallel with the ventilator, there is the possibility that drain water may backflow in accordance with the room lapse into the negative pressure status. Therefore, set up the opening port such as incorporate the air into the room that may appropriate to ventilation (For example; Open the door a little). In addition, just as above, so set up the opening port if the room lapse into negative pressure status due to register of the wind for the high rise apartment etc.</b></p>
<p> <b>Do not install the unit in the locations listed below.</b></p> <ul style="list-style-type: none"> <li>• Locations where carbon fiber, metal powder or any powder is floating.</li> <li>• Locations where any substances that can affect the unit such as sulphide gas, chloride gas, acid and alkaline can occur.</li> <li>• Vehicles and ships.</li> <li>• Locations where cosmetic or special sprays are often used.</li> <li>• Locations with direct exposure of oil mist and steam such as kitchen and machine plant.</li> <li>• Locations where any machines which generate high frequency harmonics are used.</li> <li>• Locations with salty atmospheres such as coastlines.</li> <li>• Locations with heavy snow (If installed, be sure to provide</li> </ul>	<p>base flame and snow hood mentioned in the manual).</p> <ul style="list-style-type: none"> <li>• Locations where the unit is exposed to chimney smoke.</li> <li>• Locations at high altitude (more than 1000m high).</li> <li>• Locations with ammoniac atmospheres.</li> <li>• Locations where heat radiation from other heat source can affect the unit.</li> <li>• Locations without good air circulation.</li> <li>• Locations with any obstacles which can prevent inlet and outlet air of the unit.</li> <li>• Locations where short circuit of air can occur (in case of multiple units installation).</li> <li>• Locations where strong air blows against the air outlet of outdoor unit.</li> </ul> <p>It can cause remarkable decrease in performance, corrosion and damage of components, malfunction and fire.</p>	<p><b>Do not install the outdoor unit in the locations listed below.</b></p> <ul style="list-style-type: none"> <li>• Locations where discharged hot air or operating sound of the outdoor unit can bother neighborhood.</li> <li>• Locations where outlet air of the outdoor unit blows directly to plants.</li> <li>• Locations where vibration can be amplified and transmitted due to insufficient strength of structure.</li> <li>• Locations where vibration and operation sound generated by the outdoor unit can affect seriously (on the wall or at the place near bed room).</li> <li>• Locations where an equipment affected by high harmonics is placed (TV set or radio receiver is placed within 1m).</li> <li>• Locations where drainage cannot run off safely.</li> </ul> <p>It can affect surrounding environment and cause a claim.</p>

**CAUTION**

- Do not install the unit near the location where leakage of combustible gases can occur. If leaked gases accumulate around the unit, it can cause fire.
- Do not install the unit where corrosive gas (such as sulfurous acid gas etc.) or combustible gas (such as and breakdowns. The system can also affect medical equipment and telecommunication equipment, and obstruct its function or cause jamming.
- Do not install the outdoor unit in a location where insects and small animals can inhabit. Insects and small animals can enter the electric parts and
- Do not touch any buttons with wet hands. It can cause electric shocks.
- Do not touch any refrigerant pipes with your hands when the system is in operation. During operation the refrigerant pipes become extremely hot or extremely cold depending the operating condition, and it

Все каталоги и инструкции здесь: <http://splitoff.ru/tehn-doc.html>

um fin on the

- breakage of plastic parts and etc. And combustible gas can cause fire.
- Do not install nor use the system close to the equipment that generates electromagnetic fields or high frequency harmonics. Equipment such as inverters, standby generators, medical high frequency equipments and telecommunication equipments can affect the system, and cause malfunctions
- operation. Using an old and damage base flame can cause the unit falling down and cause personal injury.
- Do not use any materials other than a fuse with the correct rating in the location where fuses are to be used. Connecting the circuit with copper wire or other metal thread can cause unit failure and fire.
- Do not put anything on the outdoor unit and operating unit. This may cause damage the objects or injury due to falling to the object.

**Check before installation work**

- Model name and power source
- Refrigerant piping length
- Piping, wiring and miscellaneous small parts
- Indoor unit installation manual

Accessories for outdoor unit	Q'ty
① Grommet (Heat pump type only)	1
② Drain elbow (Heat pump type only)	1

Option parts	Q'ty
Ⓐ Sealing plate	1
Ⓑ Sleeve	1
Ⓒ Inclination plate	1
Ⓓ Putty	1
Ⓔ Drain hose (extension hose)	1
① Piping cover (for insulation of connection piping)	1

Necessary tools for the installation work
1 Plus headed driver
2 Knife
3 Saw
4 Tape measure
5 Hammer
6 Spanner wrench
7 Torque wrench [14.0~62.0N·m (1.4~6.2kgf·m)]
8 Hole core drill (65mm in diameter)

9 Wrench key (Hexagon) [4m/m]
10 Vacuum pump
11 Vacuum pump adapter (Anti-reverse flow type) (Designed specifically for R410A)
12 Gauge manifold (Designed specifically for R410A)
13 Charge hose (Designed specifically for R410A)
14 Flaring tool set (Designed specifically for R410A)
15 Gas leak detector (Designed specifically for R410A)
16 Gauge for projection adjustment (Used when flare is made by using conventional flare tool)

**1 SELECTION OF INSTALLATION LOCATION**

Install at location that meets the following conditions after getting approval from the customer.

- Where the following installation space is available, and where air does not gather.
- Where rain and sunlight do not directly hit the unit, and where there is enough air circulation.
- Also, where the unit cannot be buried by snow. a location which can sustain the weight of the unit, and where noises and vibrations are not enhanced.
- Where blasts of cold or hot air and noise do not bother the neighbors.
- Where the unit does not receive heat radiation from other heat sources.
- Where there are no obstructions (animals, plants, etc.) to the suction inlet and blowing outlet.
- Where water may drain out.
- Please avoid the following locations.
  - Where there is constant exposure to harsh winds such as the top floors of a building. Also, locations with exposure to salty air.
  - Where there are oil splashes, vapor, and smoke.
  - Where there are possibilities of flammable gas leaks.

① Installation Space (on a flat surface)

- Blowing out port and suction port on the back side of the unit can be installed at a distance of 10cm from walls.
  - In case the barrier is 1.2m or above in height, or is overhead, the sufficient space between the unit and wall shall be secured.
- When the unit is installed, the space of the following dimension and above shall be secured.

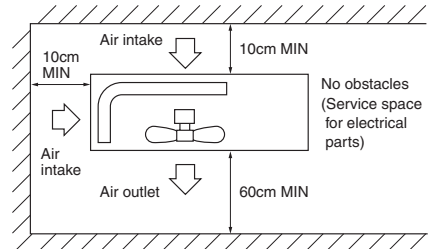

**Installation**

① Anchor bolt fixed position

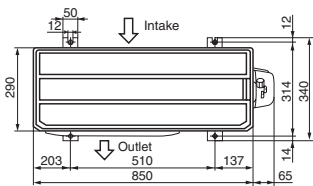

② Notabilia for installation

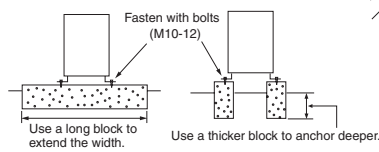

- In installing the unit, fix the unit's legs with bolts specified on the left.
  - The protrusion of an anchor bolt on the front side must be kept within 15 mm.
  - Securely install the unit so that it does not fall over during earthquakes or strong winds, etc.
  - Refer to the above illustrations for information regarding concrete foundations.
  - Install the unit in a level area. (With a gradient of 5 mm or less.)
- Improper installation can result in a compressor failure, broken piping within the unit and abnormal noise generation.

## 2 INSTALLATION OF OUTDOOR UNIT

### Drainage

- There are 2 holes in the bottom panel of the outdoor unit to drain condensation.
- Install the outdoor unit so it will be horizontal.

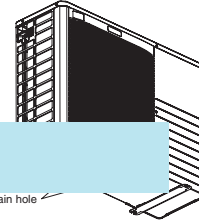

Все каталоги и инструкции здесь: <http://splitoff.ru/tehn-doc.html>

Connection of the power supply cable and the connecting cables for indoor and outdoor units.

- This multi-type room air conditioner receives its power from outside.
- To ensure correct connections, mark each ends of the cables with number, A and B. It is important to use the same number the corresponding cables and pipes.
- An earth leakage breaker and a circuit breaker must be installed. Their capacities are 25A.

- 1) Remove the service panel. (Remove the screw of the service panel.)
- 2) Remove the terminal cover. (Remove the screw of the terminal cover.)
- 3) Connect the power supply cable and the connection wire securely to the terminal block.

[POWER SUPPLY CODE]  
CENELEC code for cables requiring fields cables. H05RNR3G4.0  
[INTERCONNECTING WIRING CODE]  
CENELEC code for cables requiring fields cables. H05RNR4G1.5

- 1) In wiring, make sure that the wire terminal numbers of outdoor unit terminal block are match to the wire terminal numbers of indoor unit terminal block.
- 2) Terminal number A of the outdoor unit is used for A indoor unit and terminal number B for B indoor unit respectively.

- 4) After connecting the wire, use wiring clamps to secure the wiring.
- 5) Fit the terminal cover and the service panel.

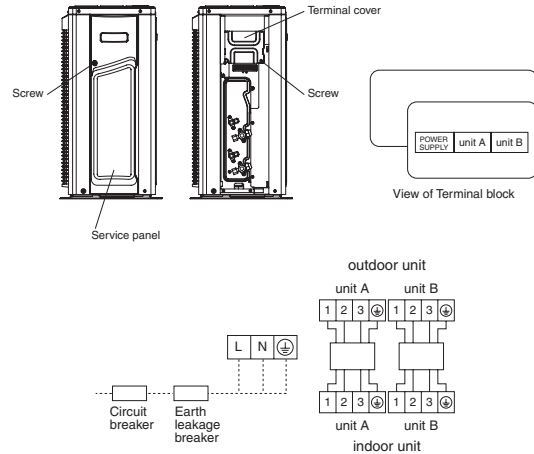

## 3 CONNECTION OF REFRIGERANT PIPINGS

[Connection of pipes]

NOTE

- Cover the pipes with tape so that dust and sand do not enter the pipe until they are connected.
- When connecting the pipes to the outdoor unit, be careful about the discharge of fluorocarbon gas or oil.
- Make sure to match the pipes between the indoor unit and the outdoor unit with the correct operation valves.

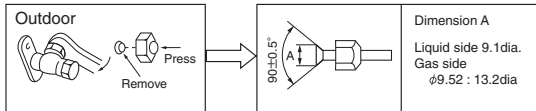

- Remove the flared nuts. (on both liquid and gas sides)

- Install the removed flared nuts to the pipes to be connected, then flare the pipes.

### CAUTION

Do not apply excess torque to the flared nuts. Otherwise, the flared nuts may crack depending on the conditions and refrigerant leak may occur.

### CAUTION

Do not apply refrigerating machine oil to the flared surface.

### Connection

#### Outdoor

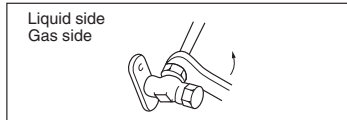

- Connect the pipes on both liquid and gas sides.
- Tighten the nuts to the following torque.  
Liquid side : 14.0~18.0N·m (1.4~1.8kgf·m)  
Gas side (φ9.52): 33.0~42.0N·m (3.3~4.2kgf·m)

#### Gas Leakage Test

- Ensure that there are no gas leaks from the pipe joints by using a leak detector or soap water.

Copper pipe diameter	Measurement B (mm)		
	Clutch type flare tool for R410A	Conventional (R22) flare tool	
		Clutch type	Wing nut type
φ6.35	0.0~0.5	1.0~1.5	1.5~2.0
φ9.52	0.0~0.5	1.0~1.5	1.5~2.0

Use a flare tool designed for R410A or a conventional flare tool. Please note that measurement B (protrusion from the flaring block) will vary depending on the type of a flare tool in use.

If a conventional flare tool is used, please use copper pipe gauge or a similar instrument to check protrusion so that you can keep measurement B to a correct value.

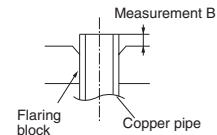

#### [Limit]

Limit	one indoor unit	MAX 25m
pipng length	all indoor unit	MAX 30m
hight difference	MAX 15m	MAX 25m
length of chargeless refrigerant pipe	30m	



### 4 AIR PURGING

**NOTE :** Fully open the operation valves (on both liquid and gas sides) after completing air purging.

- Since the system uses service ports differing in diameter from those found on the conventional models, a charge hose (for R22) presently in use is not applicable. Please use one designed specifically for R410A.
- Please use an anti-reverse flow type vacuum pump adapter so as to prevent vacuum pump oil from running back into the system. Oil running back into an air-conditioning system may cause the refrigerant cycle to break down.

**Procedure**

- (1) Secure all flare nuts on both indoor and outdoor sides to prevent leaks from the pipes.
- (2) Connect the operation valves, charge hose, manifold valve and vacuum pump as shown in the right figure.
- (3) Fully open the handle Lo for the manifold valve, and pump a vacuum for 15 minutes. Ensure that the meter is indicating -0.1MPa (-76cmHg).
- (4) After vacuuming, fully open the operation valve (both liquid and gas sides) with a hexagon wrench.
- (5) Remove the charge hose from service port.
- (6) Repeat the above steps (1) - (5) for all connected indoor units.
- (7) Ensure that there are no gas leaks from the joints in the indoor and outdoor units.

Operation valve size (mm)	Operation valve cap tightening torque (N·m)	Check joint blind nut tightening torque (N·m)
φ 6.35 (1/4")	20~30	10~12
φ 9.52 (3/8")		

### 5 HEAT INSULATION FOR JOINTS

**Heat insulation for joints**

Cover the joint with insulation material for the indoor unit and tape it.

**Finish and fixing**

Apply exterior tape and shape along the place where the pipes will be routed. Secure to the wall with a pipe clamp. Be careful not to damage the pipes and the wires.

### 7 BEWARE OF WRONG CONNECTIONS IN REFRIGERANT PIPING AND WIRING

- Make sure to match the piping and wiring from each unit to the outdoor unit.
- Be careful because if connections are wrong, normal operation cannot be achieved and may damage the compressor.

**[Correct connections]**      **[Example of wrong connections]**

### EARTHING WORK

- Earth work shall be carried out without fail in order to prevent electric shock and noise generation.
- The connection of the earth cable to the following substances causes dangerous failures, therefore it shall never be done. (City water pipe, Town gas pipe, TV antenna, lightning conductor, telephonenumber, etc.)

### 6 TEST RUN AND HANDLING INSTRUCTIONS

**Installation test check points**

Check the following points again after completion of the installation, and before turning on the power.

Conduct a test run again and ensure that the unit operates properly. At the same time, explain to the customer how to use the unit and how to take care of the unit following the installation manual.

If the compressor does not operate after the operation has started, wait for 5-10 minutes. (This may be due to delayed start.) (Three-minutes restart preventive timer)

When the air conditioner is restarted or when changing the operation, the unit will not start operating for approximately 3minutes. This is to protect the unit and it is not a malfunction.

**After installation**

- The power supply voltage is correct as the rating.
- No gas leaks from the joints of the operation valve.
- Power cables and crossover wires are securely fixed to the terminal board.
- Each indoor and outdoor unit is properly connected (no wrong wiring or piping).
- Operation valve is fully open.
- Refrigerant has been additionally charged (when the total pipe length exceeds the refrigerant charged pipe length).
- The pipe joints for indoor and outdoor pipes have been insulated.
- Earthing work has been conducted properly.

**Test run**

- Air conditioning and heating are normal.
- No abnormal noise.
- Water drains smoothly.
- Protective functions are not working.
- Operation of the unit has been explained to the customer.
- The remote control is normal.

**Operation of indicator lamps**

INDICATION LAMP	COLOR	FUNCTION
LED E (1)	RED	WARNING LAMP
SELF DIAGNOSIS FUNCTION BY LED E		
1 TIME FLASH		CURRENT CUT
2 TIME FLASH		TROUBLE OF OUTDOOR UNIT
3 TIME FLASH		OVER CURRENT
4 TIME FLASH		TRANSMISSION ERROR IN OUTDOOR UNIT PCB
5 TIME FLASH		OVER HEAT OF COMPRESSOR
6 TIME FLASH		ERROR OF SIGNAL TRANSMISSION
7 TIME FLASH		LOCK OF COMPRESSOR
8 TIME FLASH		SENSOR ERROR (EXCEPT DISCHARGE PIPE SENSOR)
LIGHT ON		OUTDOOR FAN MOTOR ERROR
FOUR SEC LIGHT AND FOUR SEC OFF		DISCHARGE PIPE SENSOR ERROR

(2) Models SCM50ZJ-S, 60ZJ-S

RPC012A916A

MULTI TYPE AIR CONDITIONER  
R410A REFRIGERANT USED

- This installation manual deals with outdoor units and general installation specifications only. For indoor units, refer to page139 and 160.
- When install the unit, be sure to check whether the selection of installation place, power supply specifications, usage limitation (piping length, height differences between

Все каталоги и инструкции здесь: <http://splitoff.ru/tehn-doc.html>

- We recommend you to read this "SAFETY PRECAUTIONS" carefully before the installation work in order to gain full advantage of the functions of the unit and to avoid malfunction due to mishandling.
- The precautions described below are divided into [A WARNING] and [A CAUTION]. The matters with possibilities leading to serious consequences such as death or serious personal injury due to erroneous handling are listed in the [A WARNING] and the matters with possibilities leading to personal injury or damage of the unit due to erroneous handling including probability leading to serious consequences in some cases are listed in [A CAUTION]. These are very important precautions for safety. Be sure to observe all of them without fail.
- Be sure to confirm no anomaly on the equipment by commissioning after completed installation and explain the operating methods as well as the maintenance methods of this equipment to

the user according to the owner's manual.

- Keep the installation manual together with owner's manual at a place where any user can read at any time. Moreover if necessary, ask to hand them to a new user.
- For installing qualified personnel, take precautions in respect to themselves by using suitable protective clothing, gloves, etc., and then perform the installation works.
- Please pay attention not to fall down the tools, etc. when installing the unit at the high position.
- If unusual noise can be heard during operation, consult the dealer.
- Symbols which appear frequently in the text have the following meaning:

	Observe instructions with great care		Strictly prohibited		Provide proper earthing
--	--------------------------------------	--	---------------------	--	-------------------------

**⚠ WARNING**

<p><b>!</b></p> <ul style="list-style-type: none"> <li>• <b>Installation must be carried out by the qualified installer.</b> If you install the system by yourself, it may cause serious trouble such as water leaks, electric shocks, fire and personal injury, as a result of a system malfunction.</li> <li>• <b>Install the system in full accordance with the instruction manual.</b> Incorrect installation may cause bursts, personal injury, water leaks, electric shocks and fire.</li> <li>• <b>Be sure to use only for household and residence.</b> If this appliance is installed in inferior environment such as machine shop and etc., it can cause malfunction.</li> <li>• <b>Use the original accessories and the specified components for installation.</b> If parts other than those prescribed by us are used, it may cause water leaks, electric shocks, fire and personal injury.</li> <li>• <b>Install the unit in a location with good support.</b> Unsuitable installation locations can cause the unit to fall and cause material damage and personal injury.</li> <li>• <b>Ensure the unit is stable when installed, so that it can withstand earthquakes and strong winds.</b> Unsuitable installation locations can cause the unit to fall and cause material damage and personal injury.</li> <li>• <b>Ventilate the working area well in the event of refrigerant leakage during installation.</b> If the refrigerant comes into contact with naked flames, poisonous gas is produced.</li> <li>• <b>Use the prescribed pipes, flare nuts and tools for R410A.</b> Using existing parts (for R22 or R407C) can cause the unit failure and serious accidents due to burst of the refrigerant circuit.</li> </ul>	<ul style="list-style-type: none"> <li>• <b>Tighten the flare nut by torque wrench with specified method.</b> If the flare nut were tightened with excess torque, this may cause burst and refrigerant leakage after a long period.</li> <li>• <b>Do not open the operation valves for liquid line and gas line until completed refrigerant piping work, air tightness test and evacuation.</b> If the compressor is operated in state of opening operation valves before completed connection of refrigerant piping work, air can be sucked into refrigerant circuit, which can cause burst or personal injury due to anomalously high pressure in the refrigerant.</li> <li>• <b>The electrical installation must be carried out by the qualified electrician in accordance with "the norm for electrical work" and "national wiring regulation", and the system must be connected to the dedicated circuit.</b> Power supply with insufficient capacity and incorrect function done by improper work can cause electric shocks and fire.</li> <li>• <b>Be sure to shut off the power before starting electrical work.</b> Failure to shut off the power can cause electric shocks, unit failure or incorrect function of equipment.</li> <li>• <b>Be sure to use the cables conformed to safety standard and cable ampacity for power distribution work.</b> Unconformable cables can cause electric leak, anomalous heat production or fire.</li> <li>• <b>This appliance must be connected to main power supply by means of a circuit breaker or switch (fuse:25A) with a contact separation of at least 3mm.</b></li> </ul>	<ul style="list-style-type: none"> <li>• <b>Use the prescribed cables for electrical connection, tighten the cables securely in terminal block and relieve the cables correctly to prevent overloading the terminal blocks.</b> Loose connections or cable mountings can cause anomalous heat production or fire.</li> <li>• <b>Arrange the wiring in the control box so that it cannot be pushed up further into the box. Install the service panel correctly.</b> Incorrect installation may result in overheating and fire.</li> <li>• <b>Be sure to fix up the service panels.</b> Incorrect fixing can cause electric shocks or fire due to intrusion of dust or water.</li> <li>• <b>Be sure to switch off the power supply in the event of installation, inspection or servicing.</b> If the power supply is not shut off, there is a risk of electric shocks, unit failure or personal injury due to the unexpected start of fan.</li> <li>• <b>Stop the compressor before disconnecting refrigerant pipes in case of pump down operation.</b> If disconnecting refrigerant pipes in state of opening operation valves before compressor stopping, air can be sucked, which can cause burst or personal injury due to anomalously high pressure in the refrigerant circuit.</li> <li>• <b>Only use prescribed optional parts. The installation must be carried out by the qualified installer.</b> If you install the system by yourself, it can cause serious trouble such as water leaks, electric shocks, fire.</li> </ul>
<p><b>⊘</b></p> <ul style="list-style-type: none"> <li>• <b>Ensure that no air enters in the refrigerant circuit when the unit is installed and removed.</b> If air enters in the refrigerant circuit, the pressure in the refrigerant circuit becomes too high, which can cause burst and personal injury.</li> <li>• <b>Do not processing, splice the power cord, or share a socket with other power plugs.</b> This may cause fire or electric shock due to defecting contact, defecting insulation and over-current etc.</li> </ul>	<ul style="list-style-type: none"> <li>• <b>Do not bundling, winding or processing for the power cord. Or, do not deforming the power plug due to tread it.</b> This may cause fire or heating.</li> <li>• <b>Do not run the unit with removed panels or protections.</b> Touching rotating equipments, hot surfaces or high voltage parts can cause personal injury due to entrapment, burn or electric shocks.</li> </ul>	<ul style="list-style-type: none"> <li>• <b>Do not perform any change of protective device itself or its setup condition.</b> The forced operation by short-circuiting protective device of pressure switch and temperature controller or the use of non specified component can cause fire or burst.</li> </ul>
<p><b>⚡</b></p> <ul style="list-style-type: none"> <li>• <b>Carry out the electrical work for ground lead with care.</b> Do not connect the ground lead to the gas line, water line, lightning conductor or telephone line's ground lead. Incorrect grounding can cause unit faults such as electric shocks due to short-circuiting.</li> </ul>		

**⚠ CAUTION**

<p><b>!</b></p> <ul style="list-style-type: none"> <li>• <b>Use the circuit breaker with sufficient breaking capacity.</b> If the breaker does not have sufficient breaking capacity, it can cause the unit malfunction and fire.</li> <li>• <b>Earth leakage breaker must be installed.</b> If the earth leakage breaker is not installed, it can cause electric shocks.</li> <li>• <b>Install isolator or disconnect switch on the power supply wiring in accordance with the local codes and regulations.</b></li> <li>• <b>After maintenance, all wiring, wiring ties and the like, should be returned to their original state and wiring route, and the necessary clearance from all metal parts should be secured.</b></li> <li>• <b>Secure a space for installation, inspection and maintenance specified in the manual.</b> Insufficient space can result in accident such as personal injury due to falling from the installation place.</li> </ul>	<ul style="list-style-type: none"> <li>• <b>Take care when carrying the unit by hand.</b> If the unit weights more than 20kg, it must be carried by two or more persons. Do not carry by the plastic straps, always use the carry handle when carrying the unit by hand. Use gloves to minimize the risk of cuts by the aluminum fins.</li> <li>• <b>Dispose of any packing materials correctly.</b> Any remaining packing materials can cause personal injury as it contains nails and wood. And to avoid danger of suffocation, be sure to keep the plastic wrapper away from children and to dispose after tear it up.</li> <li>• <b>Be sure to insulate the refrigerant pipes so as not to condense the ambient air moisture on them.</b> Insufficient insulation can cause condensation, which can lead to moisture damage on the ceiling, floor, furniture and any other valuables.</li> </ul>	<ul style="list-style-type: none"> <li>• <b>When perform the air conditioner operation (cooling or drying operation) in which ventilator is installed in the room. In this case, using the air conditioner in parallel with the ventilator, there is the possibility that drain water may backflow in accordance with the room lapse into the negative pressure status. Therefore, set up the opening port such as incorporate the air into the room that may appropriate to ventilation (For example; Open the door a little). In addition, just as above, so set up the opening port if the room lapse into negative pressure status due to register of the wind for the high rise apartment etc.</b></li> </ul>
<p><b>⊘</b></p> <ul style="list-style-type: none"> <li>• <b>Do not install the unit in the locations listed below.</b> <ul style="list-style-type: none"> <li>• Locations where carbon fiber, metal powder or any-powder is floating.</li> <li>• Locations where any substances that can affect the unit such as sulphide gas, chloride gas, acid and alkaline can occur.</li> <li>• Vehicles and ships.</li> <li>• Locations where cosmetic or special sprays are often used.</li> <li>• Locations with direct exposure of oil mist and steam such as kitchen and machine plant.</li> <li>• Locations where any machines which generate high frequency harmonics are used.</li> <li>• Locations with salty atmospheres such as coastlines.</li> <li>• Locations with heavy snow (if installed, be sure to provide</li> </ul> </li> </ul>	<ul style="list-style-type: none"> <li>• base flame and snow hood mentioned in the manual).</li> <li>• Locations where the unit is exposed to chimney smoke.</li> <li>• Locations at high altitude (more than 1000m high).</li> <li>• Locations with ammoniac atmospheres.</li> <li>• Locations where heat radiation from other heat source can affect the unit.</li> <li>• Locations without good air circulation.</li> <li>• Locations with any obstacles which can prevent inlet and outlet air of the unit.</li> <li>• Locations where short circuit of air can occur (in case of multiple units installation).</li> <li>• Locations where strong air blows against the air outlet of outdoor unit.</li> </ul> <p>It can cause remarkable decrease in performance, corrosion and damage of components, malfunction and fire.</p>	<ul style="list-style-type: none"> <li>• <b>Do not install the outdoor unit in the locations listed below.</b> <ul style="list-style-type: none"> <li>• Locations where discharged hot air or operating sound of the outdoor unit can bother neighborhood.</li> <li>• Locations where outlet air of the outdoor unit blows directly to plants.</li> <li>• Locations where vibration can be amplified and transmitted due to insufficient strength of structure.</li> <li>• Locations where vibration and operation sound generated by the outdoor unit can affect seriously (on the wall or at the place near bed room).</li> <li>• Locations where an equipment affected by high harmonics is placed (TV set or radio receiver is placed within 1m).</li> <li>• Locations where drainage cannot run off safely.</li> <li>• It can affect surrounding environment and cause a claim.</li> </ul> </li> </ul>



**CAUTION**

- Do not install the unit near the location where leakage of combustible gases can occur. If leaked gases accumulate around the unit, it can cause fire.
- Do not install the unit where corrosive gas (such as sulfuric acid gas etc.) or combustible gas (such as
- and breakdowns. The system can also affect medical equipment and telecommunication equipment, and obstruct its function or cause jamming.
- Do not install the outdoor unit in a location where insects and small animals can inhabit. Insects and small animals can enter the electric parts and
- Do not touch any buttons with wet hands. It can cause electric shocks.
- Do not touch any refrigerant pipes with your hands when the system is in operation. During operation the refrigerant pipes become extremely hot or extremely cold depending the operating condition, and it

Все каталоги и инструкции здесь: <http://splitoff.ru/tehn-doc.html>

um fln on the

- breakage of plastic parts and etc. And combustible gas can cause fire.
- Do not install nor use the system close to the equipment that generates electromagnetic fields or high frequency harmonics. Equipment such as inverters, standby generators, medical high frequency equipments and telecommunication equipments can affect the system, and cause malfunctions

- operation. Using an old and damage base flame can cause the unit falling down and cause personal injury.
- Do not use any materials other than a fuse with the correct rating in the location where fuses are to be used. Connecting the circuit with copper wire or other metal thread can cause unit failure and fire.

- Do not put anything on the outdoor unit and operating unit. This may cause damage the objects or injury due to falling to the object.

**Check before installation work**

- Model name and power source
- Refrigerant piping length
- Piping, wiring and miscellaneous small parts
- Indoor unit installation manual

Accessories for outdoor unit	Q'ty
① Grommet (Heat pump type only)	1
② Drain elbow (Heat pump type only)	1
③ Variable diameter joint	SCM50 1
φ9.52→φ12.7	SCM60 2

Note: Provide flare nuts when using the variable diameter joint (for φ12.7).

Option parts	Q'ty	Necessary tools for the installation work
Ⓐ Sealing plate	1	1 Plus headed driver
Ⓑ Sleeve	1	2 Knife
Ⓒ Inclination plate	1	3 Saw
Ⓓ Putty	1	4 Tape measure
Ⓔ Drain hose (extension hose)	1	5 Hammer
Ⓕ Piping cover (for insulation of connection piping)	1	6 Spanner wrench
		7 Torque wrench (14.0~62.0N·m (1.4~6.2kgf·m))
		8 Hole core drill (65mm in diameter)
		9 Wrench key (Hexagon) (4m/m)
		10 Vacuum pump
		11 Vacuum pump adapter (Anti-reverse flow type) (Designed specifically for R410A)
		12 Gauge manifold (Designed specifically for R410A)
		13 Charge hose (Designed specifically for R410A)
		14 Flaring tool set (Designed specifically for R410A)
		15 Gas leak detector (Designed specifically for R410A)
		16 Gauge for projection adjustment (Used when flare is made by using conventional flare tool)

**CAUTION** • This model requires a minimum of 2 indoor units.

**1 SELECTION OF INSTALLATION LOCATION**

Install at location that meets the following conditions after getting approval from the customer.

- Where the following installation space is available, and where air does not gather.
- Where rain and sunlight do not directly hit the unit, and where there is enough air circulation.
- Also, where the unit cannot be buried by snow. a location which can sustain the weight of the unit, and where noises and vibrations are not enhanced.
- Where blasts of cold or hot air and noise do not bother the neighbors.
- Where the unit does not receive heat radiation from other heat sources.
- Where there are no obstructions (animals, plants, etc.) to the suction inlet and blowing outlet.
- Where water may drain out.
- ※ Please avoid the following locations.
  - Where there is constant exposure to harsh winds such as the top floors of a building. Also, locations with exposure to salty air.
  - Where there are oil splashes, vapor, and smoke.
  - Where there are possibilities of flammable gas leaks.

① Installation Space (on a flat surface)

- Blowing out port and suction port on the back side of the unit can be installed at a distance of 10cm from walls. (In case the barrier is 1.2m or above in height, or is overhead, the sufficient space between the unit and wall shall be secured.)
- When the unit is installed, the space of the following dimension and above shall be secured.

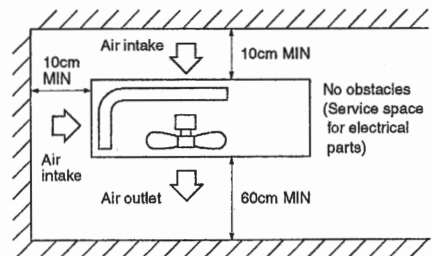

**Installation**

① Anchor bolt fixed position

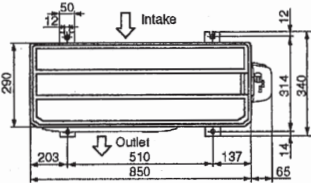

② Notabilia for installation

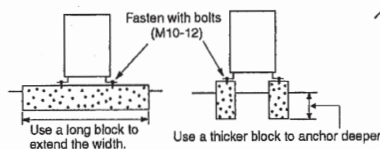

- In installing the unit, fix the unit's legs with bolts specified on the left.
- The protrusion of an anchor bolt on the front side must be kept within 15 mm.
- Securely install the unit so that it does not fall over during earthquakes or strong winds, etc.
- Refer to the above illustrations for information regarding concrete foundations.
- Install the unit in a level area. (With a gradient of 5 mm or less.)
- Improper installation can result in a compressor failure, broken piping within the unit and abnormal noise generation.

## 2 INSTALLATION OF OUTDOOR UNIT

### Drainage

- There are 2 holes in the bottom panel of the outdoor unit to drain condensation.
- Install the outdoor unit so it will be horizontal.

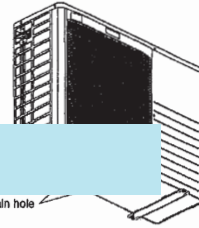

Все каталоги и инструкции здесь: <http://splitoff.ru/tehn-doc.html>

Connection of the power supply cable and the connecting cables for indoor and outdoor units.

- This multi-type room air conditioner receives its power from outside.
- To ensure correct connections, mark each ends of the cables with number, A to C. It is important to use the same number the corresponding cables and pipes.
- An earth leakage breaker and a circuit breaker must be installed. Their capacities are 25A.

- 1) Remove the service panel. (Remove the screw of the service panel.)
- 2) Remove the terminal cover. (Remove the screw of the terminal cover.)
- 3) Connect the power supply cable and the connection wire securely to the terminal block.

[POWER SUPPLY CODE]  
CENELEC code for cables requiring fields cables. H05RNR3G4.0  
[INTERCONNECTING WIRING CODE]  
CENELEC code for cables requiring fields cables. H05RNR4G1.5

- 1) In wiring, make sure that the wire terminal numbers of outdoor unit terminal block are match to the wire terminal numbers of indoor unit terminal block.
- 2) Terminal number A of the outdoor unit is used for A indoor unit and terminal number B for B indoor unit respectively.

- 4) After connecting the wire, use wiring clamps to secure the wiring.
- 5) Fit the terminal cover and the service panel.

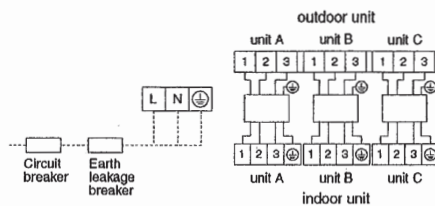
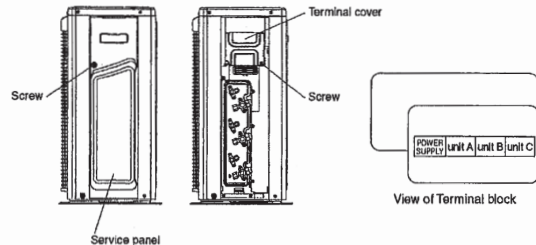

## 3 CONNECTION OF REFRIGERANT PIPINGS

- Regarding the change in the sizes of gas side pipes (usage of the variable joints); If a 5.0, 6.0 kw class indoor unit (gas side pipe 12.7) is going to be connected to the operation valves (9.52), variable joints available as accessories must be applied to the gas side operation valves.
- Securely fit the copper packing between the operation valve and the variable diameter joint to prevent shifting.

[Examples of use of variable diameter joints]

- Connection of indoor unit of Class 5.0 to A unit.

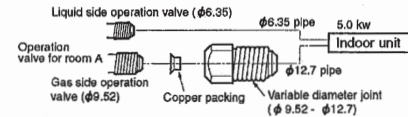

[Connection of pipes]

### NOTE

- Cover the pipes with tape so that dust and sand do not enter the pipe until they are connected.
- When connecting the pipes to the outdoor unit, be careful about the discharge of fluorocarbon gas or oil.
- Make sure to match the pipes between the indoor unit and the outdoor unit with the correct operation valves.

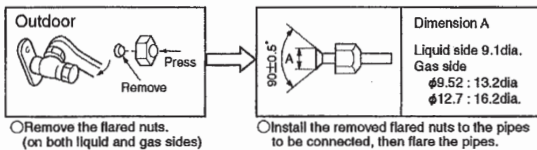

- Remove the flared nuts. (on both liquid and gas sides)
- Install the removed flared nuts to the pipes to be connected, then flare the pipes.

### CAUTION

Do not apply excess torque to the flared nuts. Otherwise, the flared nuts may crack depending on the conditions and refrigerant leak may occur.

### CAUTION

Do not apply refrigerating machine oil to the flared surface.

Copper pipe diameter	Measurement B (mm)		
	Clutch type flare tool for R410A	Conventional (R22) flare tool	
		Clutch type	Wing nut type
φ6.35	0.0~0.5	1.0~1.5	1.5~2.0
φ9.52	0.0~0.5	1.0~1.5	1.5~2.0
φ12.7	0.0~0.5	1.0~1.5	2.0~2.5

Use a flare tool designed for R410A or a conventional flare tool. Please note that measurement B (protrusion from the flaring block) will vary depending on the type of a flare tool in use.

If a conventional flare tool is used, please use copper pipe gauge or a similar instrument to check protrusion so that you can keep measurement B to a correct value.

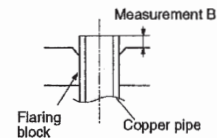

## Connection

### Outdoor

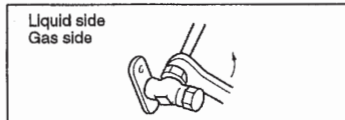

- Connect the pipes on both liquid and gas sides.
- Tighten the nuts to the following torque.  
Liquid side : 14.0~18.0N·m (1.4~1.8kgf·m)  
Gas side (φ9.52): 33.0~42.0N·m (3.3~4.2kgf·m)  
(φ12.7): 49.0~61.0N·m (4.9~6.1kgf·m)

### Gas Leakage Test

- Ensure that there are no gas leaks from the pipe joints by using a leak detector or soap water.

### [Limit]

piping length	one indoor unit		MAX 25m MAX 40m
	all indoor unit	indoor unit	
height difference	MAX 25m	MAX 15m	indoor unit
		MAX 15m	indoor unit
length of chargeless refrigerant pipe	40m		

**4 AIR PURGING**

NOTE : Fully open the operation valves (on both liquid and gas sides) after completing air purging.

- Since the system uses service ports differing in diameter from those found on the conventional models, a charge hose (for R22) presently in use is not applicable. Please use one designed specifically for R410A.
- Please use an anti-reverse flow type vacuum pump adapter so as to prevent vacuum pump oil from running back into the system. Oil running back into an air-conditioning system may cause the refrigerant cycle to break down.

Все каталоги и инструкции здесь: <http://splitoff.ru/tehn-doc.html>

**Procedure**

- (1) Secure all flare nuts on both indoor and outdoor sides to prevent leaks from the pipes.
- (2) Connect the operation valves, charge hose, manifold valve and vacuum pump as shown in the right figure.
- (3) Fully open the handle Lo for the manifold valve, and pump a vacuum for 15 minutes. Ensure that the meter is indicating -0.1MPa (-76cmHg).
- (4) After vacuuming, fully open the operation valve (both liquid and gas sides) with a hexagon wrench.

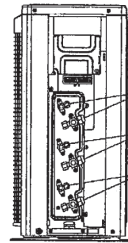
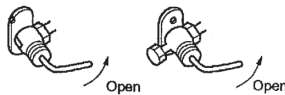

Operation valve for room C  
Operation valve for room B  
Operation valve for room A

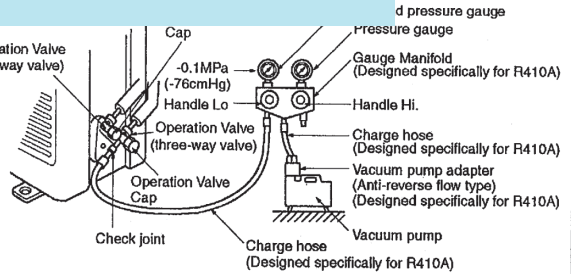

Securely tighten the operation valve cap and the check joint blind nut after adjustment.

Operation valve size (mm)	Operation valve cap tightening torque (N·m)	Check joint blind nut tightening torque (N·m)
φ 6.35 (1/4")	20~30	10~12
φ 9.52 (3/8")		
φ 12.7 (1/2")	25~35	

- (5) Remove the charge hose from service port.
- (6) Repeat the above steps (1) ~ (5) for all connected indoor units.
- (7) Ensure that there are no gas leaks from the joints in the indoor and outdoor units.

**5 HEAT INSULATION FOR JOINTS**

Heat insulation for joints

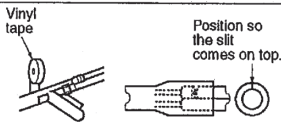

Cover the joint with insulation material for the indoor unit and tape it.

Finish and fixing

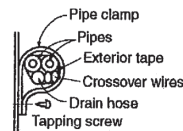

Apply exterior tape and shape along the place where the pipes will be routed. Secure to the wall with a pipe clamp. Be careful not to damage the pipes and the wires.

**7 BEWARE OF WRONG CONNECTIONS IN REFRIGERANT PIPING AND WIRING**

- Make sure to match the piping and wiring from each unit to the outdoor unit.
- Be careful because if connections are wrong, normal operation cannot be achieved and may damage the compressor.

[Correct connections]

[Example of wrong connections]

— Piping  
- - - - - Wiring

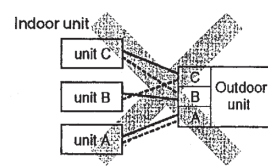
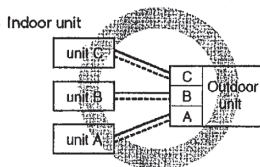

**EARTHING WORK**

- Earth work shall be carried out without fail in order to prevent electric shock and noise generation.
- The connection of the earth cable to the following substances causes dangerous failures, therefore it shall never be done. (City water pipe, Town gas pipe, TV antenna, lightning conductor, telephoneline, etc.)

**6 TEST RUN AND HANDLING INSTRUCTIONS**

Installation test check points

Check the following points again after completion of the installation, and before turning on the power.  
Conduct a test run again and ensure that the unit operates properly.  
At the same time, explain to the customer how to use the unit and how to take care of the unit following the installation manual.  
If the compressor does not operate after the operation has started, wait for 5-10 minutes. (This may be due to delayed start.)  
(Three-minutes restart preventive timer)  
When the air conditioner is restarted or when changing the operation, the unit will not start operating for approximately 3minutes. This is to protect the unit and it is not a malfunction.

After installation

- The power supply voltage is correct as the rating.
- No gas leaks from the joints of the operation valve.
- Power cables and crossover wires are securely fixed to the terminal board.
- Each indoor and outdoor unit is properly connected (no wrong wiring or piping).
- Operation valve is fully open.
- Refrigerant has been additionally charged (when the total pipe length exceeds the refrigerant charged pipe length).
- The pipe joints for indoor and outdoor pipes have been insulated.
- Earthing work has been conducted properly.

Test run

- Air conditioning and heating are normal.
- No abnormal noise.
- Water drains smoothly.
- Protective functions are not working.
- Operation of the unit has been explained to the customer.
- The remote control is normal.

Operation of indicator lamps

INDICATION LAMP	COLOR	FUNCTION
LED E (1)	RED	WARNING LAMP
SELF DIAGNOSIS FUNCTION BY LED E		
1 TIME FLASH		CURRENT CUT
2 TIME FLASH		TROUBLE OF OUTDOOR UNIT
3 TIME FLASH		OVER CURRENT
4 TIME FLASH		TRANSMISSION ERROR IN OUTDOOR UNIT PCB
5 TIME FLASH		OVER HEAT OF COMPRESSOR
6 TIME FLASH		ERROR OF SIGNAL TRANSMISSION
7 TIME FLASH		LOCK OF COMPRESSOR
8 TIME FLASH		SENSOR ERROR (EXCEPT DISCHARGE PIPE SENSOR)
LIGHT ON		OUTDOOR FAN MOTOR ERROR
FOUR SEC LIGHT AND FOUR SEC OFF		DISCHARGE PIPE SENSOR ERROR



(3) Models SCM71ZJ-S, 80ZJ-S

RPC012A913

MULTI TYPE AIR CONDITIONER  
R410A REFRIGERANT USED

- This installation manual deals with outdoor units and general installation specifications only. For indoor units, refer to page 139 and 160.
- When install the unit, be sure to check whether the selection of installation place, power supply specifications, usage limitation (piping length, height differences between

Все каталоги и инструкции здесь: <http://splitoff.ru/tehn-doc.html>

- We recommend you to read this "SAFETY PRECAUTIONS" carefully before the installation work in order to gain full advantage of the functions of the unit and to avoid malfunction due to mishandling.
- The precautions described below are divided into **WARNING** and **CAUTION**. The matters with possibilities leading to serious consequences such as death or serious personal injury due to erroneous handling are listed in the **WARNING** and the matters with possibilities leading to personal injury or damage of the unit due to erroneous handling including probability leading to serious consequences in some cases are listed in **CAUTION**. These are very important precautions for safety. Be sure to observe all of them without fail.
- Be sure to confirm no anomaly on the equipment by commissioning after completed installation and explain the operating methods as well as the maintenance methods of this equipment to

- the user according to the Owner's manual.
- Keep the installation manual together with owner's manual at a place where any user can read at any time. Moreover if necessary, ask to hand them to a new user.
- For installing qualified personnel, take precautions in respect to themselves by using suitable protective clothing, gloves, etc., and then perform the installation works.
- Please pay attention not to fall down the tools, etc. when installing the unit at the high position.
- If unusual noise can be heard during operation, consult the dealer.
- Symbols which appear frequently in the text have the following meaning:

	Observe instructions with great care		Strictly prohibited		Provide proper earthing
--	--------------------------------------	--	---------------------	--	-------------------------

**WARNING**

<p></p> <ul style="list-style-type: none"> <li>• <b>Installation must be carried out by the qualified installer.</b> If you install the system by yourself, it may cause serious trouble such as water leaks, electric shocks, fire and personal injury, as a result of a system malfunction.</li> <li>• <b>Install the system in full accordance with the instruction manual.</b> Incorrect installation may cause bursts, personal injury, water leaks, electric shocks and fire.</li> <li>• <b>Be sure to use only for household and residence.</b> If this appliance is installed in inferior environment such as machine shop and etc., it can cause malfunction.</li> <li>• <b>Use the original accessories and the specified components for installation.</b> If parts other than those prescribed by us are used, it may cause water leaks, electric shocks, fire and personal injury.</li> <li>• <b>Install the unit in a location with good support.</b> Unsuitable installation locations can cause the unit to fall and cause material damage and personal injury.</li> <li>• <b>Ensure the unit is stable when installed, so that it can withstand earthquakes and strong winds.</b> Unsuitable installation locations can cause the unit to fall and cause material damage and personal injury.</li> <li>• <b>Ventilate the working area well in the event of refrigerant leakage during installation.</b> If the refrigerant comes into contact with naked flames, poisonous gas is produced.</li> <li>• <b>Use the prescribed pipes, flare nuts and tools for R410A.</b> Using existing parts (for R22 or R407C) can cause the unit failure and serious accidents due to burst of the refrigerant circuit.</li> </ul>	<ul style="list-style-type: none"> <li>• <b>Tighten the flare nut by torque wrench with specified method.</b> If the flare nut were tightened with excess torque, this may cause burst and refrigerant leakage after a long period.</li> <li>• <b>Do not open the operation valves for liquid line and gas line until completed refrigerant piping work, air tightness test and evacuation.</b> If the compressor is operated in state of opening operation valves before completed connection of refrigerant piping work, air can be sucked into refrigerant circuit, which can cause burst or personal injury due to anomalously high pressure in the refrigerant.</li> <li>• <b>The electrical installation must be carried out by the qualified electrician in accordance with "the norm for electrical work" and "national wiring regulation", and the system must be connected to the dedicated circuit.</b> Power supply with insufficient capacity and incorrect function done by improper work can cause electric shocks and fire.</li> <li>• <b>Be sure to shut off the power before starting electrical work.</b> Failure to shut off the power can cause electric shocks, unit failure or incorrect function of equipment.</li> <li>• <b>Be sure to use the cables conformed to safety standard and cable ampacity for power distribution work.</b> Unconformable cables can cause electric leak, anomalous heat production or fire.</li> <li>• <b>This appliance must be connected to main power supply by means of a circuit breaker or switch (fuse:25A) with a contact separation of at least 3mm.</b></li> </ul>	<ul style="list-style-type: none"> <li>• <b>Use the prescribed cables for electrical connection, tighten the cables securely in terminal block and relieve the cables correctly to prevent overloading the terminal blocks.</b> Loose connections or cable mountings can cause anomalous heat production or fire.</li> <li>• <b>Arrange the wiring in the control box so that it cannot be pushed up further into the box. Install the service panel correctly.</b> Incorrect installation may result in overheating and fire.</li> <li>• <b>Be sure to fix up the service panels.</b> Incorrect fixing can cause electric shocks or fire due to intrusion of dust or water.</li> <li>• <b>Be sure to switch off the power supply in the event of installation, inspection or servicing.</b> If the power supply is not shut off, there is a risk of electric shocks, unit failure or personal injury due to the unexpected start of fan.</li> <li>• <b>Stop the compressor before disconnecting refrigerant pipes in case of pump down operation.</b> If disconnecting refrigerant pipes in state of opening operation valves before compressor stopping, air can be sucked, which can cause burst or personal injury due to anomalously high pressure in the refrigerant circuit</li> <li>• <b>Only use prescribed optional parts. The installation must be carried out by the qualified installer.</b> If you install the system by yourself, it can cause serious trouble such as water leaks, electric shocks, fire.</li> </ul>
<p></p> <ul style="list-style-type: none"> <li>• <b>Ensure that no air enters in the refrigerant circuit when the unit is installed and removed.</b> If air enters in the refrigerant circuit, the pressure in the refrigerant circuit becomes too high, which can cause burst and personal injury.</li> <li>• <b>Do not processing, splice the power cord, or share a socket with other power plugs.</b> This may cause fire or electric shock due to defecting contact, defecting insulation and over-current etc.</li> </ul>	<ul style="list-style-type: none"> <li>• <b>Do not bundling, winding or processing for the power cord. Or, do not deforming the power plug due to tread it.</b> This may cause fire or heating.</li> <li>• <b>Do not run the unit with removed panels or protections.</b> Touching rotating equipments, hot surfaces or high voltage parts can cause personal injury due to entrapment, burn or electric shocks.</li> </ul>	<ul style="list-style-type: none"> <li>• <b>Do not perform any change of protective device itself or its setup condition.</b> The forced operation by short-circuiting protective device of pressure switch and temperature controller or the use of non specified component can cause fire or burst.</li> </ul>
<p></p> <ul style="list-style-type: none"> <li>• <b>Carry out the electrical work for ground lead with care.</b> Do not connect the ground lead to the gas line, water line, lightning conductor or telephone line's ground lead. Incorrect grounding can cause unit faults such as electric shocks due to short-circuiting.</li> </ul>		

**CAUTION**

<p></p> <ul style="list-style-type: none"> <li>• <b>Use the circuit breaker with sufficient breaking capacity.</b> If the breaker does not have sufficient breaking capacity, it can cause the unit malfunction and fire.</li> <li>• <b>Earth leakage breaker must be installed.</b> If the earth leakage breaker is not installed, it can cause electric shocks.</li> <li>• <b>Install isolator or disconnect switch on the power supply wiring in accordance with the local codes and regulations.</b></li> <li>• <b>After maintenance, all wiring, wiring ties and the like, should be returned to their original state and wiring route, and the necessary clearance from all metal parts should be secured.</b></li> <li>• <b>Secure a space for installation, inspection and maintenance specified in the manual.</b> Insufficient space can result in accident such as personal injury due to falling from the installation place.</li> </ul>	<ul style="list-style-type: none"> <li>• <b>Take care when carrying the unit by hand.</b> If the unit weights more than 20kg, it must be carried by two or more persons. Do not carry by the plastic straps, always use the carry handle when carrying the unit by hand. Use gloves to minimize the risk of cuts by the aluminum fins.</li> <li>• <b>Dispose of any packing materials correctly.</b> Any remaining packing materials can cause personal injury as it contains nails and wood. And to avoid danger of suffocation, be sure to keep the plastic wrapper away from children and to dispose after tear it up.</li> <li>• <b>Be sure to insulate the refrigerant pipes so as not to condense the ambient air moisture on them.</b> Insufficient insulation can cause condensation, which can lead to moisture damage on the ceiling, floor, furniture and any other valuables.</li> </ul>	<ul style="list-style-type: none"> <li>• <b>When perform the air conditioner operation (cooling or drying operation) in which ventilator is installed in the room. In this case, using the air conditioner in parallel with the ventilator, there is the possibility that drain water may backflow in accordance with the room lapse into the negative pressure status. Therefore, set up the opening port such as incorporate the air into the room that may appropriate to ventilation (For example; Open the door a little). In addition, just as above, so set up the opening port if the room lapse into negative pressure status due to register of the wind for the high rise apartment etc.</b></li> </ul>
<p></p> <ul style="list-style-type: none"> <li>• <b>Do not install the unit in the locations listed below.</b> <ul style="list-style-type: none"> <li>• Locations where carbon fiber, metal powder or any powder is floating.</li> <li>• Locations where any substances that can affect the unit such as sulphide gas, chloride gas, acid and alkaline can occur.</li> <li>• Vehicles and ships.</li> <li>• Locations where cosmetic or special sprays are often used.</li> <li>• Locations with direct exposure of oil mist and steam such as kitchen and machine plant.</li> <li>• Locations where any machines which generate high frequency harmonics are used.</li> <li>• Locations with salty atmospheres such as coastlines.</li> <li>• Locations with heavy snow (If installed, be sure to provide</li> </ul> </li> </ul>	<ul style="list-style-type: none"> <li>• base flame and snow hood mentioned in the manual).</li> <li>• Locations where the unit is exposed to chimney smoke.</li> <li>• Locations at high altitude (more than 1000m high).</li> <li>• Locations with ammonic atmospheres.</li> <li>• Locations where heat radiation from other heat source can affect the unit.</li> <li>• Locations without good air circulation.</li> <li>• Locations with any obstacles which can prevent inlet and outlet air of the unit.</li> <li>• Locations where short circuit of air can occur (in case of multiple units installation).</li> <li>• Locations where strong air blows against the air outlet of outdoor unit.</li> </ul> <p>It can cause remarkable decrease in performance, corrosion and damage of components, malfunction and fire.</p>	<ul style="list-style-type: none"> <li>• <b>Do not install the outdoor unit in the locations listed below.</b> <ul style="list-style-type: none"> <li>• Locations where discharged hot air or operating sound of the outdoor unit can bother neighborhood.</li> <li>• Locations where outlet air of the outdoor unit blows directly to plants.</li> <li>• Locations where vibration can be amplified and transmitted due to insufficient strength of structure.</li> <li>• Locations where vibration and operation sound generated by the outdoor unit can affect seriously (on the wall or at the place near bed room).</li> <li>• Locations where an equipment affected by high harmonics is placed (TV set or radio receiver is placed within 1m).</li> <li>• Locations where drainage cannot run off safely. It can affect surrounding environment and cause a claim.</li> </ul> </li> </ul>

**⚠ CAUTION**

Все каталоги и инструкции здесь: <http://splitoff.ru/tehn-doc.html>

- Do not install the unit where corrosive gas (such as sulfurous acid gas etc.) or combustible gas (such as thinner and petroleum gases) can accumulate or collect, or where volatile combustible substances are handled.
- Corrosive gas can cause corrosion of heat exchanger, breakage of plastic parts and etc. And combustible gas can cause fire.
- Do not install nor use the system close to the equipment that generates electromagnetic fields or high frequency harmonics.
- Equipment such as inverters, standby generators, medical high frequency equipments and telecommunication equipments can affect the system, and cause malfunctions

- insects and small animals can inhabit.
- Insects and small animals can enter the electric parts and cause damage or fire. Instruct the user to keep the surroundings clean.
- Do not use the base flange for outdoor unit which is corroded or damaged due to long periods of operation.
- Using an old and damage base flange can cause the unit falling down and cause personal injury.
- Do not use any materials other than a fuse with the correct rating in the location where fuses are to be used.
- Connecting the circuit with copper wire or other metal thread can cause unit failure and fire.

- During operation the refrigerant pipes become extremely hot or extremely cold depending the operating condition, and it can cause burn injury or frost injury.
- Do not touch the suction or aluminum fin on the outdoor unit.
- This may cause injury.
- Do not put anything on the outdoor unit and operating unit.
- This may cause damage the objects or injury due to falling to the object.

**Check before installation work**

- Model name and power source
- Refrigerant piping length
- Piping, wiring and miscellaneous small parts
- Indoor unit installation manual

Accessories for outdoor unit	Q'ty
① Grommet (Heat pump type only)	2
② Drain elbow (Heat pump type only)	1
③ Variable diameter joint $\phi 9.52 \rightarrow \phi 12.7$	2

Note: Provide flare nuts when using the variable diameter joint (for  $\phi 12.7$ ).

Option parts	Q'ty	Necessary tools for the installation work	
① Sealing plate	1	1 Plus headed driver	9 Wrench key (Hexagon) (4m/m)
② Sleeve	1	2 Knife	10 Vacuum pump
③ Inclination plate	1	3 Saw	11 Vacuum pump adapter (Anti-reverse flow type) (Designed specifically for R410A)
④ Putty	1	4 Tape measure	12 Gauge manifold (Designed specifically for R410A)
⑤ Drain hose (extension hose)	1	5 Hammer	13 Charge hose (Designed specifically for R410A)
⑥ Piping cover (for insulation of connection piping)	1	6 Spanner wrench	14 Flaring tool set (Designed specifically for R410A)
		7 Torque wrench [14.0~62.0N·m (1.4~6.2kgf·m)]	15 Gas leak detector (Designed specifically for R410A)
		8 Hole core drill (65mm in diameter)	16 Gauge for projection adjustment (Used when flare is made by using conventional flare tool)

**CAUTION** • This model requires a minimum of 2 indoor units.

**1 SELECTION OF INSTALLATION LOCATION**

Install at location that meets the following conditions after getting approval from the customer.

- Where the following installation space is available, and where air does not gather.
- Where rain and sunlight do not directly hit the unit, and where there is enough air circulation.
- Also, where the unit cannot be buried by snow. a location which can sustain the weight of the unit, and where noises and vibrations are not enhanced.
- Where blasts of cold or hot air and noise do not bother the neighbors.
- Where the unit does not receive heat radiation from other heat sources.
- Where there are no obstructions (animals, plants, etc.) to the suction inlet and blowing outlet.
- Where water may drain out.
- ※ Please avoid the following locations.
  - Where there is constant exposure to harsh winds such as the top floors of a building. Also, locations with exposure to salty air.
  - Where there are oil splashes, vapor, and smoke.
  - Where there are possibilities of flammable gas leaks.

① Installation Space (on a flat surface)

- Blowing out port and suction port on the back side of the unit can be installed at a distance of 10cm from walls. (In case the barrier is 1.2m or above in height, or is overhead, the sufficient space between the unit and wall shall be secured.)
- When the unit is installed, the space of the following dimension and above shall be secured.

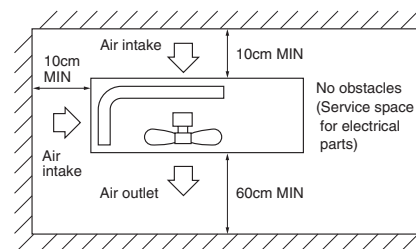

**Installation**

① Anchor bolt fixed position

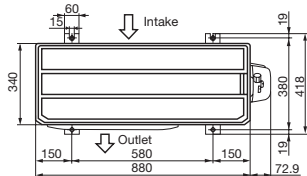

② Notabilia for installation

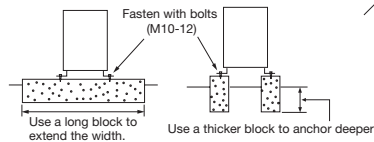

- In installing the unit, fix the unit's legs with bolts specified on the left.
- The protrusion of an anchor bolt on the front side must be kept within 15 mm.
- Securely install the unit so that it does not fall over during earthquakes or strong winds, etc.
- Refer to the above illustrations for information regarding concrete foundations.
- Install the unit in a level area. (With a gradient of 5 mm or less.)
- Improper installation can result in a compressor failure, broken piping within the unit and abnormal noise generation.

## 2 INSTALLATION OF OUTDOOR UNIT

### Drainage

- There are 3 holes in the bottom panel of the outdoor unit to drain condensation.
- Install the outdoor unit so it will be horizontal.

Все каталоги и инструкции здесь: <http://splitoff.ru/tehn-doc.html>

not install a drain elbow. (water discharge could stop due to freezing.)

Connection of the power supply cable and the connecting cables for indoor and outdoor units.

- This multi-type room air conditioner receives its power from outside.
- To ensure correct connections, mark each ends of the cables with number, A to D. It is important to use the same number the corresponding cables and pipes.
- An earth leakage breaker and a circuit breaker must be installed. Their capacities are 25A.

- ① Remove the service panel. (Remove the 2 sets screws of the service panel.)
- ② Remove the terminal cover. (Remove the 2 sets screws of the terminal cover.)
- ③ Connect the power supply cable and the connection wire securely to the terminal block.

[POWER SUPPLY CODE]  
CENELEC code for cables requiring fields cables. H05RNR3G4.0  
[INTERCONNECTING WIRING CODE]  
CENELEC code for cables requiring fields cables. H05RNR4G1.5

- 1) In wiring, make sure that the wire terminal numbers of outdoor unit terminal block are match to the wire terminal numbers of indoor unit terminal block.
- 2) Terminal number A of the outdoor unit is used for A indoor unit and terminal number B for B indoor unit respectively.
- ④ After connecting the wire, use wiring clamps to secure the wiring.
- ⑤ Fit the terminal cover and the service panel.

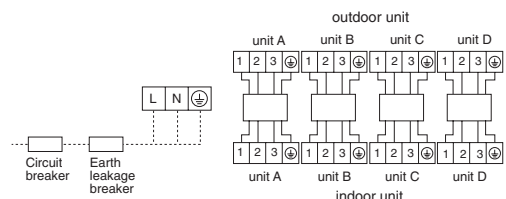
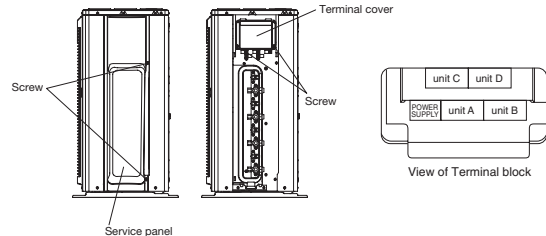

## 3 CONNECTION OF REFRIGERANT PIPINGS

- Regarding the change in the sizes of gas side pipes (usage of the variable joints); If a 5.0, 6.0 kw class indoor unit (gas side pipe 12.7) is going to be connected to the operation valves (9.52), variable joints available as accessories must be applied to the gas side operation valves.
- Securely fit the copper packing between the operation valve and the variable diameter joint to prevent shifting.

[Connection of pipes]

### NOTE

- Cover the pipes with tape so that dust and sand do not enter the pipe until they are connected.
- When connecting the pipes to the outdoor unit, be careful about the discharge of fluorocarbon gas or oil.
- Make sure to match the pipes between the indoor unit and the outdoor unit with the correct operation valves.

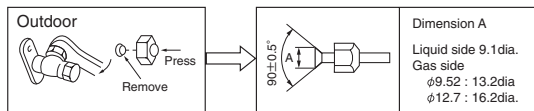

- Remove the flared nuts. (on both liquid and gas sides)
- Install the removed flared nuts to the pipes to be connected, then flare the pipes.

### CAUTION

Do not apply excess torque to the flared nuts. Otherwise, the flared nuts may crack depending on the conditions and refrigerant leak may occur.

### CAUTION

Do not apply refrigerating machine oil to the flared surface.

### Connection

#### Outdoor

Liquid side  
Gas side



- Connect the pipes on both liquid and gas sides.
- Tighten the nuts to the following torque.  
Liquid side : 14.0~18.0N·m (1.4~1.8kgf·m)  
Gas side (φ9.52): 33.0~42.0N·m (3.3~4.2kgf·m)  
Gas side (φ12.7): 49.0~61.0N·m (4.9~6.1kgf·m)

- When the total refrigerant pipe length for all the rooms exceeds the length of the uncharged pipe (40m), additional refrigerant is required. (If 40m or less, additional charge is not required.)  
Additional charge amount per meter = 20g/m

#### Gas Leakage Test

- Ensure that there are no gas leaks from the pipe joints by using a leak detector or soap water.

[Examples of use of variable diameter joints]

- Connection of indoor unit of Class 5.0 to A unit.

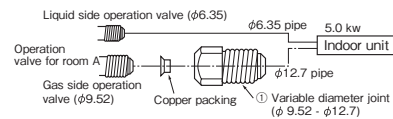

Copper pipe diameter	Measurement B (mm)		
	Clutch type flare tool for R410A	Conventional (R22) flare tool	
		Clutch type	Wing nut type
φ6.35	0.0~0.5	1.0~1.5	1.5~2.0
φ9.52	0.0~0.5	1.0~1.5	1.5~2.0
φ12.7	0.0~0.5	1.0~1.5	2.0~2.5

Use a flare tool designed for R410A or a conventional flare tool. Please note that measurement B (protrusion from the flaring block) will vary depending on the type of a flare tool in use.  
If a conventional flare tool is used, please use a copper pipe gauge or a similar instrument to check protrusion so that you can keep measurement B to a correct value.

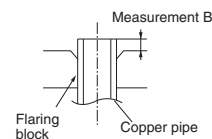

[Limit]

Limit	one indoor unit all indoor unit	MAX 25m MAX 70m
pipng length		
hight difference	MAX 20m MAX 25m	Indoor unit Indoor unit Indoor unit Indoor unit
length of chargeless refrigerant pipe		40m



**4 AIR PURGING**

NOTE : Fully open the operation valves (on both liquid and gas sides) after completing air purging.

- Since the system uses service ports differing in diameter from those found on the conventional models, a charge hose (for R22) presently in use is not applicable. Please use one designed specifically for R410A.
- Please use an anti-reverse flow type vacuum pump adapter so as to prevent vacuum pump oil from running back into the system. Oil running back into an air-conditioning system may cause the refrigerant cycle to break down.

Все каталоги и инструкции здесь: <http://splitoff.ru/tehn-doc.html>

**Procedure**

- (1) Secure all flare nuts on both indoor and outdoor sides to prevent leaks from the pipes.
- (2) Connect the operation valves, charge hose, manifold valve and vacuum pump as shown in the right figure.
- (3) Fully open the handle Lo for the manifold valve, and pump a vacuum for 15 minutes. Ensure that the meter is indicating -0.1MPa (-76cmHg).
- (4) After vacuuming, fully open the operation valve (both liquid and gas sides) with a hexagon wrench.

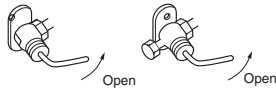

- (5) Remove the charge hose from service port.
- (6) Repeat the above steps (1) ~ (5) for all connected indoor units.
- (7) Ensure that there are no gas leaks from the joints in the indoor and outdoor units.

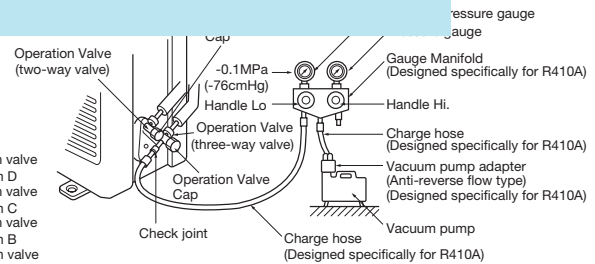
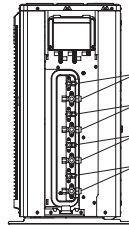

Securely tighten the operation valve cap and the check joint blind nut after adjustment.

Operation valve size (mm)	Operation valve cap tightening torque (N·m)	Check joint blind nut tightening torque (N·m)
φ6.35 (1/4")	20~30	10~12
φ9.52 (3/8")		
φ12.7 (1/2")	25~35	

**5 HEAT INSULATION FOR JOINTS**

Heat insulation for joints

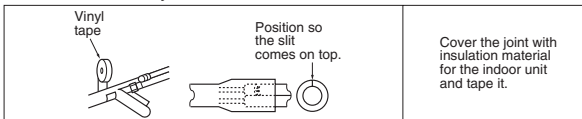

Finish and fixing

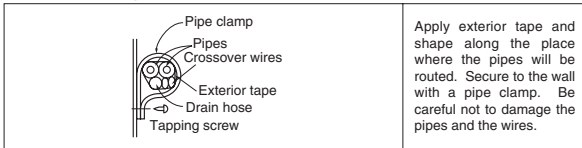

**7 BEWARE OF WRONG CONNECTIONS IN REFRIGERANT PIPING AND WIRING.**

- Make sure to match the piping and wiring from each unit to the outdoor unit.
- Be careful because if connections are wrong, normal operation cannot be achieved and may damage the compressor.

[Correct connections]

[Example of wrong connections]

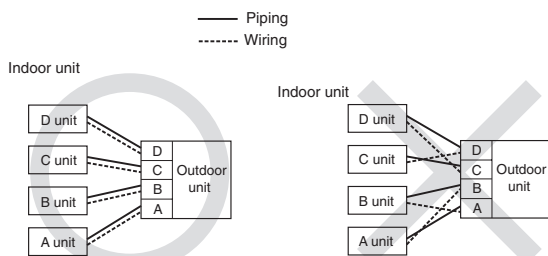

**EARTHING WORK**

- Earth work shall be carried out without fail in order to prevent electric shock and noise generation.
- The connection of the earth cable to the following substances causes dangerous failures, therefore it shall never be done. (City water pipe, Town gas pipe, TV antenna, lightning conductor, telephoneline, etc.)

**6 TEST RUN AND HANDLING INSTRUCTIONS**

**Installation test check points**

Check the following points again after completion of the installation, and before turning on the power.  
 Conduct a test run again and ensure that the unit operates properly.  
 At the same time, explain to the customer how to use the unit and how to take care of the unit following the installation manual.  
 If the compressor does not operate after the operation has started, wait for 5-10 minutes. (This may be due to delayed start.)  
 (Three-minute restart preventive timer)  
 When the air conditioner is restarted or when changing the operation, the unit will not start operating for approximately 3minutes. This is to protect the unit and it is not a malfunction.

**After installation**

- The power supply voltage is correct as the rating.
- No gas leaks from the joints of the operation valve.
- Power cables and crossover wires are securely fixed to the terminal board.
- Each indoor and outdoor unit is properly connected (no wrong wiring or piping).
- Operation valve is fully open.
- Refrigerant has been additionally charged (when the total pipe length exceeds the refrigerant charged pipe length).
- The pipe joints for indoor and outdoor pipes have been insulated.
- Earthing work has been conducted properly.

**Test run**

- Air conditioning and heating are normal.
- No abnormal noise.
- Water drains smoothly.
- Protective functions are not working.
- Operation of the unit has been explained to the customer.
- The remote control is normal.

**Operation of indicator lamps**

INDICATION LAMP	COLOR	FUNCTION
LED E (1)	RED	WARNING LAMP
SELF DIAGNOSIS FUNCTION BY LED E		
1 TIME FLASH		CURRENT CUT
2 TIME FLASH		TROUBLE OF OUTDOOR UNIT
3 TIME FLASH		OVER CURRENT
4 TIME FLASH		TRANSMISSION ERROR IN OUTDOOR UNIT PCB
5 TIME FLASH		OVER HEAT OF COMPRESSOR
6 TIME FLASH		ERROR OF SIGNAL TRANSMISSION
7 TIME FLASH		LOCK OF COMPRESSOR
8 TIME FLASH		SENSOR ERROR (EXCEPT DISCHARGE PIPE SENSOR)
LIGHT ON		OUTDOOR FAN MOTOR ERROR
FOUR SEC LIGHT AND FOUR SEC OFF		DISCHARGE PIPE SENSOR ERROR

## 5.2 Installation of Indoor unit

### (1) Wall mounted type (SRK)

#### (a) Models SRK20ZJX-S, 25ZJX-S, 35ZJX-S, 50ZJX-S, 60ZJX-S



- This instruction manual illustrates the method of installing an indoor unit.
- For electrical wiring work, please see instructions set out on the backside.
- For outdoor unit installation and refrigerant piping, please refer to page 127 and 138.

- A wired remote control unit is supplied separately as an optional part.
- When install the unit, be sure to check whether the selection of installation place, power supply specifications, usage limitation (piping length, height differences between indoor and outdoor units, power supply voltage and etc.) and installation spaces.

### SAFETY PRECAUTIONS

- We recommend you to read this "SAFETY PRECAUTIONS" carefully before the installation work in order to gain full advantage of the functions of the unit and to avoid malfunction due to mishandling.
- The precautions described below are divided into **⚠ WARNING** and **⚠ CAUTION**. The matters with possibilities leading to serious consequences such as death or serious personal injury due to erroneous handling are listed in the **⚠ WARNING** and the matters with possibilities leading to personal injury or damage of the unit due to erroneous handling including probability leading to serious consequences in some cases are listed in **⚠ CAUTION**. These are very important precautions for safety. Be sure to observe all of them without fail.
- Be sure to confirm no anomaly on the equipment by commissioning after completed installation and explain the operating methods as well as the maintenance methods of this equipment to the user according to the owner's manual.

- Keep the installation manual together with owner's manual at a place where any user can read at any time. Moreover if necessary, ask to hand them to a new user.
- For installing qualified personnel, take precautions in respect to themselves by using suitable protective clothing, gloves, etc., and then perform the installation works.
- Please pay attention not to fall down the tools, etc. when installing the unit at the high position.
- If unusual noise can be heard during operation, consult the dealer.
- Symbols which appear frequently in the text have the following meaning:

 Observe instructions with great care	 Strictly prohibited	 Provide proper earthing
--	---	--

### ⚠ WARNING

- |  |   |
|--|---|
| <ul style="list-style-type: none"> <li>• <b>Installation must be carried out by the qualified installer.</b><br/>If you install the system by yourself, it may cause serious trouble such as water leaks, electric shocks, fire and personal injury, as a result of a system malfunction.</li> <li>• <b>Install the system in full accordance with the instruction manual.</b><br/>Incorrect installation may cause bursts, personal injury, water leaks, electric shocks and fire.</li> <li>• <b>Be sure to use only for household and residence.</b><br/>If this appliance is installed in inferior environment such as machine shop and etc., it can cause malfunction.</li> <li>• <b>Use the original accessories and the specified components for installation.</b><br/>If parts other than those prescribed by us are used, it may cause water leaks, electric shocks, fire and personal injury.</li> <li>• <b>Install the unit in a location with good support.</b><br/>Unsuitable installation locations can cause the unit to fall and cause material damage and personal injury.</li> <li>• <b>Ventilate the working area well in the event of refrigerant leakage during installation.</b><br/>If the refrigerant comes into contact with naked flames, poisonous gas is produced.</li> <li>• <b>When installing in small rooms, take prevention measures not to exceed the density limit of refrigerant in the event of leakage.</b><br/>Consult the expert about prevention measures. If the density of refrigerant exceeds the limit in the event of leakage, lack of oxygen can occur, which can cause serious accidents.</li> <li>• <b>After completed installation, check that no refrigerant leaks from the system.</b><br/>If refrigerant leaks into the room and comes into contact with an oven or other hot surface, poisonous gas is produced.</li> <li>• <b>Use the prescribed pipes, flare nuts and tools for R410A.</b><br/>Using existing parts (for R22 or R407C) can cause the unit failure and serious accidents due to burst of the refrigerant circuit.</li> </ul> | <ul style="list-style-type: none"> <li>• <b>Tighten the flare nut by torque wrench with specified method.</b><br/>If the flare nut were tightened with excess torque, this may cause burst and refrigerant leakage after a long period.</li> <li>• <b>The electrical installation must be carried out by the qualified electrician in accordance with "the norm for electrical work" and "national wiring regulation", and the system must be connected to the dedicated circuit.</b><br/>Power supply with insufficient capacity and incorrect function done by improper work can cause electric shocks and fire.</li> <li>• <b>Be sure to shut off the power before starting electrical work.</b><br/>Failure to shut off the power can cause electric shocks, unit failure or incorrect function of equipment.</li> <li>• <b>Be sure to use the cables conformed to safety standard and cable ampacity for power distribution work.</b><br/>Unconformable cables can cause electric leak, anomalous heat production or fire.</li> <li>• <b>This appliance must be connected to main power supply by means of a circuit breaker or switch (fuse:16A) with a contact separation of at least 3mm.</b></li> <li>• <b>When plugging this appliance, a plug conforming to the norm IEC60884-1 must be used.</b></li> <li>• <b>Use the prescribed cables for electrical connection, tighten the cables securely in terminal block and relieve the cables correctly to prevent overloading the terminal blocks.</b><br/>Loose connections or cable mountings can cause anomalous heat production or fire.</li> <li>• <b>Arrange the wiring in the control box so that it cannot be pushed up further into the box. Install the service panel correctly.</b><br/>Incorrect installation may result in overheating and fire.</li> <li>• <b>Be sure to switch off the power supply in the event of installation, inspection or servicing.</b><br/>If the power supply is not shut off, there is a risk of electric shocks, unit failure or personal injury due to the unexpected start of fan.</li> </ul> |
| <ul style="list-style-type: none"> <li>• <b>Do not put the drainage pipe directly into drainage channels where poisonous gases such as sulphide gas can occur.</b><br/>Poisonous gases will flow into the room through drainage pipe and seriously affect the user's health and safety.</li> <li>• <b>Ensure that no air enters in the refrigerant circuit when the unit is installed and removed.</b><br/>If air enters in the refrigerant circuit, the pressure in the refrigerant circuit becomes too high, which can cause burst and personal injury.</li> </ul>   | <ul style="list-style-type: none"> <li>• <b>Do not processing, splice the power cord, or share a socket with other power plugs.</b><br/>This may cause fire or electric shock due to defecting contact, defecting insulation and over-current etc.</li> <li>• <b>Do not bundling, winding or processing for the power cord. Or, do not deforming the power plug due to treat it.</b><br/>This may cause fire or heating.</li> </ul>   |

RKY012A007A

### ⚠ WARNING

- |  |  |
|--|--|
| <ul style="list-style-type: none"> <li>• <b>Do not vent R410A into the atmosphere : R410A is a fluorinated greenhouse gas, covered by the Kyoto Protocol with Global Warming Potential (GWP)=1975.</b></li> <li>• <b>Do not run the unit with removed panels or protections.</b><br/>Touching rotating equipments, hot surfaces or high voltage parts can cause personal injury due to entrapment, burn or electric shocks.</li> </ul> | <ul style="list-style-type: none"> <li>• <b>Do not perform any change of protective device itself or its setup condition.</b><br/>The forced operation by short-circuiting protective device of pressure switch and temperature controller or the use of non specified component can cause fire or burst.</li> </ul> |
| <ul style="list-style-type: none"> <li>• <b>Carry out the electrical work for ground lead with care.</b><br/>Do not connect the ground lead to the gas line, water line, lightning conductor or telephone line's ground lead. Incorrect grounding can cause unit faults such as electric shocks due to short-circuiting.</li> </ul>  |  |

### ⚠ CAUTION

- |  |   |
|--|---|
| <ul style="list-style-type: none"> <li>• <b>Use the circuit breaker with sufficient breaking capacity.</b><br/>If the breaker does not have sufficient breaking capacity, it can cause the unit malfunction and fire.</li> <li>• <b>Earth leakage breaker must be installed.</b><br/>If the earth leakage breaker is not installed, it can cause electric shocks.</li> <li>• <b>Install isolator or disconnect switch on the power supply wiring in accordance with the local codes and regulations.</b></li> <li>• <b>Be sure to install indoor unit properly according to the instruction manual in order to run off the drainage smoothly.</b><br/>Improper installation of indoor unit can cause dropping water into the room and damaging personal property.</li> <li>• <b>Install the drainage pipe to run off drainage securely according to the installation manual.</b><br/>Incorrect installation of the drainage pipe can cause dropping water into the room and damaging personal property.</li> <li>• <b>Be sure to install the drainage pipe with descending slope of 1/100 or more, and not to make traps and air-bleedings.</b><br/>Check if the drainage runs off securely during commissioning and ensure the space for inspection and maintenance.</li> </ul> | <ul style="list-style-type: none"> <li>• <b>Secure a space for installation, inspection and maintenance specified in the manual.</b><br/>Insufficient space can result in accident such as personal injury due to falling from the installation place.</li> <li>• <b>For installation work, be careful not to get injured with the heat exchanger, piping flare portion or screws etc.</b></li> <li>• <b>Be sure to insulate the refrigerant pipes so as not to condense the ambient air moisture on them.</b><br/>Insufficient insulation can cause condensation, which can lead to moisture damage on the ceiling, floor, furniture and any other valuables.</li> <li>• <b>When perform the air conditioner operation (cooling or drying operation) in which ventilator is installed in the room. In this case, using the air conditioner in parallel with the ventilator, there is the possibility that drain water may backflow in accordance with the room lapse into the negative pressure status. Therefore, set up the opening port such as incorporate the air into the room that may appropriate to ventilation (For example; Open the door a little). In addition, just as above, so set up the opening port if the room lapse into negative pressure status due to register of the wind for the high rise apartment etc.</b></li> </ul> |
|--|---|

- |   |  |
|---|--|
| <ul style="list-style-type: none"> <li>• <b>Do not install the unit in the locations listed below.</b> <ul style="list-style-type: none"> <li>• Locations where carbon fiber, metal powder or any powder is floating.</li> <li>• Locations where any substances that can affect the unit such as sulphide gas, chloride gas, acid and alkaline can occur.</li> <li>• Vehicles and ships.</li> <li>• Locations where cosmetic or special sprays are often used.</li> <li>• Locations with direct exposure of oil mist and steam such as kitchen and machine plant.</li> <li>• Locations where any machines which generate high frequency harmonics are used.</li> <li>• Locations with salty atmospheres such as coastlines.</li> <li>• Locations with heavy snow (If installed, be sure to provide base flame and snow hood mentioned in the manual).</li> <li>• Locations where the unit is exposed to chimney smoke.</li> <li>• Locations at high altitude (more than 1000m high).</li> <li>• Locations with ammoniac atmospheres.</li> <li>• Locations where heat radiation from other heat source can affect the unit.</li> <li>• Locations without good air circulation.</li> <li>• Locations with any obstacles which can prevent inlet and outlet air of the unit.</li> <li>• Locations where short circuit of air can occur (in case of multiple units installation).</li> <li>• Locations where strong air blows against the air outlet of outdoor unit. It can cause remarkable decrease in performance, corrosion and damage of components, malfunction and fire.</li> </ul> </li> <li>• <b>Do not install the indoor unit in the locations listed below (Be sure to install the indoor unit according to the installation manual for each model because each indoor unit has each limitation).</b> <ul style="list-style-type: none"> <li>• Locations with any obstacles which can prevent inlet and outlet air of the unit.</li> <li>• Locations where vibration can be amplified due to insufficient strength of structure.</li> <li>• Locations where the infrared receiver is exposed to the direct sunlight or the strong light beam (in case of the infrared specification unit).</li> <li>• Locations where (an equipment affected by high harmonics is placed (TV set or radio receiver is placed within 5m).</li> <li>• Locations where drainage cannot run off safely. It can affect performance or function and etc.</li> </ul> </li> <li>• <b>Do not install the unit near the location where leakage of combustible gases can occur.</b><br/>If leaked gases accumulate around the unit, it can cause fire.</li> </ul> | <ul style="list-style-type: none"> <li>• <b>Do not install the unit where corrosive gas (such as sulfurous acid gas etc.) or combustible gas (such as thinner and petroleum gases) can accumulate or collect, or where volatile combustible substances are handled.</b><br/>Corrosive gas can cause corrosion of heat exchanger, breakage of plastic parts and etc. And combustible gas can cause fire.</li> <li>• <b>Do not use the indoor unit at the place where water splashes may occur such as in laundries.</b><br/>Since the indoor unit is not waterproof, it can cause electric shocks and fire.</li> <li>• <b>Do not install nor use the system close to the equipment that generates electromagnetic fields or high frequency harmonics.</b><br/>Equipment such as inverters, standby generators, medical high frequency equipments and telecommunication equipments can affect the system, and cause malfunctions and breakdowns. The system can also affect medical equipment and telecommunication equipment, and obstruct its function or cause jamming.</li> <li>• <b>Do not place any variables which will be damaged by getting wet under the indoor unit.</b><br/>When the relative humidity is higher than 80% or drainage pipe is clogged, condensation or drainage water can drop and it can cause the damage of valuables.</li> <li>• <b>Do not install the remote control at the direct sunlight.</b><br/>It can cause malfunction or deformation of the remote control.</li> <li>• <b>Do not use the unit for special purposes such as storing foods, cooling precision instruments and preservation of animals, plants or art.</b><br/>It can cause the damage of the items.</li> <li>• <b>Do not use any materials other than a fuse with the correct rating in the location where fuses are to be used.</b><br/>Connecting the circuit with copper wire or other metal thread can cause unit failure and fire.</li> <li>• <b>Do not touch any buttons with wet hands.</b><br/>It can cause electric shocks.</li> <li>• <b>Do not touch any refrigerant pipes with your hands when the system is in operation.</b><br/>During operation the refrigerant pipes become extremely hot or extremely cold depending the operating condition, and it can cause burn injury or frost injury.</li> </ul> |
|---|--|

## BEFORE INSTALLATION

○ Before installation check that the power supply matches the air conditioner.

Standard accessories (Installation kit) Accessories for indoor unit		Q'ty
①	Installation board (Attached to the rear of the indoor unit)	1
②	Wireless remote control	1
③	Remote control holder	1
④	Tapping screws (for installation board 4dia. by 25mm)	4
⑤	Wood screw (for remote control switch holder 3.5(mm), by 16mm)	2
⑥	Battery [R03(AAA, Micro) 1.5V]	2
⑦	Air-cleaning filters	2
⑧	Filter holders (Attached to the front panel of indoor unit)	2
⑨	Insulation (#486 50 x 100 t3)	1

Option parts		Q'ty
Ⓐ	Sealing plate	1
Ⓑ	Sleeve	1
Ⓒ	Incination plate	1
Ⓓ	Putty	1
Ⓔ	Drain hose (extention hose)	1
①	Piping cover (for insulation of connection piping)	1

Necessary tools for the installation work	
1	Plus headed driver
2	Knife
3	Saw
4	Tape measure
5	Hammer
6	Spanner wrench
7	Torque wrench (14.0 ~ 61.0N·m (1.4 ~ 6.1kgf·m))
8	Hole core drill (65mm in diameter)
9	Wrench key (Hexagon) [4m/m]
10	Flaring tool set (Designed specifically for R410A)
11	Gas leak detector (Designed specifically for R410A)
12	Gauge for projection adjustment (Used when flare is made by using conventional flare tool)
13	Pipe bender

## SELECTION OF INSTALLATION LOCATION

(Install at location that meets the following conditions, after getting approval from the customer)

### Indoor unit

- Where there is no obstructions to the air flow and where the cooled and heated air can be evenly distributed.
- A solid place where the unit or the wall will not vibrate.
- A place where there will be enough space for servicing. (Where space mentioned below can be secured)
- Where wiring and the piping work will be easy to conduct.
- The place where receiving part is not exposed to the direct rays of the sun or the strong rays of the street lighting.
- A place where it can be easily drained.
- A place separated at least 1m away from the television or the radio. (To prevent interference to images and sounds.)
- Places where this unit is not affected by the high frequency equipment or electric equipment.
- Avoid installing this unit in place where there is much oil mist.
- Places where there is no electric equipment or household under the installing unit.

### Wireless remote control

- A place where the air conditioner can be received the signal surely during operating the wireless remote control.
- Places where there is no affected by the TV and radio etc.
- Do not place where exposed to direct sunlight or near heat devices such as a stove.

### CAUTION

Completely seal the hole on the wall with putty. Otherwise, furniture, or other, may be wetted by leaked water or dewing.



## INSTALLATION OF INDOOR UNIT

### Installation of Installation board

Look for the inside wall structures (Intersediats support or pillar and finally install the unit after level surface has been checked.)

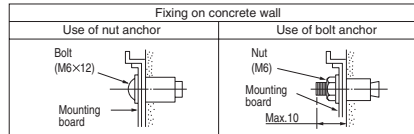
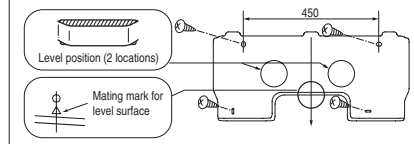

### Drilling of holes and fixture of sleeve (Option parts)

When drilling the wall that contains a metal lath, wire lath or metal plate, be sure to use pipe hole sleeve sold separately.

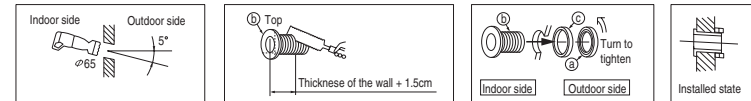

○ Drill a hole with whole core drill.

○ In case of rear piping draw out, cut off the lower and the right side portions of the sleeve collar.

### Installing the support of piping

#### In case of piping in the right rear direction

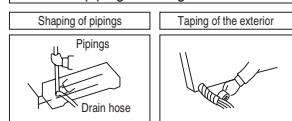

○ Hold the bottom of the piping and fix direction before stretching it and shaping it.

○ Tape only the portion that goes through the wall.  
○ Always tape the wiring with the piping.

Sufficient care must be taken not to damage the panel when connecting pipes.

● Matters of special notice when piping from left or central/rear of the unit.

[Top view]

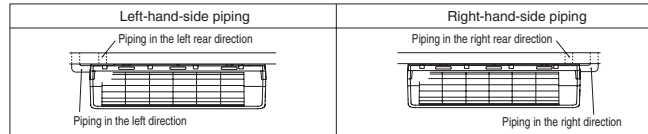

#### [Drain hose changing procedures]

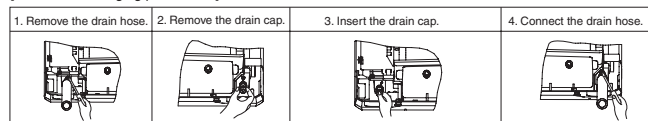

○ Remove the screw and drain hose, making it rotate.

○ Remove it with hand or pliers.

○ Insert the drain cap which was removed at procedure "2" securely using a hexagonal wrench etc.  
Note: Be careful that if it is not inserted securely, water leakage may occur.

○ Insert the drain hose securely, making rotate. And install the screw.  
Note: Be careful that if it is not inserted securely, water leakage may occur.

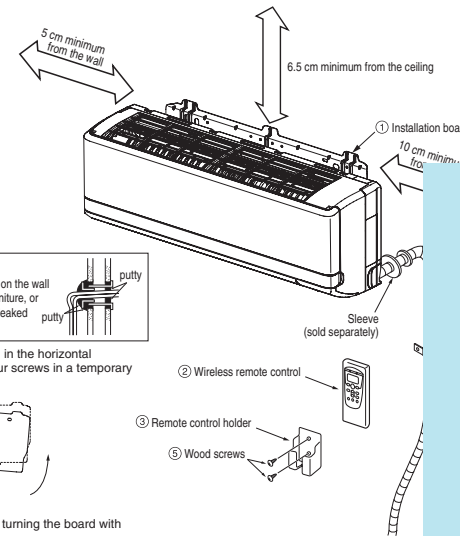

### Relation between setting plate and indoor unit

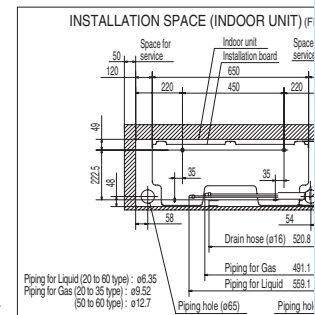

Piping is possible in left rear, left downward direction

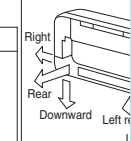

### Fixing of indoor unit

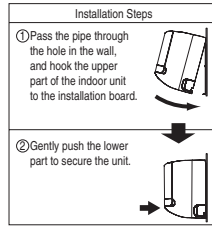
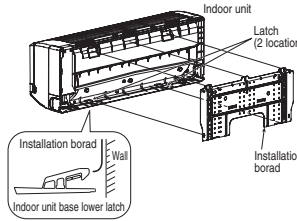

### How to remove the indoor unit from the installation board

- Push up at the marked portion of the indoor unit base lower latch, and slightly pull it toward you. (both right and left hand sides) (The indoor unit base lower latch can be removed from the installation board)
- Push up the indoor unit upward. So the indoor unit will be removed from the installation board.

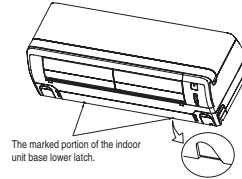

Since this air conditioner has been designed to collect dew drops on the rear surface to the drain pan, do not attach the power cord above the gutter.

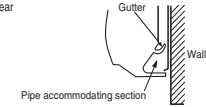

### Drainage

- Arrange the drain hose in a downward angle
  - Avoid the following drain piping.
- CAUTION** Go through all installation steps and check if the drainage is all right. Otherwise water leak may occur.

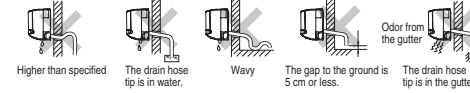

- Pour water to the drain pan located under the heat exchanger, and ensure that the water is discharged outdoor.
- When the extended drain hose is indoor, always use a shield pipe (to be arranged by the user) and ensure it is thermally insulated

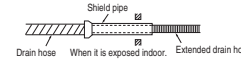

## CONNECTION OF REFRIGERANT PIPINGS

**Preparation** Keep the openings of the pipes covered with tapes etc. to prevent dust, sand, etc. from entering them.

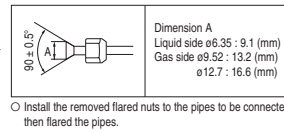
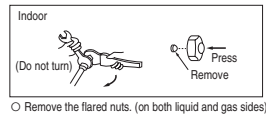

**CAUTION**  
Do not apply refrigerating machine oil to the flared surface.

### Flaring work

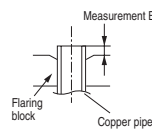

Copper pipe diameter	Clutch type flare tool for R410A	Measurement B (mm)	
		Conventional (R22) flare tool Clutch type	Wing nut type
ø6.35	0.0 - 0.5	1.0 - 1.5	1.5 - 2.0
ø9.52	0.0 - 0.5	1.0 - 1.5	1.5 - 2.0
ø12.7	0.0 - 0.5	1.0 - 1.5	2.0 - 2.5

Use a flare tool designed for R410A or a conventional flare tool.  
Please note that measurement B (protrusion from the flaring block) will vary depending on the type of a flare tool in use.  
If a conventional flare tool is used, please use a copper pipe gauge or a similar instrument to check protrusion so that you can keep measurement B to a correct value.

**CAUTION**  
Do not apply excess torque to the flared nuts. Otherwise, the flared nuts may checkdepending.

### Connection

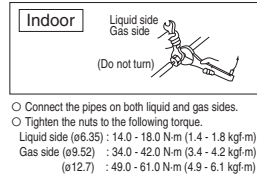

### Insulation of the connection portion

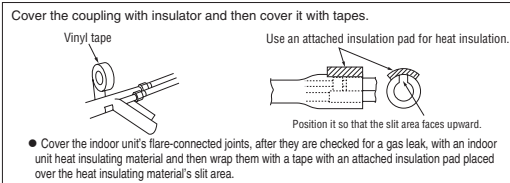

### Finishing work and fixing

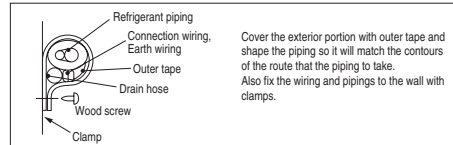

### Open/close and detachment/attachment of the air inlet panel

- To open, pull the panel at both ends of lower part and release latches, then pull up the panel until you feel resistance. (The panel stops at approx. 60° open position)
- To close, hold the panel at both ends of lower part to lower downward and push it slightly until the latch works.
- To remove, pull up the panel to the position shown in right illustration and pull it toward you.
- To install, insert the panel arm into the slot on the front panel from the position shown in right illustration, hold the panel at both ends of lower part, lower it downward slowly, then push it slightly until the latch works.

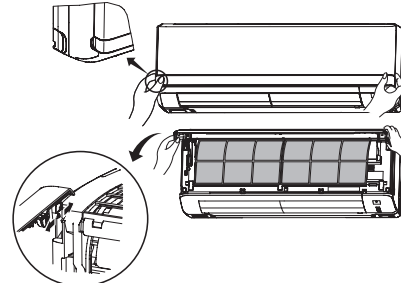

### How to remove and fit the front panel

- Removing
  - Remove the air inlet panel.
  - Remove the 5 set screws.
  - Remove the 4 latches in the upper section.
  - Move the lower part of the panel forward and push upwards to remove.
- Fitting
  - Do remove the air filter.
  - Cover the body with the front panel.
  - Fit the 4 latches in the upper section.
  - Tighten the 5 set screws.
  - Fit the air filter.
  - Fit the air inlet panel.

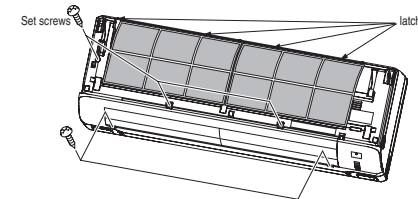

## ELECTRICAL WIRING WORK

### Preparation of indoor unit

#### Mounting of connecting wires

- ① Open the air inlet panel.
- ② Remove the service panel.
- ③ Remove the wiring clamp
- ④ Connect the connecting wire securely to the terminal block.
  - 1) Connect the connection wire securely to the terminal block. If the wire is not affixed completely, contact will be poor, and it is dangerous as the terminal block may heat up and catch fire.
  - 2) Take care not to confuse the terminal numbers for indoor and outdoor connections.
  - 3) Fix the connection wire using the wiring clamp.
- ⑤ Fix the connecting wire by wiring clamp.
- ⑥ Attach the service panel.
- ⑦ Close the air inlet panel.

#### CAUTION

In case of faulty wiring connection, the indoor unit stops, and then the run lamp turns on and the timer lamp blinks.

Use cables for interconnection wiring to avoid loosening of the wires.  
CENELEC code for cables Required field cables.

H05RN4G1.5 (example) or 245IEC57  
 H Harmonized cable type  
 05 300/500 volts  
 R Natural-and/or synth. rubber wire insulation  
 N Polychloroprene rubber conductors insulation  
 R Stranded core  
 4or5 Number of conductors  
 G One conductor of the cable is the earth conductor (yellow/green)  
 1.5 Section of copper wire (mm<sup>2</sup>)

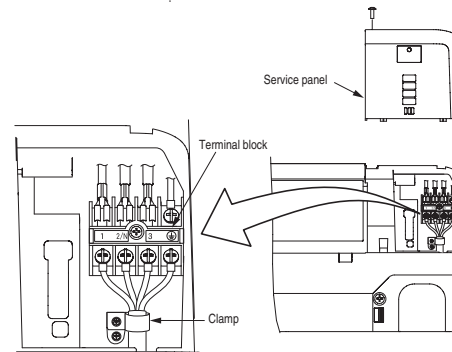

### Installing the air-cleaning filters

1. Open the air inlet panel and remove the air filters.
2. Install the filter holders, with the air-cleaning filters installed in the holders. In the air conditioner.
  - Each air-cleaning filter can be installed in the left or right filter holder.
3. Install the air filters and close the inlet panel.

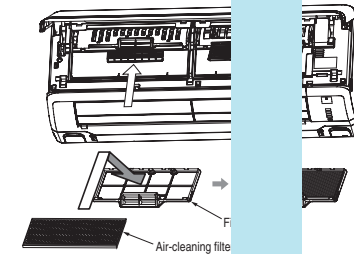

## INSTALLATION OF REMOTE CONTROL SWITCH

### Mounting method of battery

- Uncover the wireless remote control, and mount the batteries [R03(AAA, Micro), ×2 pieces] in the body regularly. (Fit the poles with the indication marks, ⊕ & ⊖ without fall)

#### CAUTION

Do not use new and old batteries together.

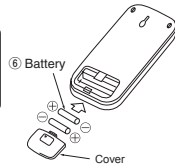

### Fixing to pillar or wall

- Conventionally, operate the remote control switch by holding in your hand.
- Avoid installing it on a clay wall etc.

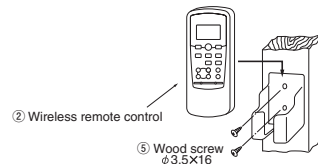

## INSTALLATION TEST CHECK POINTS

Check the following points again after completion of the installation, and before turning on the power. Conduct a test run again and explain to the customer how to use the unit and how to take care of the unit following the user's manual.

#### After installation

- The power supply voltage is correct as the rating.
- No gas leaks from the joints of the operational valve.
- Power cables and crossover wires are securely fixed to the terminal board.
- Operational valve is fully open.
- The pipe joints for indoor and outdoor pipes have been insulated.

#### Test run

- Air conditioning operation is normal.
- No abnormal noise.
- Water drains smoothly.
- Protective functions are not working.
- The remote control is normal.
- Operation of the unit has been explained to the customer. (Three-minutes restart preventive timer)  
When the air conditioner is restarted or when the power is turned on, the unit will not start operating for approximately 3 minutes. This is to protect the unit and it is not a malfunction.

## HOW TO RELOCATE OR DISPOSE OF THE UNIT

- In order to protect the environment, be sure to pump down (recovery of refrigerant).
- Pump down is the method of recovering refrigerant from the indoor unit to the outdoor unit when the pipes are removed from the unit.

<How to pump down>

- ① Connect charge hose to service port of outdoor unit.
- ② Liquid side : Close the liquid valve with hexagon wrench key.  
Gas side : Fully open the gas valve  
Carry out cooling operation. (If indoor temperature is low, operate forced cooling operation.)
- ③ After low pressure gauge become 0.01MPa, stop cooling operation and close the gas valve.



Unit ON/OFF button

#### Forced cooling operation

Turn on a power supply again after a while after turn off a power supply. Then press continually the ON/OFF button 5 seconds or more.

## CONCERNING TERMINAL CONNECTION FOR AN INTERFACE

- ① Remove the front panel and lid of control.
- ② There is a terminal (respectively marked with CNS) for the indoor control board. In connecting an interface, connect to the respective terminal securely with the connection harness supplied with an optional "Interface connection kit SC-BIKN-E" and fasten the connection harness onto the indoor control box with the clamp supplied with the kit. For more details, please refer to the user's manual of your "Interface connection kit SC-BIKN-E".



(a) Models SRK20ZJ-S, 25ZJ-S, 35ZJ-S, 50ZJ-S

RLA012A012

- This instruction manual illustrates the method of installing an indoor unit.
- For outdoor unit installation and refrigerant piping, please refer to page 127 and 138.
- A wired remote control unit is supplied separately as an optional part.

- When install the unit, be sure to check whether the selection of installation place, power supply specifications, usage limitation (piping length, height differences between indoor and outdoor units, power supply voltage and etc.) and installation spaces.

**SAFETY PRECAUTIONS**

- We recommend you to read this "SAFETY PRECAUTIONS" carefully before the installation work in order to gain full advantage of the functions of the unit and to avoid malfunction due to mishandling.
- The precautions described below are divided into **WARNING** and **CAUTION**. The matters with possibilities leading to serious consequences such as death or serious personal injury due to erroneous handling are listed in the **WARNING** and the matters with possibilities leading to personal injury or damage of the unit due to erroneous handling including probability leading to serious consequences in some cases are listed in **CAUTION**. These are very important precautions for safety. Be sure to observe all of them without fail.
- Be sure to confirm no anomaly on the equipment by commissioning after completed installation and explain the operating methods as well as the maintenance methods of this equipment to the user according to the owner's manual.

- Keep the installation manual together with owner's manual at a place where any user can read at any time. Moreover if necessary, ask to hand them to a new user.
- For installing qualified personnel, take precautions in respect to themselves by using suitable protective clothing, gloves, etc., and then perform the installation works.
- Please pay attention not to fall down the tools, etc. when installing the unit at the high position.
- If unusual noise can be heard during operation, consult the dealer.
- Symbols which appear frequently in the text have the following meaning:

Observe instructions with great care	Strictly prohibited	Provide proper earthing
--------------------------------------	---------------------	-------------------------

**WARNING**

- **Installation must be carried out by the qualified installer.**  
If you install the system by yourself, it may cause serious trouble such as water leaks, electric shocks, fire and personal injury, as a result of a system malfunction.
- **Install the system in full accordance with the instruction manual.**  
Incorrect installation may cause bursts, personal injury, water leaks, electric shocks and fire.
- **Be sure to use only for household and residence.**  
If this appliance is installed in inferior environment such as machine shop and etc., it can cause malfunction.
- **Use the original accessories and the specified components for installation.**  
If parts other than those prescribed by us are used, it may cause water leaks, electric shocks, fire and personal injury.
- **Install the unit in a location with good support.**  
Unsuitable installation locations can cause the unit to fall and cause material damage and personal injury.
- **Ventilate the working area well in the event of refrigerant leakage during installation.**  
If the refrigerant comes into contact with naked flames, poisonous gas is produced.
- **When installing in small rooms, take prevention measures not to exceed the density limit of refrigerant in the event of leakage.**  
Consult the expert about prevention measures. If the density of refrigerant exceeds the limit in the event of leakage, lack of oxygen can occur, which can cause serious accidents.
- **After completed installation, check that no refrigerant leaks from the system.**  
If refrigerant leaks into the room and comes into contact with an oven or other hot surface, poisonous gas is produced.
- **Use the prescribed pipes, flare nuts and tools for R410A.**  
Using existing parts (for R22 or R407C) can cause the unit failure and serious accidents due to burst of the refrigerant circuit.
- **Tighten the flare nut by torque wrench with specified method.**  
If the flare nut were tightened with excess torque, this may cause burst and refrigerant leakage after a long period.
- **The electrical installation must be carried out by the qualified electrician in accordance with "the norm for electrical work" and "national wiring regulation", and the system must be connected to the dedicated circuit.**  
Power supply with insufficient capacity and incorrect function done by improper work can cause electric shocks and fire.
- **Be sure to shut off the power before starting electrical work.**  
Failure to shut off the power can cause electric shocks, unit failure or incorrect function of equipment.
- **Be sure to use the cables conformed to safety standard and cable ampacity for power distribution work.**  
Unconformable cables can cause electric leak, anomalous heat production or fire.
- **This appliance must be connected to main power supply by means of a circuit breaker or switch (fuse:16A) with a contact separation of at least 3mm.**
- **When plugging this appliance, a plug conforming to the norm IEC60884-1 must be used.**
- **Use the prescribed cables for electrical connection, tighten the cables securely in terminal block and relieve the cables correctly to prevent overloading the terminal blocks.**  
Loose connections or cable mountings can cause anomalous heat production or fire.
- **Arrange the wiring in the control box so that it cannot be pushed up further into the box. Install the service panel correctly.**  
Incorrect installation may result in overheating and fire.
- **Be sure to switch off the power supply in the event of installation, inspection or servicing.**  
If the power supply is not shut off, there is a risk of electric shocks, unit failure or personal injury due to the unexpected start of fan.

- **Do not put the drainage pipe directly into drainage channels where poisonous gases such as sulphide gas can occur.**  
Poisonous gases will flow into the room through drainage pipe and seriously affect the user's health and safety.
- **Ensure that no air enters in the refrigerant circuit when the unit is installed and removed.**  
If air enters in the refrigerant circuit, the pressure in the refrigerant circuit becomes too high, which can cause burst and personal injury.
- **Do not processing, splice the power cord, or share a socket with other power plugs.**  
This may cause fire or electric shock due to defecting contact, defecting insulation and over-current etc.
- **Do not bundling, winding or processing for the power cord. Or, do not deforming the power plug due to tread it.**  
This may cause fire or heating.

**WARNING**

- **Do not vent R410A into the atmosphere : R410A is a fluorinated greenhouse gas, covered by the Kyoto Protocol with Global Warming Potential (GWP)=1975.**  
• **Do not run the unit with removed panels or protections.**  
Touching rotating equipments, hot surfaces or high voltage parts can cause personal injury due to entrapment, burn or electric shocks.
- **Do not perform any change of protective device itself or its setup condition.**  
The forced operation by short-circuiting protective device of pressure switch and temperature controller or the use of non specified component can cause fire or burst.
- **Carry out the electrical work for ground lead with care.**  
Do not connect the ground lead to the gas line, water line, lightning conductor or telephone line's ground lead. Incorrect grounding can cause unit faults such as electric shocks due to short-circuiting.

**CAUTION**

- **Use the circuit breaker with sufficient breaking capacity.**  
If the breaker does not have sufficient breaking capacity, it can cause the unit malfunction and fire.
- **Earth leakage breaker must be installed.**  
If the earth leakage breaker is not installed, it can cause electric shocks.
- **Install isolator or disconnect switch on the power supply wiring in accordance with the local codes and regulations.**
- **Be sure to install indoor unit properly according to the instruction manual in order to run off the drainage smoothly.**  
Improper installation of indoor unit can cause dropping water into the room and damaging personal property.
- **Install the drainage pipe to run off drainage securely according to the installation manual.**  
Incorrect installation of the drainage pipe can cause dropping water into the room and damaging personal property.
- **Be sure to install the drainage pipe with descending slope of 1/100 or more, and not to make traps and air-bleedings.**  
Check if the drainage runs off securely during commissioning and ensure the space for inspection and maintenance.
- **Secure a space for installation, inspection and maintenance specified in the manual.**  
Insufficient space can result in accident such as personal injury due to falling from the installation place.
- **For installation work, be careful not to get injured with the heat exchanger, piping flare portion or screws etc.**
- **Be sure to insulate the refrigerant pipes so as not to condense the ambient air moisture on them.**  
Insufficient insulation can cause condensation, which can lead to moisture damage on the ceiling, floor, furniture and any other valuables.
- **When perform the air conditioner operation (cooling or drying operation) in which ventilator is installed in the room. In this case, using the air conditioner in parallel with the ventilator, there is the possibility that drain water may backflow in accordance with the room lapse into the negative pressure status. Therefore, set up the opening port such as incorporate the air into the room that may appropriate to ventilation (For example; Open the door a little). In addition, just as above, so set up the opening port if the room lapse into negative pressure status due to register of the wind for the high rise apartment etc.**

- **Do not install the unit in the locations listed below.**
  - Locations where carbon fiber, metal powder or any powder is floating.
  - Locations where any substances that can affect the unit such as sulphide gas, chloride gas, acid and alkaline can occur.
  - Vehicles and ships.
  - Locations where cosmetic or special sprays are often used.
  - Locations with direct exposure of oil mist and steam such as kitchen and machine plant.
  - Locations where any machines which generate high frequency harmonics are used.
  - Locations with salty atmospheres such as coastlines.
  - Locations with heavy snow (If installed, be sure to provide base flame and snow hood mentioned in the manual).
  - Locations where the unit is exposed to chimney smoke.
  - Locations at high altitude (more than 1000m high).
  - Locations with ammoniac atmospheres.
  - Locations where heat radiation from other heat source can affect the unit.
  - Locations without good air circulation.
  - Locations with any obstacles which can prevent inlet and outlet air of the unit.
  - Locations where short circuit of air can occur (in case of multiple units installation).
  - Locations where strong air blows against the air outlet of outdoor unit. It can cause remarkable decrease in performance, corrosion and damage of components, malfunction and fire.
- **Do not install the indoor unit in the locations listed below (Be sure to install the indoor unit according to the installation manual for each model because each indoor unit has each limitation).**
  - Locations with any obstacles which can prevent inlet and outlet air of the unit.
  - Locations where vibration can be amplified due to insufficient strength of structure.
  - Locations where the infrared receiver is exposed to the direct sunlight or the strong light beam (in case of the infrared specification unit).
  - Locations where an equipment affected by high harmonics is placed (TV set or radio receiver is placed within 1m).
  - Locations where drainage cannot run off safely. It can affect performance or function and etc.
- **Do not install the unit near the location where leakage of combustible gases can occur.**  
If leaked gases accumulate around the unit, it can cause fire.
- **Do not install the unit where corrosive gas (such as sulfurous acid gas etc.) or combustible gas (such as thinner and petroleum gases) can accumulate or collect, or where volatile combustible substances are handled.**  
Corrosive gas can cause corrosion of heat exchanger, breakage of plastic parts and etc. And combustible gas can cause fire.
- **Do not use the indoor unit at the place where water splashes may occur such as in laundries.**  
Since the indoor unit is not waterproof, it can cause electric shocks and fire.
- **Do not install nor use the system close to the equipment that generates electromagnetic fields or high frequency harmonics.**  
Equipment such as inverters, standby generators, medical high frequency equipments and telecommunication equipments can affect the system, and cause malfunctions and breakdowns. The system can also affect medical equipment and telecommunication equipment, and obstruct its function or cause jamming.
- **Do not place any variables which will be damaged by getting wet under the indoor unit.**  
When the relative humidity is higher than 80% or drainage pipe is clogged, condensation or drainage water can drop and it can cause the damage of valuables.
- **Do not install the remote control at the direct sunlight.**  
It can cause malfunction or deformation of the remote control.
- **Do not use the unit for special purposes such as storing foods, cooling precision instruments and preservation of animals, plants or art.**  
It can cause the damage of the items.
- **Do not use any materials other than a fuse with the correct rating in the location where fuses are to be used.**  
Connecting the circuit with copper wire or other metal thread can cause unit failure and fire.
- **Do not touch any buttons with wet hands.**  
It can cause electric shocks.
- **Do not touch any refrigerant pipes with your hands when the system is in operation.**  
During operation the refrigerant pipes become extremely hot or extremely cold depending the operating condition, and it can cause burn injury or frost injury.

## BEFORE INSTALLATION

○ Before installation check that the power supply matches the air conditioner.

Standard accessories (Installation kit) Accessories for indoor unit		Q'ty
①	Installation board (Attached to the rear of the indoor unit)	1
②	Wireless remote control	1
③	Remote control holder	1
④	Tapping screws (for installation board ø4 X 25mm)	5
⑤	Wood screws (for remote control switch holder ø3.5 X 16mm)	2
⑥	Battery [R03 (AAA, Micro) 1.5V]	2
⑦	Air-cleaning filters	2
⑧	Filter holders (Attached to the front panel of indoor unit)	2
⑨	Insulation (#486 50 x 100 t3)	1

Option parts		Q'ty
a	Sealing plate	1
b	Sleeve	1
c	Inclination plate	1
d	Putty	1
e	Drain hose (extension hose)	1
f	Piping cover (for insulation of connection piping)	1

Necessary tools for the installation work	
1	Plus headed driver
2	Knife
3	Saw
4	Tape measure
5	Hammer
6	Spanner wrench
7	Torque wrench (14.0 - 61.0N·m (1.4 - 6.1kgf·m))
8	Hole core drill (65mm in diameter)
9	Wrench key (Hexagon) [4m/m]
10	Flaring tool set (Designed specifically for R410A)
11	Gas leak detector (Designed specifically for R410A)
12	Gauge for projection adjustment (Used when flare is made by using conventional flare tool)
13	Pipe bender

## SELECTION OF INSTALLATION LOCATION

(Install at location that meets the following conditions, after getting approval from the customer)

### Indoor unit

- Where there is no obstructions to the air flow and where the cooled and heated air can be evenly distributed.
- A solid place where the unit or the wall will not vibrate.
- A place where there will be enough space for servicing. (Where space mentioned below can be secured)
- Where wiring and the piping work will be easy to conduct.
- The place where receiving part is not exposed to the direct rays of the sun or the strong rays of the street lighting.
- A place where it can be easily drained.
- A place separated at least 1m away from the television or the radio. (To prevent interference to images and sounds.)
- Places where this unit is not affected by the high frequency equipment or electric equipment.
- Avoid installing this unit in place where there is much oil mist.
- Places where there is no electric equipment or household under the installing unit.

### Wireless remote control

- A place where the air conditioner can be received the signal surely during operating the wireless remote control.
- Places where there is no affected by the TV and radio etc.
- Do not place where exposed to direct sunlight or near heat devices such as a stove.

## INSTALLATION OF INDOOR UNIT

### Installation of Installation board

Look for the inside wall structures (Intermediats support or pillar and firmly install the unit after level surface has been checked.)

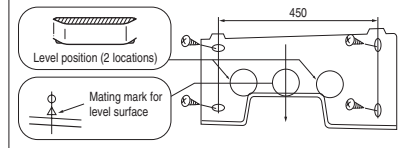

- Adjustment of the installation board in the horizontal direction is to be conducted with four screws in a temporary tightened state.
- Adjust so the board will be level by turning the board with the standard hole as the center.

### Drilling of holes and fixture of sleeve (Option parts)

When drilling the wall that contains a metal lath, wire lath or metal plate, be sure to use pipe hole sleeve sold separately.

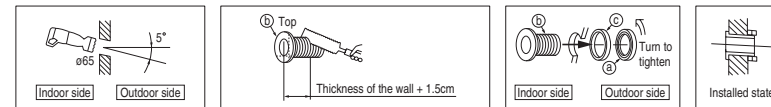

- Drill a hole with whole core drill.
- In case of rear piping draw out, cut off the lower and the right side portions of the sleeve collar.

### Installing the support of piping

#### In case of piping in the right rear direction

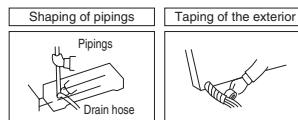

- Hold the bottom of the piping and fix direction before stretching it and shaping it.
- Tape only the portion that goes through the wall.
- Always tape the wiring with the piping.

Sufficient care must be taken not to damage the panel when connecting pipes.

#### Matters of special notice when piping from left or central/rear of the unit.

[Top view]

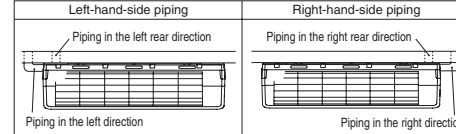

Piping is possible in the rear, left, left rear, left downward, right or downward direction.

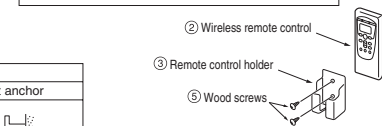
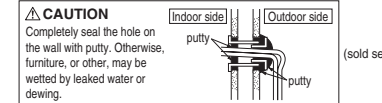
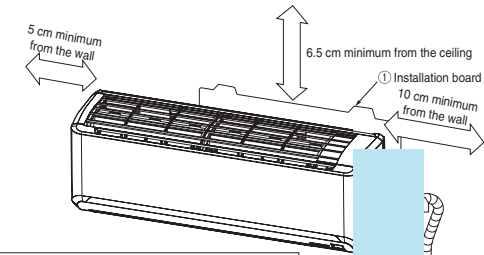
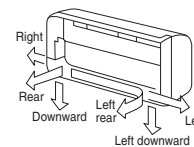

### Relation between setting plate and indoor unit

#### INSTALLATION SPACE (INDOOR UNIT) (FRONT VIEW)

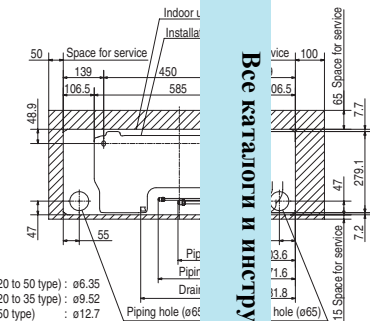

Piping for Liquid (20 to 50 type) : ø6.35  
Piping for Gas (20 to 35 type) : ø9.52  
(50 type) : ø12.7

#### [Drain hose changing procedures]

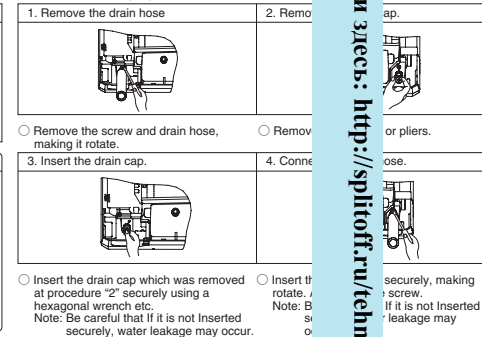

Без каталога и инструкции здесь: <http://splitoff.ru/ehh-doc.html>

### Fixing of indoor unit

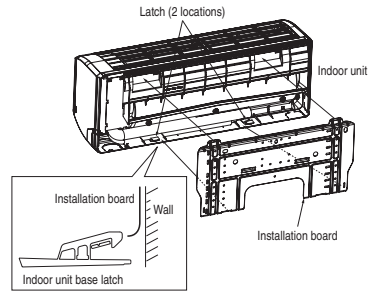

- Installation Steps**
- Pass the pipe through the hole in the wall, and hook the upper part of the indoor unit to the installation board.
  - Gently push the lower part to secure the unit.

### How to remove the indoor unit from the installation board

- Push up at the marked portion of the indoor unit base lower latch, and slightly pull it toward you. (both right and left hand sides) (The indoor unit base lower latch can be removed from the installation board)
- Push up the indoor unit upward. So the indoor unit will be removed from the installation board.

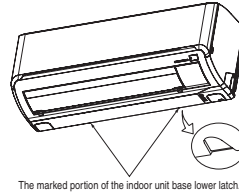

Since this air conditioner has been designed to collect dew drops on the rear surface to the drain pan, do not attach the power cord above the gutter.

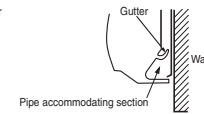

### Drainage

- Arrange the drain hose in a downward angle.
- Avoid the following drain piping.

**CAUTION** Go through all installation steps and check if the drainage is all right. Otherwise water leak may occur.

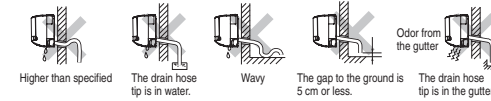

- Pour water to the drain pan located under the heat exchanger, and ensure that the water is discharged outdoor.
- When the extended drain hose is indoor, always use a shield pipe (to be arranged by the user) and ensure it is thermally insulated.

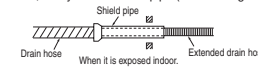

## CONNECTION OF REFRIGERANT PIPINGS

**Preparation** Keep the openings of the pipes covered with tapes etc. to prevent dust, sand, etc. from entering them.



- Remove the flared nuts. (on both liquid and gas sides)

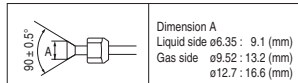

- Install the removed flared nuts to the pipes to be connected, then flared the pipes.

**CAUTION**  
Do not apply refrigerating machine oil to the flared surface.

### Flaring work

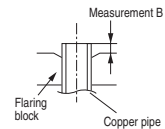

Copper pipe diameter	Measurement B (mm)		
	Clutch type flare tool for R410A	Conventional (R22) flare tool	
		Clutch type	Wing nut type
ø6.35	0.0 - 0.5	1.0 - 1.5	1.5 - 2.0
ø9.52	0.0 - 0.5	1.0 - 1.5	1.5 - 2.0
ø12.7	0.0 - 0.5	1.0 - 1.5	2.0 - 2.5

Use a flare tool designed for R410A or a conventional flare tool.  
Please note that measurement B (protrusion from the flaring block) will vary depending on the type of a flare tool in use.  
If a conventional flare tool is used, please use a copper pipe gauge or a similar instrument to check protrusion so that you can keep measurement B to a correct value.

### Connection

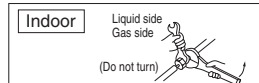

- Connect the pipes on both liquid and gas sides.
- Tighten the nuts to the following torque.  
Liquid side (ø6.35) : 14.0 - 18.0 N·m (1.4 - 1.8 kgf·m)  
Gas side (ø9.52) : 34.0 - 42.0 N·m (3.4 - 4.2 kgf·m)  
(ø12.7) : 49.0 - 61.0 N·m (4.9 - 6.1 kgf·m)

**CAUTION**  
Do not apply excess torque to the flared nuts. Otherwise, the flared nuts may check depending.

### Insulation of the connection portion

Cover the coupling with insulator and then cover it with tapes.

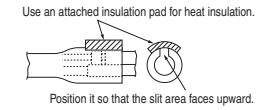
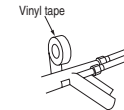

- Cover the indoor unit's flare-connected joints, after they are checked for a gas leak, with an indoor unit heat insulating material and then wrap them with a tape with an attached insulation pad placed over the heat insulating material's slit area.

### Finishing work and fixing

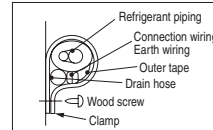

Cover the exterior portion with outer tape and shape the piping so it will match the contours of the route that the piping to take.  
Also fix the wiring and pipings to the wall with clamps.

### Open/close and detachment/attachment of the air inlet panel

- To open, pull the panel at both ends of lower part and release latches, then pull up the panel until you feel resistance.  
(The panel stops at approx. 60° open position)
- To close, hold the panel at both ends of lower part to lower downward and push it slightly until the latch works.
- To remove, pull up the panel to the position shown in right illustration and pull it toward you.
- To install, insert the panel arm into the slot on the front panel from the position shown in right illustration, hold the panel at both ends of lower part, lower it downward slowly, then push it slightly until the latch works.

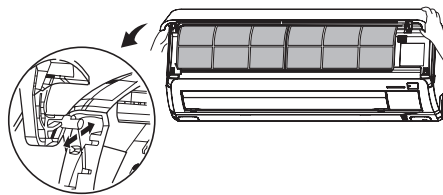

### How to remove and fit the front panel

- Removing
  - Remove the air inlet panel.
  - Remove the 2 set screws.
  - Remove the 3 latches in the upper section.
  - Move the lower part of the panel forward and push upwards to remove.
- Fitting
  - Do remove the air filter.
  - Cover the body with the front panel.
  - Fit the 3 latches in the upper section.
  - Tighten the 2 set screws.
  - Fit the air filter.
  - Fit the air inlet panel.

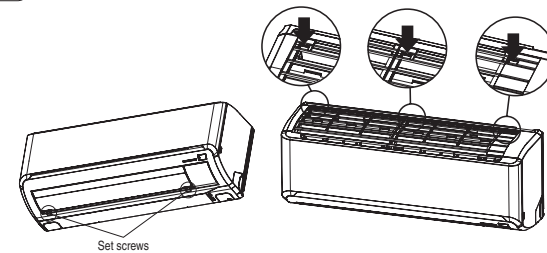



## ELECTRICAL WIRING WORK

### Preparation of indoor unit

#### Mounting of connecting wires

- ① Remove the lid.
- ② Remove the terminal cover.
- ③ Remove the wiring clamp.
- ④ Connect the connecting wire securely to the terminal block.
  - 1) Connect the connection wire securely to the terminal block. If the wire is not affixed completely, contact will be poor, and it is dangerous as the terminal block may heat up and catch fire.
  - 2) Take care not to confuse the terminal numbers for indoor and outdoor connections.
- ⑤ Fix the connecting wire by wiring clamp.
- ⑥ Attach the terminal cover.
- ⑦ Attach the lid.

#### CAUTION

In case of faulty wiring connection, the indoor unit stops, and then the run lamp turns on and the timer lamp blinks.

Use cables for interconnection wiring to avoid loosening of the wires.  
CENELEC code for cables Required field cables.

H05RN4G1.5 (example) or 245IEC57
H Harmonized cable type
05 300/500 volts
R Natural-and/or synth, rubber wire insulation
N Polychloroprene rubber conductors insulation
R Stranded core
4or5 Number of conductors
G One conductor of the cable is the earth conductor (yellow/green)
1.5 Section of copper wire (mm <sup>2</sup> )

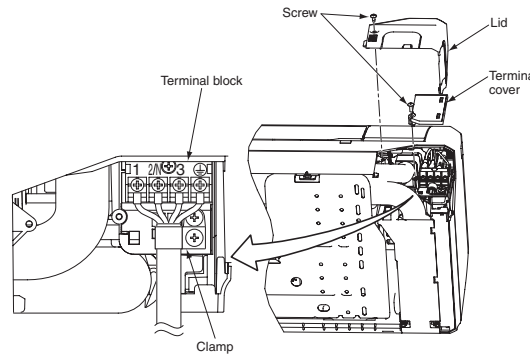

### Installing the air-cleaning filters

1. Open the air inlet panel and remove the air filters.
2. Install the filter holders, with the air-cleaning filters installed in the holders.
  - Each air-cleaning filter can be installed in the left or right.
3. Install the air filters and close the inlet panel.

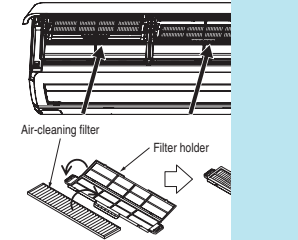

## INSTALLATION OF WIRELESS CONTROL

### Mounting method of battery

- Uncover the wireless remote control, and mount the batteries [R03 (AAA, Micro), ×2 pieces] in the body regularly. (Fit the poles with the indication marks, ⊕ & ⊖ without fail)

#### CAUTION

Do not use new and old batteries together.

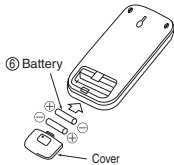

### Fixing to pillar or wall

- Conventionally, operate the wireless remote control by holding in your hand.
- Avoid installing it on a clay wall etc.

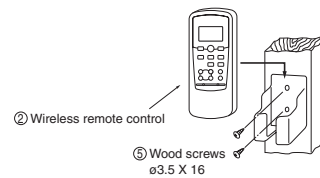

## INSTALLATION TEST CHECK POINTS

Check the following points again after completion of the installation, and before turning on the power. Conduct a test run again and ensure the unit operates properly. At the same time, explain to the customer how to use the unit and how to take care of the unit following the user's manual.

#### After installation

- The power supply voltage is correct as the rating.
- No gas leaks from the joints of the operation valve.
- Power cables and crossover wires are securely fixed to the terminal board.
- Operation valve is fully open.
- The pipe joints for indoor and outdoor pipes have been insulated.

#### Test run

- Air conditioning operation is normal.
- No abnormal noise.
- Water drains smoothly.
- Protective functions are not working.
- The remote control is normal.
- Operation of the unit has been explained to the customer. (Three-minutes restart preventive timer) When the air conditioner is restarted or when the power is turned on, the unit will not start operating for approximately 3 minutes. This is to protect the unit and it is not a malfunction.

## HOW TO RELOCATE OR DISPOSE OF THE UNIT

- In order to protect the environment, be sure to pump down (recovery of refrigerant).
- Pump down is the method of recovering refrigerant from the indoor unit to the outdoor unit when the pipes are removed from the unit.

- Forced cooling operation
  - Turn on a power supply again after a while after turn off a power supply. Then press continually the ON/OFF button 5 seconds or more.

#### <How to pump down>

- ① Connect charge hose to check joint of outdoor unit.
- ② Liquid side : Close the liquid valve with hexagon wrench key. Gas side : Fully open the gas valve. Carry out cooling operation. (If indoor temperature is low, operate forced cooling operation.)
- ③ After low pressure gauge become 0.01MPa, stop cooling operation and close the gas valve.

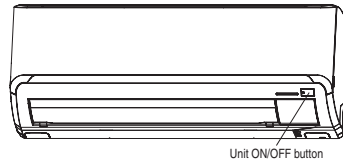

## CONCERNING TERMINAL CONNECTION FOR AN INTERFACE

- ① Remove the front panel and lid of control.
- ② Remove the control.
- ③ There is a terminal (respectively marked with CNS) for the indoor control board.

In connecting an interface, connect to the respective terminal securely with the connection harness supplied with an optional "Interface connection kit SC-BIKN-E" and fasten the connection harness onto the indoor control box with the clamp supplied with the kit.

For more details, please refer to the user's manual of your "Interface connection kit SC-BIKN-E".

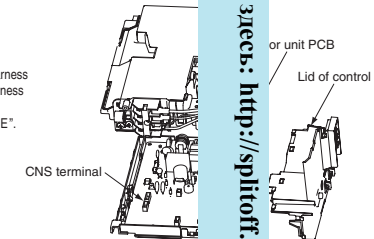

## (2) Floor standing type (SRF)

RFB012A002A 

- This instruction manual illustrates the method of installing an indoor unit.
- For electrical wiring work, please see instructions set out on the backside.
- For outdoor unit installation and refrigerant piping, please refer to page 127 and 138.



- A wired remote control unit is supplied separately as an optional part.
- When install the unit, be sure to check whether the selection of installation place, power supply specifications, usage limitation (piping length, height differences between indoor and outdoor units, power supply voltage and etc.) and installation spaces.





### SAFETY PRECAUTIONS

- We recommend you to read this "SAFETY PRECAUTIONS" carefully before the installation work in order to gain full advantage of the functions of the unit and to avoid malfunction due to mishandling.
- The precautions described below are divided into **WARNING** and **CAUTION**. The matters with possibilities leading to serious consequences such as death or serious personal injury due to erroneous handling are listed in the **WARNING** and the matters with possibilities leading to personal injury or damage of the unit due to erroneous handling including probability leading to serious consequences in some cases are listed in the **CAUTION**. These are very important precautions for safety. Be sure to observe all of them without fail.
- Be sure to confirm no anomaly on the equipment by commissioning after completed installation and explain the operating methods as well as the maintenance methods of this equipment to the user according to the owner's manual.

- Keep the installation manual together with owner's manual at a place where any user can read at any time. Moreover if necessary, ask to hand them to a new user.
- For installing qualified personnel, take precautions in respect to themselves by using suitable protective clothing, gloves, etc., and then perform the installation works.
- Please pay attention not to fall down the tools, etc. when installing the unit at the high position.
- If unusual noise can be heard during operation, consult the dealer.
- Symbols which appear frequently in the text have the following meaning:



 <b>WARNING</b>	
<p> • <b>Installation must be carried out by the qualified installer.</b> If you install the system by yourself, it may cause serious trouble such as water leaks, electric shocks, fire and personal injury, as a result of a system malfunction.</p> <p>• <b>Install the system in full accordance with the instruction manual.</b> Incorrect installation may cause bursts, personal injury, water leaks, electric shocks and fire.</p> <p>• <b>Be sure to use only for household and residence.</b> If this appliance is installed in inferior environment such as machine shop and etc., it can cause malfunction.</p> <p>• <b>Use the original accessories and the specified components for installation.</b> If parts other than those prescribed by us are used, it may cause water leaks, electric shocks, fire and personal injury.</p> <p>• <b>Install the unit in a location with good support.</b> Unsuitable installation locations can cause the unit to fall and cause material damage and personal injury.</p> <p>• <b>Ventilate the working area well in the event of refrigerant leakage during installation.</b> If the refrigerant comes into contact with naked flames, poisonous gas is produced.</p> <p>• <b>When installing in small rooms, take prevention measures not to exceed the density limit of refrigerant in the event of leakage.</b> Consult the expert about prevention measures. If the density of refrigerant exceeds the limit in the event of leakage, lack of oxygen can occur, which can cause serious accidents.</p> <p>• <b>After completed installation, check that no refrigerant leaks from the system.</b> If refrigerant leaks into the room and comes into contact with an oven or other hot surface, poisonous gas is produced.</p> <p>• <b>Use the prescribed pipes, flare nuts and tools for R410A.</b> Using existing parts (for R22 or R407C) can cause the unit failure and serious accidents due to burst of the refrigerant circuit.</p>	<p>• <b>Tighten the flare nut by torque wrench with specified method.</b> If the flare nut were tightened with excess torque, this may cause burst and refrigerant leakage after a long period.</p> <p>• <b>The electrical installation must be carried out by the qualified electrician in accordance with "the norm for electrical work" and "national wiring regulation", and the system must be connected to the dedicated circuit.</b> Power supply with insufficient capacity and incorrect function done by improper work can cause electric shocks, unit failure or incorrect function of equipment.</p> <p>• <b>Be sure to shut off the power before starting electrical work.</b> Failure to shut off the power can cause electric shocks, unit failure or incorrect function of equipment.</p> <p>• <b>Be sure to use the cables conformed to safety standard and cable ampacity for power distribution work.</b> Unconformable cables can cause electric leak, anomalous heat production or fire.</p> <p>• <b>This appliance must be connected to main power supply by means of a circuit breaker or switch (fuse:16A) with a contact separation of at least 3mm.</b></p> <p>• <b>When plugging this appliance, a plug conforming to the norm IEC60884-1 must be used.</b></p> <p>• <b>Use the prescribed cables for electrical connection, tighten the cables securely in terminal block and relieve the cables correctly to prevent overloading the terminal blocks.</b> Loose connections or cable mountings can cause anomalous heat production or fire.</p> <p>• <b>Arrange the wiring in the control box so that it cannot be pushed up further into the box. Install the service panel correctly.</b> Incorrect installation may result in overheating and fire.</p> <p>• <b>Be sure to switch off the power supply in the event of installation, inspection or servicing.</b> If the power supply is not shut off, there is a risk of electric shocks, unit failure or personal injury due to the unexpected start of fan.</p>
<p> • <b>Do not put the drainage pipe directly into drainage channels where poisonous gases such as sulphide gas can occur.</b> Poisonous gases will flow into the room through drainage pipe and seriously affect the user's health and safety.</p> <p>• <b>Ensure that no air enters in the refrigerant circuit when the unit is installed and removed.</b> If air enters in the refrigerant circuit, the pressure in the refrigerant circuit becomes too high, which can cause burst and personal injury.</p>	<p>• <b>Do not processing, splice the power cord, or share a socket with other power plugs.</b> This may cause fire or electric shock due to defecting contact, defecting insulation and over-current etc.</p> <p>• <b>Do not bundling, winding or processing for the power cord. Or, do not deforming the power plug due to treat it.</b> This may cause fire or heating.</p>

 <b>WARNING</b>	
<p> • <b>Do not vent R410A into the atmosphere : R410A is a fluorinated greenhouse gas, covered by the Kyoto Protocol with Global Warming Potential (GWP)=1975.</b></p> <p>• <b>Do not run the unit with removed panels or protections.</b> Touching rotating equipments, hot surfaces or high voltage parts can cause personal injury due to entrapment, burn or electric shocks.</p>	<p>• <b>Do not perform any change of protective device itself or its setup condition.</b> The forced operation by short-circuiting protective device of pressure switch and temperature controller or the use of non specified component can cause fire or burst.</p>
 <b>CAUTION</b>	
<p> • <b>Use the circuit breaker with sufficient breaking capacity.</b> If the breaker does not have sufficient breaking capacity, it can cause the unit malfunction and fire.</p> <p>• <b>Earth leakage breaker must be installed.</b> If the earth leakage breaker is not installed, it can cause electric shocks.</p> <p>• <b>Install isolator or disconnect switch on the power supply wiring in accordance with the local codes and regulations.</b></p> <p>• <b>Be sure to install indoor unit properly according to the instruction manual in order to run off the drainage smoothly.</b> Improper installation of indoor unit can cause dropping water into the room and damaging personal property.</p> <p>• <b>Install the drainage pipe to run off drainage securely according to the installation manual.</b> Incorrect installation of the drainage pipe can cause dropping water into the room and damaging personal property.</p> <p>• <b>Be sure to install the drainage pipe with descending slope of 1/100 or more, and not to make traps and air-bleedings.</b> Check if the drainage runs off securely during commissioning and ensure the space for inspection and maintenance.</p>	<p>• <b>Secure a space for installation, inspection and maintenance specified in the manual.</b> Insufficient space can result in accident such as personal injury due to falling from the installation place.</p> <p>• <b>For installation work, be careful not to get injured with the heat exchanger, piping flare portion or screws etc.</b></p> <p>• <b>Be sure to insulate the refrigerant pipes so as not to condense the ambient air moisture on them.</b> Insufficient insulation can cause condensation, which can lead to moisture damage on the ceiling, floor, furniture and any other valuables.</p> <p>• <b>When perform the air conditioner operation (cooling or drying operation) in which ventilator is installed in the room. In this case, using the air conditioner in parallel with the ventilator, there is the possibility that drain water may backflow in accordance with the room lapse into the negative pressure status. Therefore, set up the opening port such as incorporate the air into the room that may appropriate to ventilation (For example: Open the door a little). In addition, just as above, so set up the opening port if the room lapse into negative pressure status due to the register of the wind for the high rise apartment etc.</b></p>
<p> • <b>Do not install the unit in the locations listed below.</b></p> <ul style="list-style-type: none"> <li>• Locations where carbon fiber, metal powder or any powder is floating.</li> <li>• Locations where any substances that can affect the unit such as sulphide gas, chloride gas, acid and alkaline can occur.</li> <li>• Vehicles and ships.</li> <li>• Locations where cosmetic or special sprays are often used.</li> <li>• Locations with direct exposure of oil mist and steam such as kitchen and machine plant.</li> <li>• Locations where any machines which generate high frequency harmonics are used.</li> <li>• Locations with salty atmospheres such as coastlines.</li> <li>• Locations with heavy snow (If installed, be sure to provide base flame and snow hood mentioned in the manual).</li> <li>• Locations where the unit is exposed to chimney smoke.</li> <li>• Locations at high altitude (more than 1000m high).</li> <li>• Locations with ammoniac atmospheres.</li> <li>• Locations where heat radiation from other heat source can affect the unit.</li> <li>• Locations without good air circulation.</li> <li>• Locations with any obstacles which can prevent inlet and outlet air of the unit.</li> <li>• Locations where short circuit of air can occur (in case of multiple units installation).</li> <li>• Locations where strong air blows against the air outlet of outdoor unit. It can cause remarkable decrease in performance, corrosion and damage of components, malfunction and fire.</li> </ul> <p>• <b>Do not install the indoor unit in the locations listed below (Be sure to install the indoor unit according to the installation manual for each model because each indoor unit has each limitation).</b></p> <ul style="list-style-type: none"> <li>• Locations with any obstacles which can prevent inlet and outlet air of the unit.</li> <li>• Locations where vibration can be amplified due to insufficient strength of structure.</li> <li>• Locations where the infrared receiver is exposed to the direct sunlight or the strong light beam (in case of the infrared specification unit).</li> <li>• Locations where an equipment affected by high harmonics is placed (TV set or radio receiver is placed within 1m).</li> <li>• Locations where drainage cannot run off safely.</li> </ul> <p>It can affect performance or function and etc.</p> <p>• <b>Do not install the unit near the location where leakage of combustible gases can occur.</b> If leaked gases accumulate around the unit, it can cause fire.</p>	<p>• <b>Do not install the unit where corrosive gas (such as sulfurous acid gas etc.) or combustible gas (such as thinner and petroleum gases) can accumulate or collect, or where volatile combustible substances are handled.</b> Corrosive gas can cause corrosion of heat exchanger, breakage of plastic parts and etc. And combustible gas can cause fire.</p> <p>• <b>Do not use the indoor unit at the place where water splashes may occur such as in laundries.</b> Since the indoor unit is not waterproof, it can cause electric shocks and fire.</p> <p>• <b>Do not install nor use the system close to the equipment that generates electromagnetic fields or high frequency harmonics.</b> Equipment such as inverters, standby generators, medical high frequency equipments and telecommunication equipments can affect the system, and cause malfunctions and breakdowns. The system can also affect medical equipment and telecommunication equipment, and obstruct its function or cause jamming.</p> <p>• <b>Do not place any variables which will be damaged by getting wet under the indoor unit.</b> When the relative humidity is higher than 80% or drainage pipe is clogged, condensation or drainage water can drop and it can cause the damage of valuables.</p> <p>• <b>Do not install the remote control at the direct sunlight.</b> It can cause malfunction or deformation of the remote control.</p> <p>• <b>Do not use the unit for special purposes such as storing foods, cooling precision instruments and preservation of animals, plants or art.</b> It can cause the damage of the items.</p> <p>• <b>Do not use any materials other than a fuse with the correct rating in the location where fuses are to be used.</b> Connecting the circuit with copper wire or other metal thread can cause unit failure and fire.</p> <p>• <b>Do not touch any buttons with wet hands.</b> It can cause electric shocks.</p> <p>• <b>Do not touch any refrigerant pipes with your hands when the system is in operation.</b> During operation the refrigerant pipes become extremely hot or extremely cold depending the operating condition, and it can cause burn injury or frost injury.</p>

## BEFORE INSTALLATION

○ Before installation check that the power supply matches the air conditioner.

Standard accessories (Installation kit) Accessories for indoor unit		
①	Installation board (Attached to the rear of the indoor unit)	1
②	Wireless remote control	1
③	Remote control holder	1
④	Tapping screws (for installation board 4dia. by 25mm)	9
⑤	Wood screws (for remote control switch holder 3.5(mm), by 16mm)	2
⑥	Battery [R03(AAA, Micro) 1.5V]	2
⑦	Air-cleaning filters	2
⑧	Filter holders (Attached to the front panel of indoor unit)	2
⑨	Pipe cover (200mm)	1
⑩	Band	2

Option parts		
Ⓐ	Sealing plate	1
Ⓑ	Sleeve	1
Ⓒ	Inclination plate	1
Ⓓ	Putty	1
Ⓔ	Drain hose (extension hose)	1
①	Piping cover (for insulation of connection piping)	1

Necessary tools for the installation work		
1	Plus headed driver	
2	Knife	
3	Saw	
4	Tape measure	
5	Hammer	
6	Spanner wrench	
7	Torque wrench (14.0 ~ 61.0N·m (1.4 ~ 6.1kgf·m))	
8	Hole core drill (65mm in diameter)	
9	Wrench key (Hexagon) [4m/m]	
10	Flaring tool set (Designed specifically for R410A)	
11	Gas leak detector (Designed specifically for R410A)	
12	Gauge for projection adjustment (Used when flare is made by using conventional flare tool)	
13	Pipe bender	

## SELECTION OF INSTALLATION LOCATION

(Install at location that meets the following conditions, after getting approval from the customer)

### Indoor unit

- Where there is no obstructions to the air flow and where the cooled and heated air can be evenly distributed.
- A solid place where the unit or the wall will not vibrate.
- A place where there will be enough space for servicing. (Where space mentioned below can be secured)
- Where wiring and the piping work will be easy to conduct.
- The place where receiving part is not exposed to the direct rays of the sun or the strong rays of the street lighting.
- A place where it can be easily drained.
- A place separated at least 1m away from the television or the radio. (To prevent interference to images and sounds.)
- Places where this unit is not affected by the high frequency equipment or electric equipment.
- Avoid installing this unit in place where there is much oil mist.
- Places where there is no electric equipment or household under the installing unit.
- Install the indoor unit on flat wall.

### Wireless remote control

- A place where the air conditioner can be received the signal surely during operating the wireless remote control.
- Places where there is no affected by the TV and radio etc.
- Do not place where exposed to direct sunlight or near heat devices such as a stove.

## INSTALLATION OF INDOOR UNIT

### Open and detachment of the air inlet panel

- To open, pull the panel at both ends of upper part and release latches, and undo the strings. Then remove the panel.

**CAUTION**  
When removing the air-inlet panel, be careful not to drop it on your feet.

### How to remove the front panel

- Remove the air inlet panel.
- Remove the 5 set screws.
- Remove the 3 latches in the upper section. If the latches are difficult to remove, push the latch portion out using a screw driver, for example.
- Move the lower part of the panel forward and remove the 6 latches in the under section.

### Drilling of holes and fixture of sleeve (Option parts)

When drilling the wall that contains a metal lath, wire lath or metal plate, be sure to use pipe hole sleeve sold separately.

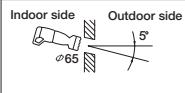

○ Drill a hole with whole core drill.

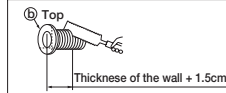

○ In case of rear piping draw out, cut off the lower and the right side portions of the sleeve collar.

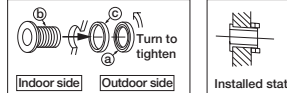

Installed state

### Indoor unit piping direction

Piping is possible in the rear, left, left rear, left downward, right or downward direction.

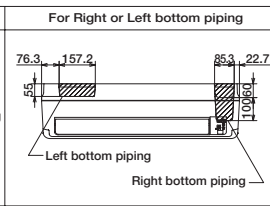
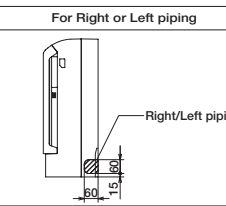
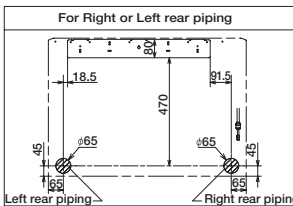
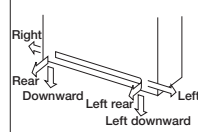

### Drainage

- Arrange the drain hose in a downward angle
- Avoid the following drain piping.

**CAUTION** Go through all installation steps and check if the drainage is all right. Otherwise water leak may occur.

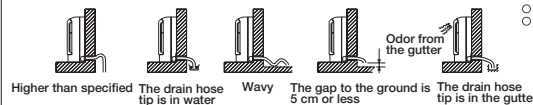

- Pour water to the drain pan located under the heat exchanger, and ensure that the water is discharged thermally insulated
- When the extended drain hose is indoor, always use a shield pipe (to be arranged by the user) and extend it to the outdoors.

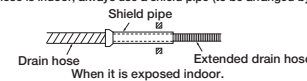

When it is exposed indoor.

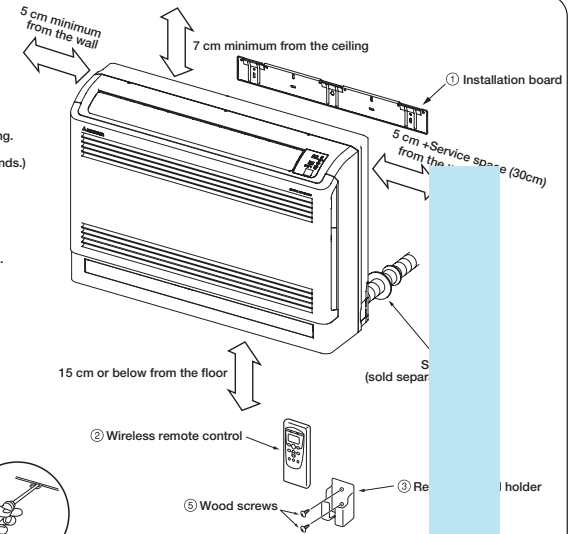

**CAUTION**  
Completely seal the hole on the wall with putty. Otherwise, furniture, or other, may be wetted by leaked water or dewing.

### Installing the support of piping

#### In case of piping in the right rear corner

**Taping of the exterior**  
○ Tape only the part that goes through the wall.  
○ Always tape it with the piping.  
Sufficient care must be taken not to damage the panel when connecting pipes.

Ве каталог и инструкции здесь: <http://splitoff.ru/ehh-doc.html>

### Fixing of indoor unit

**CAUTION** During the installation, do not lean on the control box or the display, as they may be damaged.  
 Install the indoor unit on flat wall. If improperly installed, it may cause abnormal noise and vibration. (Distortion on the wall shall be no larger than 3 mm.)

#### Floor installation

Secure using upper 2 screws for floor installations. If possible, also attach two lower screws.

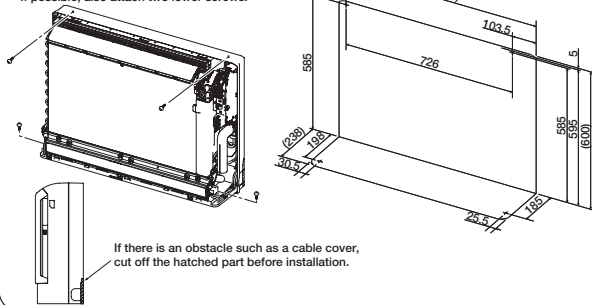

If there is an obstacle such as a cable cover, cut off the hatched part before installation.

#### Wall installation

At first secure the installation board using 5 screws and the indoor unit using 2 screws.

#### Installation of Installation board

Look for the inside wall structures (Intersediats support or pillar and finally install the unit after level surface has been checked.)



Fixing on concrete wall  
Use of nut anchor

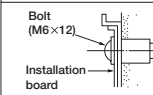

- Adjustment of the installation board in the horizontal direction is to be conducted with five screws in a temporary tightened state.
- Adjust so the board will be level by turning the board with the standard hole as the center.

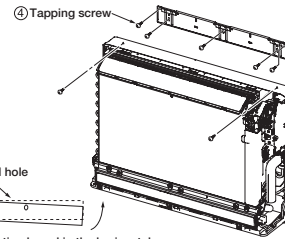

When practicing the half-console, make sure to fix the unit securely. Otherwise, it could fall.

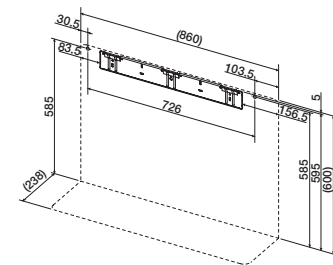

## CONNECTION OF REFRIGERANT PIPINGS

#### Preparation

Keep the openings of the pipes covered with tapes etc. to prevent dust, sand, etc. from entering them.

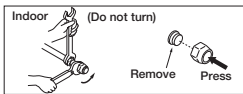

Remove the flared nuts. (on both liquid and gas sides)

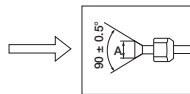

Install the removed flared nuts to the pipes to be connected, then flared the pipes.

Dimension A
Liquid side $\phi 6.35:9.1(\text{mm})$
Gas side $\phi 9.52:13.2(\text{mm})$
$\phi 12.7:16.6(\text{mm})$

#### CAUTION

Do not apply refrigerating machine oil to the flared surface.

#### Flaring work

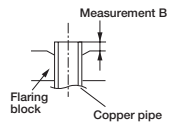

Copper pipe diameter	Measurement B (mm)		
	Clutch type flare tool for R410A	Conventional (R22) flare tool	
		Clutch type	Wing nut type
$\phi 6.35$	0.0 - 0.5	1.0 - 1.5	1.5 - 2.0
$\phi 9.52$	0.0 - 0.5	1.0 - 1.5	1.5 - 2.0
$\phi 12.7$	0.0 - 0.5	1.0 - 1.5	2.0 - 2.5

Use a flare tool designed for R410A or a conventional flare tool. Please note that measurement B (protrusion from the flaring block) will vary depending on the type of a flare tool in use. If a conventional flare tool is used, please use a copper pipe gauge or a similar instrument to check protrusion so that you can keep measurement B to a correct value.

**CAUTION** Be careful not to stress the connecting refrigerant pipes. (Do not pull with a force of larger than 5 kgf.)

#### Connection

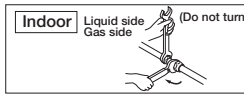

- Connect the pipes on both liquid and gas sides.
- Tighten the nuts to the following torque.
  - Liquid side ( $\phi 6.35$ ) : 14.0 - 19.0 N·m (1.4 - 1.8 kgf·m)
  - Liquid side ( $\phi 9.52$ ) : 34.0 - 42.0 N·m (3.4 - 4.2 kgf·m)
  - Gas side ( $\phi 12.7$ ) : 49.0 - 61.0 N·m (4.9 - 6.1 kgf·m)

#### CAUTION

Do not apply excess torque to the flared nuts. Otherwise, the flared nuts may check depending.

#### Insulation of the connection portion

Pass the refrigerant pipe through the piping hole to indoor side. Arrange the pipes according to the direction of piping.

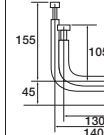

Cover the coupling with insulator and then cover it with tapes. Use an attached pipe cover for heat insulation.

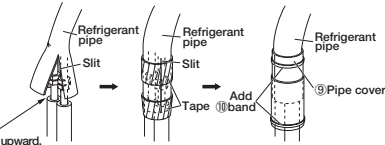

#### CAUTION

If heat insulation is insufficient, water leakage may occur. In addition, the room temperature sensor may give a false alert due to heat radiation from the pipes.

- Cover the indoor unit's flare-connected joints, after they are checked for a gas leak, with an indoor unit heat insulating material and then wrap them with a tape with an attached pipe cover placed over the heat insulating material's slit area.

## ELECTRICAL WIRING WORK

#### Preparation of indoor unit

#### Mounting of connecting wires

- Remove the fixing screw of clamp.
- Connect the connecting wire securely to the terminal block.
  - Connect the connection wire securely to the terminal block. If the wire is not affixed completely, contact will be poor, and it is dangerous as the terminal block may heat up and catch fire.
  - Take care not to confuse the terminal numbers for indoor and outdoor connections.
- Fix the connecting wire by wiring clamp.
- Pass the connecting wire through the wiring holder.

#### CAUTION

In case of faulty wiring connection, the indoor unit stops, and then the run lamp turns on and the timer lamp blinks.

Use cables for interconnection wiring to avoid loosening of the wires.  
 GENELEC code for cables Required field cables.

H05RN4G1.5 (example) or 245IEC57
H Harmonized cable type
05 300/500 volts
R Natural-and/or synth, rubber wire insulation
N Polychloroprene rubber conductors insulation
R Stranded core
4or5 Number of conductors
G One conductor of the cable is the earth conductor (yellow/green)
1.5 Section of copper wire (mm <sup>2</sup> )

#### CAUTION

- During installation, do not lean on the control box or the display, as they may be damaged.
- Pass the connecting wire securely through the wiring holder. If it passes on the sensor, it may not detect suction temperature and/or humidity.

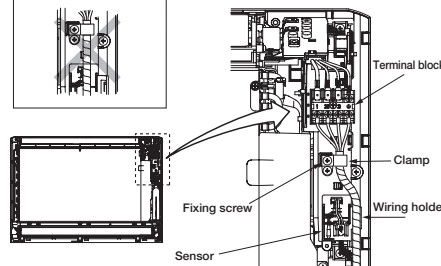

#### How to fit the front panel

- Fitting
  - Do remove the air filter.
  - Cover the body with the front panel.
  - Fit the 6 latches in the lower section.
  - Then 3 latches in the upper section.
  - Tighten the 5 set screws.
  - Fit the air filter.
  - Fit the air inlet panel.

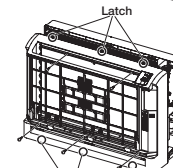

#### Close and attachment of the air inler panel

- To close, attach the panel after pulling the strings, hold the panel at both ends of upper part to lower downward and push it slightly until the latch works.

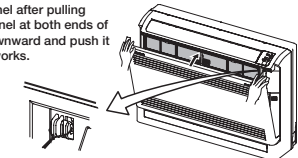

### Concealed installation

- Install the indoor unit according to the following instructions.
- Secure the upper, right, and left spaces according to the right figure.
  - Do not let the horizontal bar obstruct wind from blowing out upward/downward or reception from the remote controller.
  - The lattice size should be 70 % or greater of the open rate.
  - Cut the jumper cable (JP173) on the indoor circuit board to control the blow-out angle.

**CAUTION**  
Incorrect installation may cause problems such as non-cooling, non-warming, and condensation water leaking into the room.

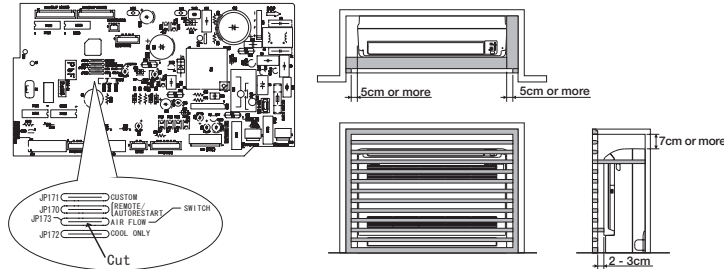

### Installing the air-cleaning filters

- Open the air inlet panel and remove the air filters.
- Install the filter holders, with the air-cleaning filters installed in the air conditioner.
  - Each air-cleaning filter can be installed in the upper or lower.
- Install the air filters and close the inlet panel.

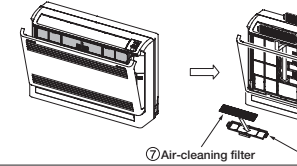

**CAUTION**  
When installing an air-cleaning filter in the indoor unit, be careful not to touch your hand with the heat exchanger.

## INSTALLATION OF REMOTE CONTROL

### Mounting method of battery

- Uncover the wireless remote control, and mount the batteries [R03(AAA, Micro), ×2 pieces] in the body regularly. (Fit the poles with the indication marks, ⊕ & ⊖ without fall)

**CAUTION**  
Do not use new and old batteries together.

### Fixing to pillar or wall

- Conventionally, operate the remote control switch by holding in your hand.
- Avoid installing it on a clay wall etc.

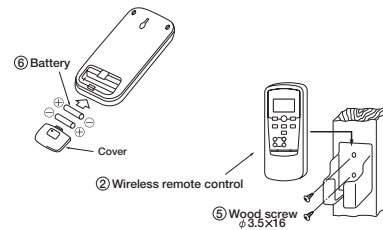

## HOW TO RELOCATE OR DISPOSE OF THE UNIT

- In order to protect the environment, be sure to pump down (recovery of refrigerant).
- Pump down is the method of recovering refrigerant from the indoor unit to the outdoor unit when the pipes are removed from the unit.
- Forced cooling operation  
Turn on a power supply again after a while after turning off the power supply. Then press continually the ON/OFF button 5 seconds.

- <How to pump down>
- Connect charge hose to service port of outdoor unit.
  - Liquid side : Close the liquid valve with hexagon wrench key.  
Gas side : Fully open the gas valve  
Carry out cooling operation . (If indoor temperature is low, operate forced cooling operation.)
  - After low pressure gauge become 0.01MPa, stop cooling operation and close the gas valve.

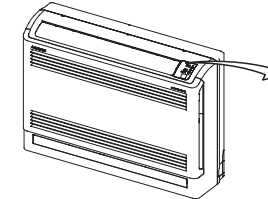

## INSTALLATION TEST CHECK POINTS

Check the following points again after completion of the installation, and before turning on the power. Conduct a test run again and ensure that the unit operates properly. At the same time, explain to the customer how to use the unit and how to take care of the unit following the user's manual.

### After installation

- The power supply voltage is correct as the rating.
- No gas leaks from the joints of the operational valve.
- Power cables and crossover wires are securely fixed to the terminal board.
- Operational valve is fully open.
- The pipe joints for indoor and outdoor pipes have been insulated.

### Test run

- Air conditioning operation is normal.
- No abnormal noise.
- Water drains smoothly.
- Protective functions are not working.
- The remote control is normal.
- Operation of the unit has been explained to the customer. (Three-minutes restart preventive timer)  
When the air conditioner is restarted or when changing the operation, the unit will not start operating for approximately 3 minutes.  
This is to protect the unit and it is not a malfunction.

## CONCERNING TERMINAL CONNECTION FOR AN INTERFACE

- Remove the front panel and lid of control.
- There is a terminal (respectively marked with CNS) for the indoor unit in connecting an interface. connect to the respective terminal securely In connecting an interface, connect to the respective terminal securely harness supplied with an optional "Interface connection kit SC-BIKN-connection harness onto the indoor control box with the clamp supplied. For more details, please refer to the user's manual of your "Interface connection kit SC-BIKN-E".



### (3) Ceiling concealed type (SRR)

RJD012A201

- This instruction manual illustrates the method of installing an indoor unit.
- For electrical wiring work, please see instructions set out on the backside.
- For outdoor unit installation and refrigerant piping, please refer to page 127 and 138

- A wired remote control unit is supplied separately as an optional part.
- When install the unit, be sure to check whether the selection of installation place, power supply specifications, usage limitation (piping length, height differences between indoor and outdoor units, power supply voltage and etc.) and installation spaces.

## SAFETY PRECAUTIONS

- We recommend you to read this "SAFETY PRECAUTIONS" carefully before the installation work in order to gain full advantage of the functions of the unit and to avoid malfunction due to mishandling.
- The precautions described below are divided into **WARNING** and **CAUTION**. The matters with possibilities leading to serious consequences such as death or serious personal injury due to erroneous handling are listed in the **WARNING** and the matters with possibilities leading to personal injury or damage of the unit due to erroneous handling including probability leading to serious consequences in some cases are listed in **CAUTION**. These are very important precautions for safety. Be sure to observe all of them without fail.
- Be sure to confirm no anomaly on the equipment by commissioning after completed installation and explain the operating methods as well as the maintenance methods of this equipment to the user according to the owner's manual.

- Keep the installation manual together with owner's manual at a place where any user can read at any time. Moreover if necessary, ask to hand them to a new user.
- For installing qualified personnel, take precautions in respect to themselves by using suitable protective clothing, gloves, etc., and then perform the installation works.
- Please pay attention not to fall down the tools, etc. when installing the unit at the high position.
- If unusual noise can be heard during operation, consult the dealer.
- Symbols which appear frequently in the text have the following meaning:



### WARNING

- **Installation must be carried out by the qualified installer.**  
If you install the system by yourself, it may cause serious trouble such as water leaks, electric shocks, fire and personal injury, as a result of a system malfunction.
- **Install the system in full accordance with the instruction manual.**  
Incorrect installation may cause bursts, personal injury, water leaks, electric shocks and fire.
- **Be sure to use only for household and residence.**  
If this appliance is installed in inferior environment such as machine shop and etc., it can cause malfunction.
- **Use the original accessories and the specified components for installation.**  
If parts other than those prescribed by us are used, it may cause water leaks, electric shocks, fire and personal injury.
- **Install the unit in a location with good support.**  
Unsuitable installation locations can cause the unit to fall and cause material damage and personal injury.
- **Ventilate the working area well in the event of refrigerant leakage during installation.**  
If the refrigerant comes into contact with naked flames, poisonous gas is produced.
- **When installing in small rooms, take prevention measures not to exceed the density limit of refrigerant in the event of leakage.**  
Consult the expert about prevention measures. If the density of refrigerant exceeds the limit in the event of leakage, lack of oxygen can occur, which can cause serious accidents.
- **After completed installation, check that no refrigerant leaks from the system.**  
If refrigerant leaks into the room and comes into contact with an oven or other hot surface, poisonous gas is produced.
- **Use the prescribed pipes, flare nuts and tools for R410A.**  
Using existing parts (for R22 or R407C) can cause the unit failure and serious accidents due to burst of the refrigerant circuit.

- **Do not put the drainage pipe directly into drainage channels where poisonous gases such as sulphide gas can occur.**  
Poisonous gases will flow into the room through drainage pipe and seriously affect the user's health and safety.
- **Ensure that no air enters in the refrigerant circuit when the unit is installed and removed.**  
If air enters in the refrigerant circuit, the pressure in the refrigerant circuit becomes too high, which can cause burst and personal injury.
- **Tighten the flare nut by torque wrench with specified method.**  
If the flare nut were tightened with excess torque, this may cause burst and refrigerant leakage after a long period.
- **The electrical installation must be carried out by the qualified electrician in accordance with "the norm for electrical work" and "national wiring regulation", and the system must be connected to the dedicated circuit.**  
Power supply with insufficient capacity and incorrect function done by improper work can cause electric shocks and fire.
- **Be sure to shut off the power before starting electrical work.**  
Failure to shut off the power can cause electric shocks, unit failure or incorrect function of equipment.
- **Be sure to use the cables conformed to safety standard and cable ampacity for power distribution work.**  
Unconformable cables can cause electric leak, anomalous heat production or fire.
- **This appliance must be connected to main power supply by means of a circuit breaker or switch (fuse:16A) with a contact separation of at least 3mm.**
- **When plugging this appliance, a plug conforming to the norm IEC60884-1 must be used.**
- **Use the prescribed cables for electrical connection, tighten the cables securely in terminal block and relieve the cables correctly to prevent overloading the terminal blocks.**  
Loose connections or cable mountings can cause anomalous heat production or fire.
- **Arrange the wiring in the control box so that it cannot be pushed up further into the box. Install the service panel correctly.**  
Incorrect installation may result in overheating and fire.
- **Be sure to switch off the power supply in the event of installation, inspection or servicing.**  
If the power supply is not shut off, there is a risk of electric shocks, unit failure or personal injury due to the unexpected start of fan.
- **Do not processing, splice the power cord, or share a socket with other power plugs.**  
This may cause fire or electric shock due to defecting contact, defecting insulation and over-current etc.
- **Do not bundling, winding or processing for the power cord. Or, do not deforming the power plug due to tread it.**  
This may cause fire or heating.

### WARNING

- **Do not vent R410A into the atmosphere : R410A is a fluorinated greenhouse gas, covered by the Kyoto Protocol with Global Warming Potential (GWP)=1975.**
- **Do not run the unit with removed panels or protections.**  
Touching rotating equipments, hot surfaces or high voltage parts can cause personal injury due to entrapment, burn or electric shocks.
- **Do not perform any change of protective device itself or its setup condition.**  
The forced operation by short-circuiting protective device of pressure switch and temperature controller or the use of non specified component can cause fire or burst.
- **Carry out the electrical work for ground lead with care.**  
Do not connect the ground lead to the gas line, water line, lightning conductor or telephone line's ground lead. Incorrect grounding can cause unit faults such as electric shocks due to short-circuiting.

### CAUTION

- **Use the circuit breaker with sufficient breaking capacity.**  
If the breaker does not have sufficient breaking capacity, it can cause the unit malfunction and fire.
- **Earth leakage breaker must be installed.**  
If the earth leakage breaker is not installed, it can cause electric shocks.
- **Install Isolator or disconnect switch on the power supply wiring in accordance with the local codes and regulations.**
- **Be sure to install indoor unit properly according to the instruction manual in order to run off the drainage smoothly.**  
Improper installation of indoor unit can cause dropping water into the room and damaging personal property.
- **Install the drainage pipe to run off drainage securely according to the installation manual.**  
Incorrect installation of the drainage pipe can cause dropping water into the room and damaging personal property.
- **Be sure to install the drainage pipe with descending slope of 1/100 or more, and not to make traps and air-bleedings.**  
Check if the drainage runs off securely during commissioning and ensure the space for inspection and maintenance.
- **Secure a space for installation, inspection and maintenance specified in the manual.**  
Insufficient space can result in accident such as personal injury due to falling from the installation place.
- **For installation work, be careful not to get injured with the heat exchanger, piping flare portion or screws etc.**
- **Be sure to insulate the refrigerant pipes so as not to condense the ambient air moisture on them.**  
Insufficient insulation can cause condensation, which can lead to moisture damage on the ceiling, floor, furniture and any other valuables.
- **When perform the air conditioner operation (cooling or drying operation) in which ventilator is installed in the room. In this case, using the air conditioner in parallel with the ventilator, there is the possibility that drain water may backflow in accordance with the room lapse into the negative pressure status. Therefore, set up the opening port such as incorporate the air into the room that may appropriate to ventilation (For example; Open the door a little). In addition, just as above, so set up the opening port if the room lapse into negative pressure status due to register of the wind for the high rise apartment etc.**

- **Do not install the unit in the locations listed below.**
  - Locations where carbon fiber, metal powder or any powder is floating.
  - Locations where any substances that can affect the unit such as sulphide gas, chloride gas, acid and alkaline can occur.
  - Vehicles and ships.
  - Locations where cosmetic or special sprays are often used.
  - Locations with direct exposure of oil mist and steam such as kitchen and machine plant.
  - Locations where any machines which generate high frequency harmonics are used.
  - Locations with salty atmospheres such as coastlines.
  - Locations with heavy snow (If installed, be sure to provide base flame and snow hood mentioned in the manual).
  - Locations where the unit is exposed to chimney smoke.
  - Locations at high altitude (more than 1000m high).
  - Locations with ammonic atmospheres.
  - Locations where heat radiation from other heat source can affect the unit.
  - Locations without good air circulation.
  - Locations with any obstacles which can prevent inlet and outlet air of the unit.
  - Locations where short circuit of air can occur (in case of multiple units installation).
  - Locations where strong air blows against the air outlet of outdoor unit. It can cause remarkable decrease in performance, corrosion and damage of components, malfunction and fire.
- **Do not install the indoor unit in the locations listed below (Be sure to install the indoor unit according to the installation manual for each model because each indoor unit has each limitation).**
  - Locations with any obstacles which can prevent inlet and outlet air of the unit.
  - Locations where vibration can be amplified due to insufficient strength of structure.
  - Locations where the Infrared receiver is exposed to the direct sunlight or the strong light beam (in case of the Infrared specification unit).
  - Locations where an equipment affected by high harmonics is placed (TV set or radio receiver is placed within 1m).
  - Locations where drainage cannot run off safely. It can affect performance or function and etc.
- **Do not install the unit near the location where leakage of combustible gases can occur.**  
If leaked gases accumulate around the unit, it can cause fire.
- **Do not install the unit where corrosive gas (such as sulfuric acid gas etc.) or combustible gas (such as thinner and petroleum gases) can accumulate or collect, or where volatile combustible substances are handled.**  
Corrosive gas can cause corrosion of heat exchanger, breakage of plastic parts and etc. And combustible gas can cause fire.
- **Do not use the indoor unit at the place where water splashes may occur such as in laundries.**  
Since the indoor unit is not waterproof, it can cause electric shocks and fire.
- **Do not install nor use the system close to the equipment that generates electromagnetic fields or high frequency harmonics.**  
Equipment such as Inverters, standby generators, medical high frequency equipments and telecommunication equipments can affect the system, and cause malfunctions and breakdowns. The system can also affect medical equipment and telecommunication equipment, and obstruct its function or cause jamming.
- **Do not place any variables which will be damaged by getting wet under the indoor unit.**  
When the relative humidity is higher than 80% or drainage pipe is clogged, condensation or drainage water can drop and it can cause the damage of valuables.
- **Do not install the remote control at the direct sunlight.**  
It can cause malfunction or deformation of the remote control.
- **Do not use the unit for special purposes such as storing foods, cooling precision instruments and preservation of animals, plants or art.**  
It can cause the damage of the items.
- **Do not use any materials other than a fuse with the correct rating in the location where fuses are to be used.**  
Connecting the circuit with copper wire or other metal thread can cause unit failure and fire.
- **Do not touch any buttons with wet hands.**  
It can cause electric shocks.
- **Do not touch any refrigerant pipes with your hands when the system is in operation.**  
During operation the refrigerant pipes become extremely hot or extremely cold depending the operating condition, and it can cause burn injury or frost injury.

### BEFORE INSTALLATION

○ Before installation check that the power supply matches the air conditioner.

#### Indoor unit accessories

Symbol	Part name	Units
①	Wireless remote control	1
②	Remote control holder	1
③	Wireless receiver	1
④	Installation frame (for wireless receiver)	1
⑤	Drain hose	1
⑥	Clamp (for drain hose)	1
⑦	Battery [R03 (AAA, Micro) 1.5V]	2
⑧	Large washer (for hanging bolt M8)	8
⑨	Flat head wood screw (for remote control holder $\phi$ 3.5x16)	2
⑩	Flat head machine screw (for wireless receiver M3.5x10)	2
⑪	Tapping screw (for clamp, $\phi$ 4x8)	1
⑫	Plate (display)	1

#### Option parts

Symbol	Part name	Units
Ⓐ	Blowout duct joint model RFJ22	1
Ⓑ	Drain up kit model RDU12E	1
Ⓒ	Back side suction filter set model RBF12	1
Ⓓ	Lower suction grill set model RTS12	1

#### Parts to be prepared by the operative side

Symbol	Part name	Units
Ⓐ	Drain hose	1
Ⓑ	Ceiling hanging bolts (M8)	4
Ⓒ	Nuts (M8)	8
Ⓓ	Spring lock washers (M8)	4

### Necessary tools for the installation work

- Plus headed driver
- Knife
- Saw
- Tape measure
- Hammer
- Spanner wrench
- Torque wrench [14.0 ~ 62.0 N·m (1.4 ~ 6.2 kgf·m)]
- Hole core drill (65mm in diameter)
- Wrench key (Hexagon) [4 m/m]
- Vacuum pump
- Vacuum pump adapter (Anti-reverse flow type) (Designed specifically for R410A)
- Gauge manifold (Designed specifically for R410A)
- Charge hose (Designed specifically for R410A)
- Flaring tool set (Designed specifically for R410A)
- Gas leak detector (Designed specifically for R410A)
- Gauge for projection adjustment (Used when flare is made by using conventional method)

## 1 SELECTION OF INSTALLING LOCATION

(Install the unit with the customer's consent at a location that meets the following conditions.)

### Indoor unit

- Where there are no barriers to the breeze, and where cool/hot air may diffuse throughout the room.
- A firm location that may sustain the weight of the unit, and do not cause the unit or the ceiling to vibrate.
- A location that allows room for maintenance.
- Where wiring and plumbing may be performed with ease.
- Where water may be drained easily.
- Where the unit is not influenced by the television, stereo, radio, or the lights.
- Where the unit is not influenced by high frequency equipment and wiring equipment.
- Where oil splashes do not occur frequently.
- Where sunlight and strong lights do not directly hit the receiver.
- A flat ceiling surface (bottom of ceiling).
- Where the suction inlet of the unit is located far from the air inlet on the ceiling, the entire inside of ceiling acts as an air suction duct so that the capacity is reduced at the startup. In such occasion, it is recommended to install a duct at the air suction side.
- Where the suction inlet of the unit does not match the air inlet and there is not sufficient clearance between the unit and the ceiling face, the capacity is reduced. It is necessary to enable the air suction from the back by using optional parts Ⓒ (Back side suction filter set model RBF12).

### Wireless remote control

- Where the main unit can definitely detect the signals from the wireless remote control.
- Where it is not influenced by television or stereo.
- Avoid locations with direct sunlight or around heaters.
- Do not attach to weak walls such as a mud wall.

### Maximum pipe length

The maximum lengths and height differences for the pipes differ according to their outdoor unit. Please refer the Installation Instructions for the outdoor unit.

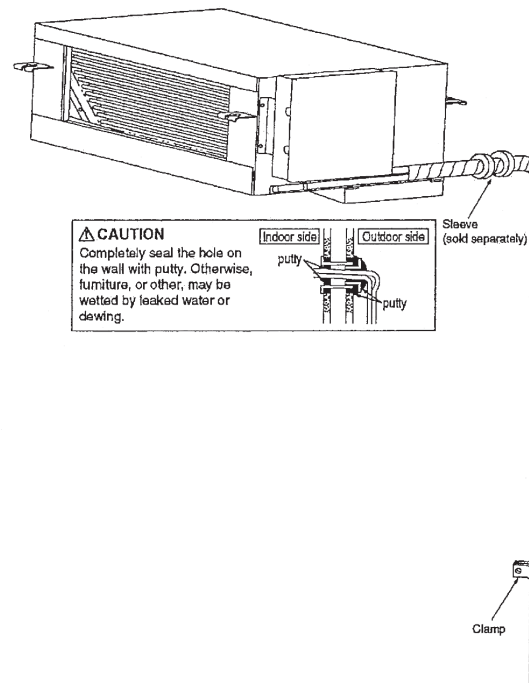

### Installation of wireless remote control

#### Mounting method of battery

- Uncover the wireless remote control, and insert the batteries (R03 (AAA, Micro) X2 pieces) in the cover. (Fit the poles with the indication mark) without fail)

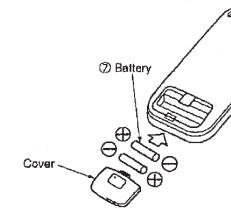

#### Fixing to pillar or wall

- Conventionally, operate the wireless remote control by holding in your hand.
- In the case of stationary operation service, mounting on the holder for the wireless remote control, that the locating place is satisfactory for access service, is recommended. Avoid installing it on a clay wall etc.

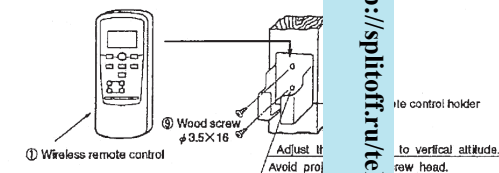

## 2 INSTALLATION OF INDOOR UNIT

### Drilling of holes in the wall and fixture of sleeve

- The connecting wires may touch the metal inside the wall and cause danger so it is necessary to always use the sleeve.

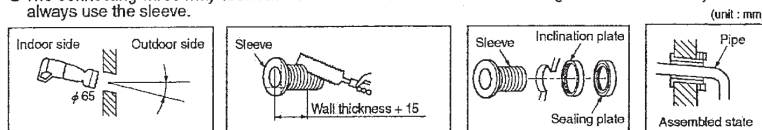

- Drill a hole with a φ65 whole core drill.
- When the pipe is connected at the rear, cut off the lower and the right side portions of the sleeve collar (as shown by the broken line).

### Preparations for the main frame

#### Mounting of interconnecting wires (Field wiring)

- ① Remove the control lid.
- ② Connect the connection wire securely to the terminal block.

Use cables for interconnection wiring to avoid loosening of the wires.

CENELEC code for cables Required field cables.

H05RN4G1.5 (Example)

- H Harmonized cable type
- 05 300/500 volts
- R Natural-and/or synth. rubber wire insulation
- N Polychloroprene rubber conductors insulation
- R Stranded core
- 4 Number of conductors
- G One conductor of the cable is the earth conductor (yellow/green)
- 1.5 Section of copper wire (mm<sup>2</sup>)

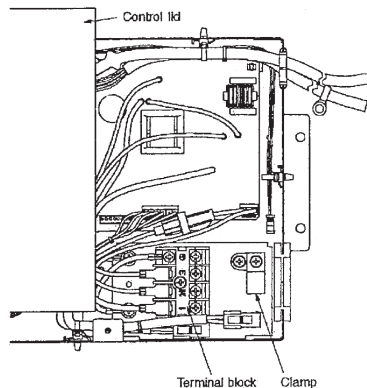

- 1) Connect the connection wire securely to the terminal block. If the wire is not affixed completely, contact will be poor, and it is dangerous as the terminal block may heat up and catch fire.
  - 2) Take care not to confuse the terminal numbers for indoor and outdoor connections.
  - 3) Affix the connection wire using the wiring clamp.
- ③ Attach the control lid.

### Installation dimensions

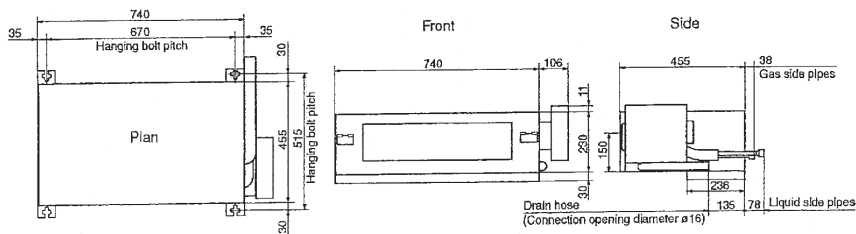

### Securing the ceiling hanging bolts

#### If steel embedded ceiling

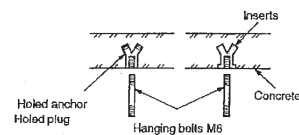

#### If wooden ceiling

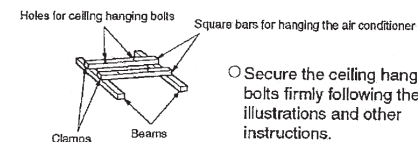

- Secure the ceiling hanging bolts firmly following the illustrations and other instructions.

### Installing the main unit

- Attach the washers and nuts to the ceiling hanging bolts.
- Attach the hanging tool to the above nuts, and tighten the nuts.

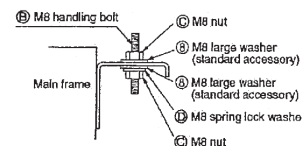

- If it is not leveled, the float switch may malfunction or may not start.

### Securing the wireless receiver

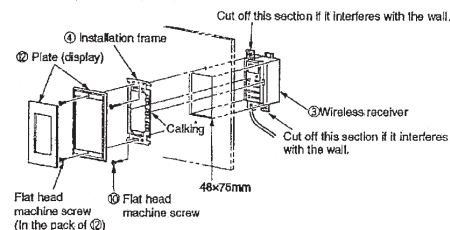

- Open a through-hole on the wall to install the reception face for the wireless receiver ③.
- Insert the wireless receiver ③ in the installation frame ④, and fix the calking section.
- Fix the installation frame ④ on the wall using the flat head machine screws ⑩.
- Fix the plate (display) ⑫ on the installation frame ④ using the flat head machine screws packed together with the plate (display) ⑫.

### About the option parts

When optional parts ① and ② are used, please remove the filter guide.

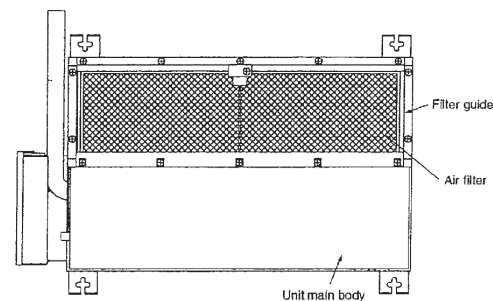



### Connecting the Drain Hose

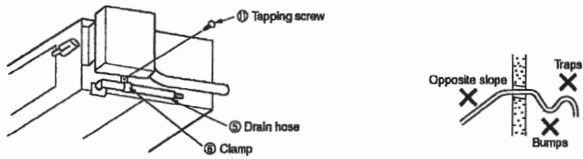

#### NOTE

Conduct the installation correctly, and ensure that the water is draining correctly. It may lead to water leaks.

- Insert the drain hose as far as possible through the lower section of the side of the unit, and secure it with clamps.
- The drain hose should be set in a downward slope (over 1/100), and it should not have any bumps or traps along its route.
- When you are obliged to route the drain hose with a trap in its way or in an ascending gradient, please use an option part Drain up kit (RDU12E) ⑤.
- The indoor drain hose must be insulated.

### 3 CONNECTION OF REFRIGERANT PIPINGS

- Regarding the change in the sizes of gas side pipes (usage of the variable joints): If the 5.0 kw and 6.0 kw class indoor units (gas side pipe 12.7) is going to be connected to the operation valves (9.52), variable joints available as accessories must be applied to the gas side operation valves.

#### [Connection of pipes]

#### NOTE

- Cover the pipes with tape so that dust and sand do not enter the pipe until they are connected.
- When connecting the pipes to the outdoor unit, be careful about the discharge of fluorocarbon gas or oil.
- Make sure to match the pipes between the indoor unit and the outdoor unit with the correct operation valves.

#### (1) Preparations

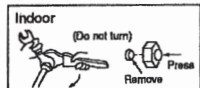

- Remove the flared nuts. (on both liquid and gas sides)

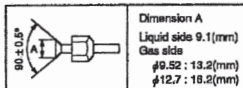

- Install the removed flared nuts to the pipes to be connected, then flare the pipes.

#### CAUTION

Do not apply refrigerating machine oil to the flared surface.

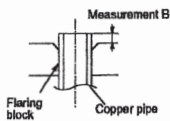

Copper pipe diameter	Measurement B (mm)		
	Clutch type flare tool for R410A	Conventional (R22) flare tool	
		Clutch type	Wing nut type
φ6.35	0.0 - 0.5	1.0 - 1.5	1.5 - 2.0
φ9.52	0.0 - 0.5	1.0 - 1.5	1.5 - 2.0
φ12.7	0.0 - 0.5	1.0 - 1.5	2.0 - 2.5

Use a flare tool designed for R410A or a conventional flare tool. Please note that measurement B (protrusion from the flaring block) will vary depending on the type of a flare tool in use. If a conventional flare tool is used, please use a copper pipe gauge or a similar instrument to check protrusion so that you can keep measurement B to a correct value.

#### (2) Connection

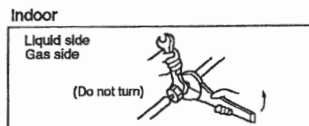

- Connect the pipes on both liquid and gas sides.
- Tighten the nuts to the following torque.  
Liquid side : 14.0 ~ 18.0 N·m (1.4 ~ 1.8 kgf·m)  
Gas side (φ 9.52) : 33.0 ~ 42.0 N·m (3.3 ~ 4.2 kgf·m)  
(φ 12.7) : 49.0 ~ 61.0 N·m (4.9 ~ 6.1 kgf·m)

### 4 HEAT INSULATION FOR JOINTS

#### Heat insulation for joints



#### Finish and fixing

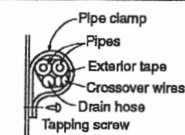

Apply exterior tape and shape along the place where the pipes will be routed. Secure to the wall with a pipe clamp. Be careful not to damage the wires.

### 5 TEST RUN AND HANDLING INSTRUCTIONS

#### Installation test check points

Check the following points again after completion of the installation, and before turning on the unit. Conduct a test run again and ensure that the unit operates properly. At the same time, explain to the customer how to use the unit and how to take care of the unit following the instruction manual. If the compressor does not operate after the operation has started, wait for 5-10 minutes. (To prevent a delayed start.)

(Three-minute restart preventive timer)

When the air conditioner is restarted or when changing the operation, the unit will not start for approximately 3 minutes. This is to protect the unit and it is not a malfunction.

#### After installation

- The power supply voltage is correct as the rating.
- No gas leaks from the joints of the operation valve.
- Power cables and crossover wires are securely fixed to the terminal board.
- Each indoor and outdoor unit is properly connected (no wrong wiring or piping).
- Operation valve is fully open.
- Refrigerant has been additionally charged (when the total pipe length exceeds the refrigerant charged pipe length).
- The pipe joints for indoor and outdoor pipes have been insulated.
- Earthing work has been conducted properly.

#### Test run

- Air conditioning and heating operation is normal.
- No abnormal noise.
- Water drains smoothly.
- Protective functions are not activated.
- Operation of the unit has been explained to the customer.
- The wireless remote control is normal.

### EARTHING WORK

- Earth work shall be carried out without fail in order to prevent electric shock and noise generation.
- The connection of the earth cable to the following substances causes dangerous failures, therefore it shall never be done. (City water pipe, Town gas pipe, TV antenna, lightning conductor, telephoneline, etc.)

### GAS LEAK DETECTION

- Check that there are no gas leaks from the pipe joints using a leak detector or soap water.

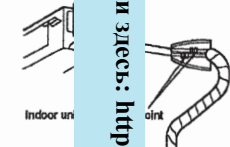

(4) Ceiling cassette-4way compact type (FDTC)

PJA012D786

This manual is for the installation of an indoor unit.  
For electrical wiring work (Indoor), refer to the electrical wiring work installation manual. For remote

Все каталоги и инструкции здесь: <http://splitoff.ru/tehn-doc.html>

### SAFETY PRECAUTIONS

● Read the "SAFETY PRECAUTIONS" carefully first of all and then strictly follow it during the installation work in order to protect yourself.

● The precautionary items mentioned below are distinguished into two levels, **WARNING** and **CAUTION**.

**WARNING**: Wrong installation would cause serious consequences such as injuries or death.

**CAUTION**: Wrong installation might cause serious consequences depending on circumstances. Both mentions the important items to protect your health and safety so strictly follow them by any means.

● The meanings of "Marks" used here are as shown as follows:

⊘ Never do it under any circumstances. ⊕ Always do it according to the instruction.

● After completing the installation, do commissioning to confirm there are no abnormalities, and explain to the customers about "SAFETY PRECAUTIONS", correct operation method and maintenance method (air filter cleaning, operation method and temperature setting method) with user's manual of this unit. Ask your customers to keep this installation manual together with the user's manual. Also, ask them to hand over the user's manual to the new user when the owner is changed.

---

### WARNING

- **Installation should be performed by the specialist.**  
If you install the unit by yourself, it may lead to serious trouble such as water leakage, electric shock, fire, and injury due to overturn of the unit.
- **Install the system correctly according to these installation manuals.**  
Improper installation may cause explosion, injury, water leakage, electric shock, and fire.
- **When installing in small rooms, take prevention measures not to exceed the density limit of refrigerant in the event of leakage, referred by the formula (accordance with ISO5149).**  
If the density of refrigerant exceeds the limit, please consult the dealer and install the ventilation system, otherwise lack of oxygen can occur, which can cause serious accidents.
- **Use the genuine accessories and the specified parts for installation.**  
If parts unspecified by our company are used it could cause water leakage, electric shock, fire, and injury due to overturn of the unit.
- **Ventilate the working area well in case the refrigerant leaks during installation.**  
If the refrigerant contacts the fire, toxic gas is produced.
- **Install the unit in a location that can hold heavy weight.**  
Improper installation may cause the unit to fall leading to accidents.
- **Install the unit properly in order to be able to withstand strong winds such as typhoons, and earthquakes.**  
Improper installation may cause the unit to fall leading to accidents.
- **Do not mix air in to the cooling cycle on installation or removal of the air conditioner.**  
If air is mixed in, the pressure in the cooling cycle will rise abnormally and may cause explosion and injuries.
- **Be sure to have the electrical wiring work done by qualified electrical installer, and use exclusive circuit.**  
Power source with insufficient capacity and improper work can cause electric shock and fire.
- **Use specified wire for electrical wiring, fasten the wiring to the terminal securely, and hold the cable securely in order not to apply unexpected stress on the terminal.**  
Loose connections or hold could result in abnormal heat generation or fire.
- **Arrange the electrical wires in the control box properly to prevent them from rising. Fit the lid of the services panel properly.**  
Improper fitting may cause abnormal heat and fire.
- **Check for refrigerant gas leakage after installation is completed.**  
If the refrigerant gas leaks into the house and comes in contact with a fan heater, a stove, or an oven, toxic gas is produced.
- **Use the specified pipe, flare nut, and tools for R410A.**  
Using existing parts (R22) could cause the unit failure and serious accident due to explosion of the cooling cycle.
- **Tighten the flare nut according to the specified method by with torque wrench.**  
If the flare nut were tightened with excess torque, it could cause burst and refrigerant leakage after a long period.
- **Do not put the drainage pipe directly into drainage channels where poisonous gases such as sulfide gas can occur.**  
Poisonous gases will flow into the room through drainage pipe and seriously affect the user's health and safety. This can also cause the corrosion of the indoor unit and a resultant unit failure or refrigerant leak.
- **Connect the pipes for refrigeration circuit securely in installation work before compressor is operated.**  
If the compressor is operated when the service valve is open without connecting the pipe, it could cause explosion and injuries due to abnormal high pressure in the system.
- **Stop the compressor before removing the pipe after shutting the service valve on pump down work.**  
If the pipe is removed when the compressor is in operation with the service valve open, air would be mixed in the refrigeration circuit and it could cause explosion and injuries due to abnormal high pressure in the cooling cycle.
- **Only use prescribed optional parts. The installation must be carried out by the qualified installer.**  
If you install the system by yourself, it can cause serious trouble such as water leaks, electric shocks, fire.
- **Do not repair by yourself. And consult with the dealer about repair.**  
Improper repair may cause water leakage, electric shock or fire.
- **Consult the dealer or a specialist about removal of the air conditioner.**  
Improper installation may cause water leakage, electric shock or fire.
- **Turn off the power source during servicing or inspection work.**  
If the power is supplied during servicing or inspection work, it could cause electric shock and injury by the operating fan.
- **Do not run the unit when the panel or protection guard are taken off.**  
Touching the rotating equipment, hot surface, or high voltage section could cause an injury to be caught in the machine, to get burned, or electric shock.
- **Shut off the power before electrical wiring work.**  
It could cause electric shock, unit failure and improper running.

### CAUTION

Improper earth could

- **Earth leakage breaker must be installed.**  
If the earth leakage breaker is not installed, it can cause electric shocks.
- **Use the circuit breaker of correct capacity. Circuit breaker should be the one that disconnect all poles under over current.**  
Using the incorrect one could cause the system failure and fire.
- **Do not use any materials other than a fuse of correct capacity where a fuse should be used.**  
Connecting the circuit by wire or copper wire could cause unit failure and fire.
- **Do not install the indoor unit near the location where there is possibility of flammable gas leakages.**  
If the gas leaks and gathers around the unit, it could cause fire.
- **Do not install and use the unit where corrosive gas (such as sulfurous acid gas etc.) or flammable gas (such as thinner, petroleum etc.) may be generated or accumulated, or volatile flammable substances are handled.**  
It could cause the corrosion of heat exchanger, breakage of plastic parts etc. And inflammable gas could cause fire.
- **Secure a space for installation, inspection and maintenance specified in the manual.**  
Insufficient space can result in accident such as personal injury due to falling from the installation place.
- **Do not use the indoor unit at the place where water splashes such as laundry.**  
Indoor unit is not waterproof. It could cause electric shock and fire.
- **Do not use the indoor unit for a special purpose such as food storage, cooling for precision instrument, preservation of animals, plants, and a work of art.**  
It could cause the damage of the items.
- **Do not install nor use the system near equipments which generate electromagnetic wave or high harmonics.**  
Equipments like inverter equipment, private power generator, high-frequency medical equipment, or telecommunication equipment might influence the air conditioner and cause a malfunction and breakdown. Or the air conditioner might influence medical equipments or telecommunication equipments, and obstruct their medical activity or cause jamming.
- **Do not install the remote controller at the direct sunlight.**  
It could cause breakdown or deformation of the remote controller.
- **Do not install the indoor unit at the place listed below.**
  - Places where flammable gas could leak.
  - Places where carbon fiber, metal powder or any powder is floated.
  - Place where the substances which affect the air conditioner are generated such as sulfide gas, chloride gas, acid, alkali or ammoniac atmospheres.
  - Places exposed to oil mist or steam directly.
  - On vehicles and ships
  - Places where machinery which generates high harmonics is used.
  - Places where cosmetics or special sprays are frequently used.
  - Highly salted area such as beach.
  - Heavy snow area
  - Places where the system is affected by smoke from a chimney.
  - Altitude over 1000m
- **Do not install the indoor unit in the locations listed below (Be sure to install the indoor unit according to the installation manual for each model because each indoor unit has each limitation)**
  - Locations with any obstacles which can prevent inlet and outlet air of the unit
  - Locations where vibration can be amplified due to insufficient strength of structure.
  - Locations where the infrared receiver is exposed to the direct sunlight or the strong light beam. (in case of the infrared specification unit)
  - Locations where an equipment affected by high harmonics is placed. (TV set or radio receiver is placed within 5m)
  - Locations where drainage cannot run off safely.
  - It can affect performance or function and etc.
- **Do not put any valuables which will break down by getting wet under the air conditioner.**  
Condensation could drop when the relative humidity is higher than 80% or drain pipe is clogged, and it damages user's belongings.
- **Do not use the base frame for the outdoor unit which is corroded or damaged after a long period of use.**  
It could cause the unit falling down and injury.
- **Pay attention not to damage the drain pan by weld sputter when brazing work is done near the unit.**  
If sputter entered into the unit during brazing work, it could cause damage (pinhole) of drain pan and leakage of water. To avoid damaging, keep the indoor unit packed or cover the indoor unit.
- **Install the drain pipe to drain the water surely according to the installation manual.**  
Improper connection of the drain pipe may cause dropping water into room and damaging user's belongings.
- **Do not share the drain pipe for indoor unit and GHP (Gas Heat Pump system) outdoor unit.**  
Toxic exhaust gas would flow into room and it might cause serious damage (some poisoning or deficiency of oxygen) to user's health and safety.
- **Be sure to perform air tightness test by pressurizing with nitrogen gas after completed refrigerant piping work.**  
If the density of refrigerant exceeds the limit in the event of refrigerant leakage in the small room, lack of oxygen can occur, which can cause serious accidents.
- **For drain pipe installation, be sure to make descending slope of greater than 1/100, not to make traps, and not to make air-bleeding.**  
Check if the drainage is correctly done during commissioning and ensure the space for inspection and maintenance.
- **Ensure the insulation on the pipes for refrigeration circuit so as not to condense water.**  
Incomplete insulation could cause condensation and it would wet ceiling, floor, and any other valuables.
- **Do not install the outdoor unit where is likely to be a nest for insects and small animals.**  
Insects and small animals could come into the electronic components and cause breakdown and fire. Instruct the user to keep the surroundings clean.
- **Pay extra attention, carrying the unit by hand.**  
Carry the unit with 2 people if it is heavier than 20kg. Do not use the plastic straps but the grabbing place, moving the unit by hand. Use protective gloves in order to avoid injury by the aluminum fin.
- **Make sure to dispose of the packaging material.**  
Leaving the materials may cause injury as metals like nail and woods are used in the package.
- **Do not operate the system without the air filter.**  
It may cause the breakdown of the system due to clogging of the heat exchanger.
- **Do not touch any button with wet hands.**  
It could cause electric shock.
- **Do not touch the refrigerant piping with bare hands when in operation.**  
The pipe during operation would become very hot or cold according to the operating condition, and it could cause a burn or frostbite.
- **Do not clean up the air conditioner with water.**  
It could cause electric shock.
- **Do not turn off the power source immediately after stopping the operation.**  
Be sure to wait for more than 5 minutes. Otherwise it could cause water leakage or breakdown.
- **Do not control the operation with the circuit breaker.**  
It could cause fire or water leakage. In addition, the fan may start operation unexpectedly and it may cause injury.

### 1 Before installation

- Install correctly according to the installation manual.
- Confirm the following points:
  - Unit type/Power supply specification
  - Pipes/Wires/Small parts
  - Accessory items

Все каталоги и инструкции здесь: <http://splitoff.ru/tehn-doc.html>

8	4	1	1	4	1	1	1	1
For unit hanging	For adjustment in hoisting in the unit's main body	For heat insulation of gas pipe	For heat insulation of liquid tube	For pipe cover fixing	For heat insulation of drain socket	For heat insulation of drain socket	For drain pipe connecting	For drain hose mounting

### 2 Selection of installation location for the indoor unit

- Select the suitable areas to install the unit under approval of the user.
  - Areas where the indoor unit can deliver hot and cold wind sufficiently. Suggest to the user to use a circulator if the ceiling height is over 3m to avoid warm air being accumulated on the ceiling.
  - Areas where there is enough space to install and service.
  - Areas where it can be drained properly. Areas where drain pipe descending slope can be taken.
  - Areas where there is no obstruction of airflow on both air return grille and air supply port.
  - Areas where fire alarm will not be accidentally activated by the air conditioner.
  - Areas where the supply air does not short-circuit.
  - Areas where it is not influenced by draft air.
  - Areas not exposed to direct sunlight.
  - Areas where dew point is lower than around 28°C and relative humidity is lower than 80%.  
 (This indoor unit is tested under the condition of JIS (Japan Industrial Standard) high humidity condition and confirmed there is no problem. However, there is some risk of condensation drop if the air conditioner is operated under the severer condition than mentioned above. If there is a possibility to use it under such a condition, attach additional insulation of 10 to 20mm thick for entire surface of indoor unit, refrigeration pipe and drain pipe.)
  - Areas where TV and radio stays away more than 1m. (It could cause jamming and noise.)
  - Areas where any items which will be damaged by getting wet are not placed such as food, table wares, server, or medical equipment under the unit.
  - Areas where there is no influence by the heat which cookware generates.
  - Areas where not exposed to oil mist, powder and/or steam directly such as above fryer.
  - Areas where lighting device such as fluorescent light or incandescent light doesn't affect the operation.  
 (A beam from lighting device sometimes affects the infrared receiver for the wireless remote controller and the air conditioner might not work properly.)
- Check if the place where the air conditioner is installed can hold the weight of the unit. If it is not able to hold, reinforce the structure with boards and beams strong enough to hold it. If the strength is not enough, it could cause injury due to unit falling.
- If there are 2 units of wireless type, keep them away for more than 5m to avoid malfunction due to cross communication.
- When plural indoor units are installed nearby, keep them away for more than 4m.

#### Space for installation and service

- When it is not possible to keep enough space between indoor unit and wall or between indoor units, close the air supply port where it is not possible to keep space and confirm there is no short circuit of airflow.
- Install the indoor unit at a height of more than 2.5m above the floor.

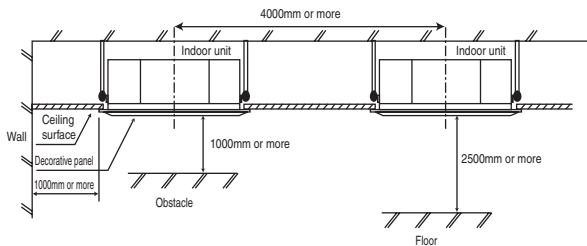

### 3 Preparation before installation

- If suspension bolt becomes longer, do reinforcement of earthquake resistant.
  - For grid ceiling  
When suspension bolt length is over 500mm, or the gap between the ceiling and roof is over 700mm, apply earthquake resistant brace to the bolt.

- Prepare four (4) sets of suspension bolt, nut and spring washer (M10 or M8) on site.

#### Ceiling opening, Suspension bolts pitch, Pipe position

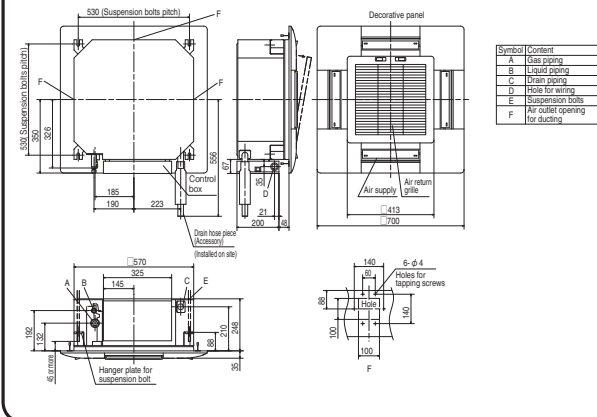

### 4 Installation of indoor unit

#### Work procedure

- This unit is designed for 2 x 2 grid ceiling. If necessary, please detach the T bar temporarily before you install it. If it is installed on a ceiling other than 2 x 2 grid ceiling, provide an inspection port on the control box side.
- Arrange the suspension bolt at the right position (530mm×530mm).
- Make sure to use four suspension bolts and fix them so as to be able to hold 500N load.
- Ensure that the lower end of the suspension bolt should be 45mm above the ceiling plane. Temporarily put the four lower nuts 88mm above the ceiling plane and the upper nuts at distant place from the lower nuts in order not to obstruct hanging the indoor unit or adjust the indoor unit position, and then hang the indoor unit.

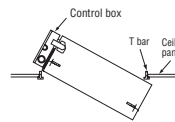

- Adjust the indoor unit position after hanging it by inserting the level gauge attached on the package into the air supply port and checking if the gap between the ceiling plane and the indoor unit is appropriate. In order to adjust the indoor unit position, adjust the lower nuts while the upper nuts are put on distant place. Confirm there is no backlash between the hanger plate for suspension bolt and the lower nut and washer.

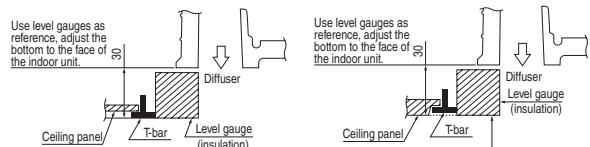
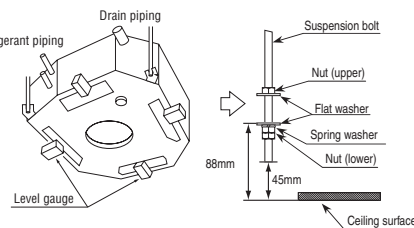

When the ceiling panel comes below the T bar, align the bottom of the level gauge to the lower face of the ceiling panel.

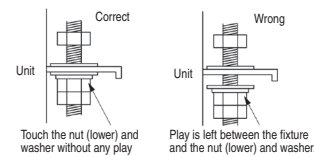



#### ④ Installation of indoor unit (continued)

6. Make sure to install the indoor unit horizontally. Confirm the levelness of the indoor unit with a level gauge or transparent hose filled with water. Keep the height difference at both ends of the indoor unit within 3mm.
7. Tighten four upper nuts and fix the unit after height and levelness

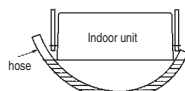

Все каталоги и инструкции здесь: <http://splitoff.ru/tehn-doc.html>

- Do not adjust the height by adjusting upper nuts. It will cause unexpected stress on the indoor unit and it will lead to deformation of the unit, failure of attaching a panel, and generating noise from the fan.
- Make sure to install the indoor unit horizontally and set the gap between the unit underside and the ceiling plane properly. Improper installation may cause air leakage, dew condensation, water leakage and noise.
- Even after decorative panel attached, still the unit height can be adjusted finely. Refer to the installation manual for decorative panel for details.
- Make sure there is no gap between decoration panel and ceiling surface, and between decoration panel and the indoor unit. The gap may cause air leakage, dew condensation and water leakage.
- In case decorative panel is not installed at the same time, or ceiling material is installed after the unit installed, put the cardboard template for installation attached on the package (packing material of cardboard box) on the bottom of the unit in order to avoid dust coming into the indoor unit.

#### ⑤ Refrigerant pipe

##### Caution

- Use the new refrigerant pipe.
  - When re-using the existing pipe system for R22 or R407C, pay attention to the following items.
    - Change the flare nuts with the attached ones (JIS category 2), and reprocess the flare parts.
    - Do not use thin-walled pipes.
- Use phosphorus deoxidized copper alloy seamless pipe (C1220T specified in JIS H3300) for refrigeration pipe installation.
  - In addition, make sure there is no damage both inside and outside of the pipe, and no harmful substances such as sulfur, oxide, dust or a contaminant stuck on the pipes.
- Do not use any refrigerant other than R410A.
  - Using other refrigerant except R410A (R22 etc.) may degrade inside refrigeration oil. And air getting into refrigeration circuit may cause over-pressure and resultant it may result in bursting, etc.
- Store the copper pipes indoors and seal the both end of them until they are brazed in order to avoid any dust, dirt or water getting into pipe. Otherwise it will cause degradation of refrigeration oil and compressor breakdown, etc.
- Use special tools for R410 refrigerant.

##### Work procedure

1. Remove the flare nut and blind flanges on the pipe of the indoor unit.
  - Make sure to loosen the flare nut with holding the nut on pipe side with a spanner and giving torque to the nut with another spanner in order to avoid unexpected stress to the copper pipe, and then remove them.
    - (Gas may come out at this time, but it is not abnormal.)
    - Pay attention whether the flare nut pops out. (as the indoor unit is sometimes pressured.)
2. Make a flare on liquid pipe and gas pipe, and connect the refrigeration pipes on the indoor unit.
  - Bend the pipe with as big radius as possible and do not bend the pipe repeatedly. In addition, do not twist and crush the pipes.
  - Do a flare connection as follows:
    - Make sure to loosen the flare nut with holding the nut on pipe side with a spanner and giving torque to the nut with another spanner in order to avoid unexpected stress to the copper pipe, and then remove them.
    - When fastening the flare nut, align the refrigeration pipe with the center of flare nut, screw the nut for 3-4 times by hand and then tighten it by spanner with the specified torque mentioned in the table below. Make sure to hold the pipe on the indoor unit securely by a spanner when tightening the nut in order to avoid unexpected stress on the copper pipe.
3. Cover the flare connection part of the indoor unit with attached insulation material after a gas leakage inspection, and tighten both ends with attached straps.
  - Make sure to insulate both gas pipes and liquid pipes completely.
    - Incomplete insulation may cause dew condensation or water dropping.
4. Refrigerant is charged in the outdoor unit.
  - As for the additional refrigerant charge for the indoor unit and piping, refer to the installation manual attached to the outdoor unit.

Pipe diameter	Tightening torque N·m
φ 6.35	14 to 18
φ 9.52	34 to 42
φ 12.7	49 to 61
φ 15.88	68 to 82
φ 19.05	100 to 120

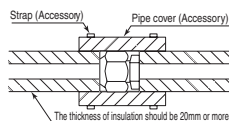

#### ⑥ Drain pipe

##### Caution

- Install the drain pipe according to the installation manual in order to drain properly. Imperfection in draining may cause flood indoors and wetting the household goodset.
- Do not put the drain pipe directly into the ditch where toxic gas such as sulfur, the other harmful and inflammable gas is generated. Toxic gas would flow into the room and it would cause serious damage to user's health and safety (some poisoning or deficiency of oxygen). In addition, it may cause corrosion of heat exchanger and bad smell.
- Connect the pipe securely to avoid water leakage from the joint.
- Insulate the pipe properly to avoid condensation drop.
- Check if the water can flow out properly from both the drain outlet on the indoor unit and the end of the drain pipe after installation.
- Make sure to make descending slope of greater than 1/100 and do not make up-down bend and/or trap in the midway. In addition, do not put air vent on the drain pipe. Check if water is drained out properly from the pipe during commissioning. Also, keep sufficient space for inspection and maintenance.

#### ⑥ Drain pipe (continued)

##### Work procedure

1. Make sure to insert the drain hose (the end mode of soft PVC) to the end of the step part of drain socket.
  - Attach the hose clamp to the drain hose around 10mm from the end, and fasten the screw within 5mm left to the nut.

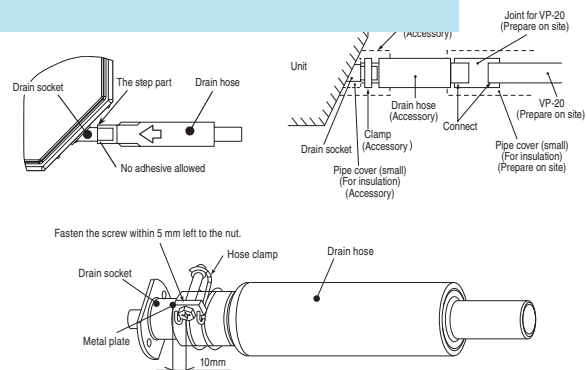

2. Prepare a joint for connecting VP-20 pipe, adhere and connect the joint to the drain hose (the end made of rigid PVC), and adhere and connect VP-20 pipe (prepare on site).
  - As for drain pipe, apply VP-20 made of rigid PVC which is on the market.
    - Make sure that the adhesive will not get into the supplied drain hose. It may cause the flexible part broken after the adhesive is dried up and gets rigid.
    - Do not bend or make an excess offset on the drain hose as shown in the picture. Bend or excess offset will cause drain leakage.

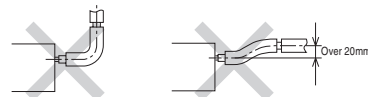

3. Make sure to make descending slope of greater than 1/100 and do not make up-down bend and/or trap in the midway.
  - Pay attention not to give stress on the pipe on the indoor unit side, and support and fix the pipe as close place to the unit as possible when connecting the drain pipe.
  - Do not set up air vent.

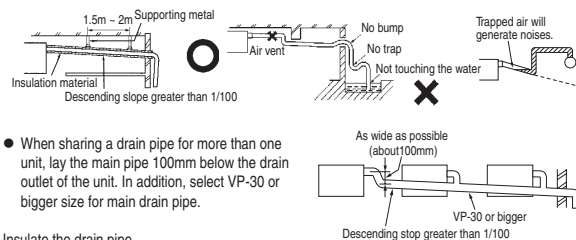

4. Insulate the drain pipe.
  - Be sure to insulate the drain socket and rigid PVC pipe installed indoors otherwise it may cause dew condensation and water leakage.
    - After drainage test implementation, cover the drain socket part with pipe cover (small size), then use the pipe cover (big size) to cover the pipe cover (small size), clamps and part of the drain hose, and fix and wrap it with tapes to wrap and make joint part gapless.

##### Drain up

- The position for drain pipe outlet can be raised up to 600mm above the ceiling. Use elbows for installation to avoid obstacles inside ceiling. If the horizontal drain pipe is too long before vertical pipe, the backflow of water will increase when the unit is stopped, and it may cause overflow of water from the drain pan on the indoor unit. In order to avoid overflow, keep the horizontal pipe length and offset of the pipe within the limit shown in the figure below.

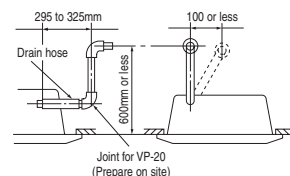

**⑥ Drain pipe (continued)**

**Drain test**

- After installation of drain pipe, make sure that drain system work in good condition and no water leakage from joint and drain pan. Check if the motor sound of drain pump is normal or not.
- Do drain test even if installation of heating season.
- For new building cases, make sure to complete the test before

Все каталоги и инструкции здесь: <http://splitoff.ru/tehn-doc.html>

2. Make sure that water is drained out properly and there is no water leakage from any joints of the drain pipe at the test. Confirm that the water is properly drained out while the drain motor is operating. At the drain socket (transparent), it is possible to check if the water is drained out properly.
3. Unplug the drain plug on the indoor unit to remove remaining water on the drain pan after the test, and re-plug it. And insulate the drain pipe properly finally.

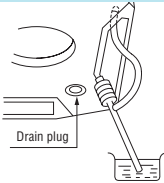

**Drain pump operation**

- In case electrical wiring work finished  
Drain pump can be operated by remote controller (wired).  
For the operation method, refer to [Operation for drain pump] in the installation manual for wiring work.
- In case electrical wiring work not finished  
Drain pump will run continuously when the dip switch "SW7-1" on the indoor unit PCB is turned ON, the Connector CNB is disconnected, and then the power supply (220-240VAC on the terminal block [ ① and ② ] or [ L and N ] ) is turned ON.  
Make sure to turn OFF "SW7-1" and reconnect the Connector CNB after the test.

**⑦ Wiring-out position and wiring connection**

- Electrical installation work must be performed according to the installation manual by an electrical installation service provider qualified by a power provider of the country, and be executed according to the technical standards and other regulations applicable to electrical installation in the country. Be sure to use an exclusive circuit.
- Use specified cord, fasten the wiring to the terminal securely, and hold the cord securely in order not to apply unexpected stress on the terminal.
- Do not put both power source line and signal line on the same route. It may cause miscommunication and malfunction.
- Be sure to do D type earth work.
- For the details of electrical wiring work, see attached instruction manual for electrical wiring work.

1. Remove a lid of the control box (1 screws).
2. Hold each wiring inside the unit and fasten them to terminal block securely.
3. Fix the wiring with clamp.
4. Install a lid of the control box back to original place.

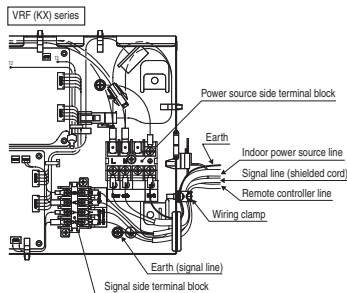
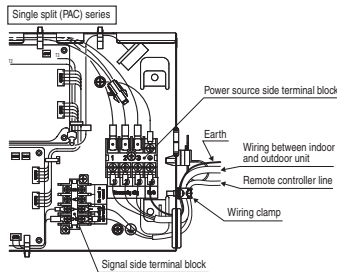

**⑧ Panel installation**

- After wiring work finished, install the panel on the indoor unit.
- Refer to attached panel installation manual for details.

**Accessory items**

3	Bolt		4 pieces	For installing the panel
4	Screw		1 piece	For attaching a hook
5	Screw		2 pieces	For attaching a chain

- Attach the panel on the indoor unit after electrical wiring work.
- Refer to attached manual for panel installation for details. (See next page)

**⑨ Check list after installation**

- Check the following items after all installation work completed.

Check if	Expected trouble	Check
The indoor and outdoor units are fixed securely?	Falling, vibration, noise	
Inspection for leakage is done?	Insufficient capacity	
Insulation work is properly done?	Water leakage	
Water is drained properly?	Water leakage	
Supply voltage is same as mentioned in the model name plate?	PCB burnt out, not working at all	
There is mis-wiring or mis-connection of piping?	PCB burnt out, not working at all	
Earth wiring is connected properly?	Electric shock	
Cable size comply with specified size?	PCB burnt out, not working at all	
Any obstacle blocks airflow on air inlet and outlet?	Insufficient capacity	

# PANEL INSTALLATION MANUAL

PJA012D783

Please read this manual together with the indoor unit's installation manual.

## ⚠ WARNING

Все каталоги и инструкции здесь: <http://splitoff.ru/tehn-doc.html>

- Make sure the power supply is turned off when electric wiring work. Otherwise, electric shock, malfunction and improper running may occur.



### ① Checking the indoor unit installation position

- Read this manual together with the air conditioner installation manual carefully.
- Check if the gap between the ceiling plane and the indoor unit is correct by inserting the level gauge into the air outlet port of the indoor unit. (See below drawing)
- Adjust the installation elevation if necessary.
- Remove the level gauge before you attach the panel.

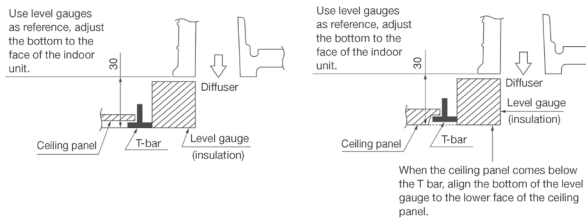

### ② Orientation of the panel and return air grille installation

- Take note that there is an orientation to install the panel.
  - Attach the panel with the orientation shown on the below.
  - Align the "PIPE SIDE" mark (on the panel) with the refrigerant pipes on the indoor unit.
- The intake grille can also be attached in a rotated position by 90 degrees.

**Caution**  
 In case the orientation of the panel is not correct, it will lead to air leakage and also it is not possible to connect the louver motor wiring.

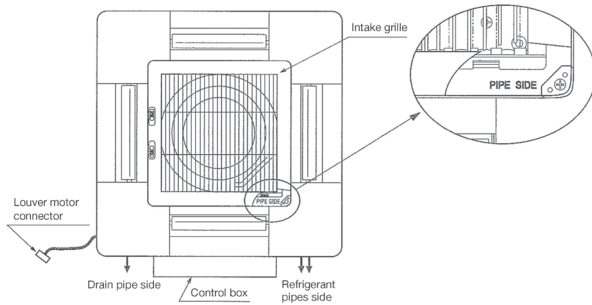

### ③ Removing a corner panel

- Unscrew the screw from the corner area, pull the corner panel toward the direction indicated by the arrow mark.

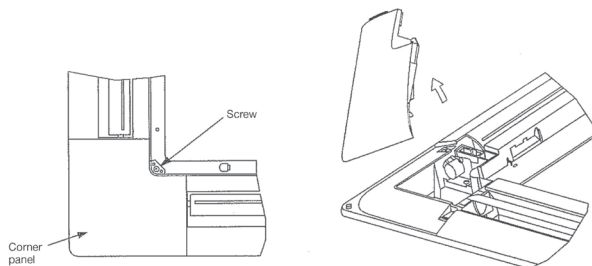

hooks and tighten the screw.

panel, engage two

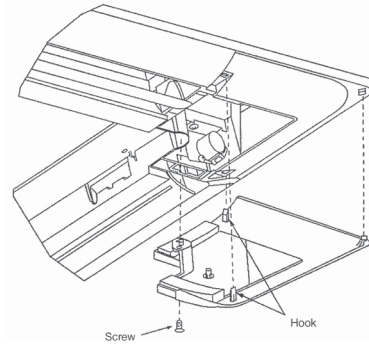

### ⑤ Panel installation

- Install the panel on the unit after completing the electrical wiring.

#### Accessories

No.	Part Name	Quantity	Use
1	Hook	1 piece	For fixing temporarily
2	Chain	2 pieces	
3	Screw	4 pieces	For hoisting the panel
4	Screw	1 piece	For attaching a hook
5	Screw	2 pieces	For attaching a chain

- Screw in two bolts out of the four supplied with the panel by about slightly less than 5mm. (● mark (A) (B)) [Figure 1]

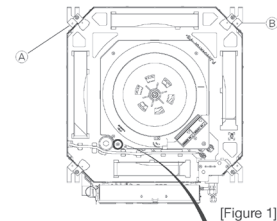

- Attach the hook supplied with the panel to the main body with the hook fixing screw (1 screw). [Figure 2]

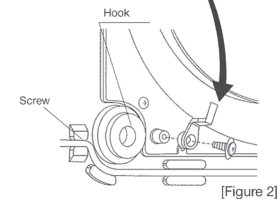

- Open the intake grille.

- Please remove the screw of a corner panel and remove a corner panel. (four places)

- A panel is hooked on two bolts (● mark (A) (B)). [Figure 3]

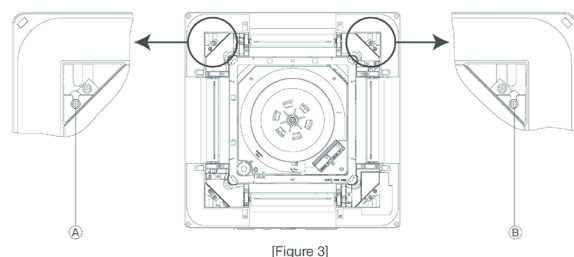

6. Please rotate a hook, put in the slot on the panel, and carry out fixing the panel temporarily. [Figure 4]



[Figure 4]

7. Tighten the two bolts used for fixing the panel temporarily and the other two.

**Caution**

- Improperly tightened hanging bolts can cause the problems listed below, so make sure that you have tightened them securely.
- If there is a gap remaining between the ceiling and the decorative panel even after the hanging bolts are tightened, adjust the installation level of the indoor unit again.

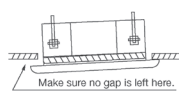
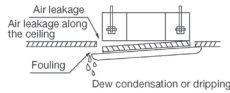

8. Please open the lid of a control box.  
 9. Like drain pump wiring, please band together by the clamp and put in louver motor wiring into a control box. [Figure 5]  
 10. Please connect a louver motor connector. [Figure 5]

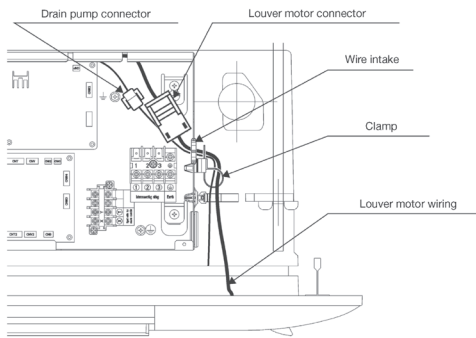

[Figure 5]

11. Attach two chains to the intake grille with two screws. [Figure 6]

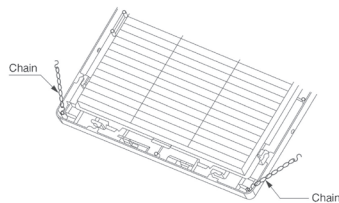

[Figure 6]

12. Replace the corner panels. Please also close a chain with a screw together then. [Figure 7]  
 13. Close the intake grill.

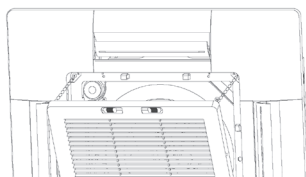

[Figure 7]

**Caution**

Make sure there is no stress given on the panel when adjusting the height of the indoor unit to avoid unexpected distortion. It may cause the distortion of panel or failing to close the air return grille.

**⑦ How to set the airflow direction**

It is possible to change the movable range of the louver on the air outlet from the wired remote controller. Once the top and bottom position is set, the louver will swing within the range between the top and the bottom when swing operation is chosen. It is also possible to apply different setting to each louver.  
 Note: This function is not able to be set with wireless remote controller or simple remote control(RCH - H3).

1 Stop the air conditioner and press **SET** button and

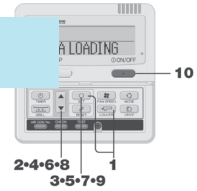

10

The following is displayed if the number of the indoor units connected to the remote controller are more than one

\*E+ SELECT I/O  
 \*1/0000

2 Press **▲** or **▼** button. (selection of indoor unit)

Select the indoor unit of which the louver is set.

[EXAMPLE]  
 \*1/0000    ▲→\*1/0001    ▼→\*1/0002    ◀→  
 \*1/0003    ▶

3 Press **SET** button. (determination of indoor unit)

Selected indoor unit is fixed.

[EXAMPLE]  
 \*1/0001 (displayed for two seconds)  
 \*DATA LOADING \*  
 \*No.1

**NOTICE**

In case the louver No is uncertain, set any louver temporarily. The louver will swing once when the setting is completed and it is possible to confirm the louver No and the position. After that, choose the correct louver No and set the top and bottom position.

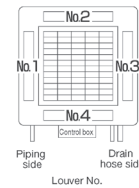

4 Press **▲** or **▼** button. (selection of louver No.)

Select the louver No. to be set according to the right figure.

[EXAMPLE]  
 \*No.1    ▲→\*No.2    ▼→\*No.3    ◀→  
 \*No.4    ▶

5 Press **SET** button. (Determination of louver No.)

The louver No. to be set is confirmed and the display shows the upper limit of the movable range.

[EXAMPLE] If No. louver is selected  
 \*No.1 UPPER2    ◀→ current upper limit position

6 Press **▲** or **▼** button. (selection of upper limit position)

Select the upper limit of louver movable range. "position 1" is the most horizontal, and "position 6" is the most downward. "position --" is to return to the factory setting. If you need to change the setting to the default setting, use "position --".

\*No.1 UPPER1    ▼ (the most horizontal)  
 \*No.1 UPPER2    ◀  
 \*No.1 UPPER3    ◀  
 \*No.1 UPPER4    ◀  
 \*No.1 UPPE5    ◀  
 \*No.1 UPPE6    ◀ (the most downwards)  
 \*No.1 UPPE7    ◀ (return to the default setting)

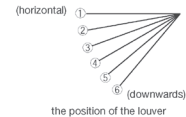

7 Press **SET** button. (i in of the upper limit position)

The upper limit position is fixed and the setting position is displayed for two seconds. Then proceed to lower limit position selection display.

[EXAMPLE]  
 \*No.1 LOWER5    (displayed for two seconds)  
 \*No.1 LOWER5    ◀ (shows current setting)

8 Press **▲** or **▼** button. (Selection of lower limit position)

Select the lower limit position of louver. "position 1" is the most horizontal, and "position 6" is the most downwards. "position --" is to return to the factory setting. If you need to change the setting to the default setting, use "position --".

\*No.1 LOWER1    ▼ (the most horizontal)  
 \*No.1 LOWER2    ◀  
 \*No.1 LOWER3    ◀  
 \*No.1 LOWER4    ◀  
 \*No.1 LOWER5    ◀ (the most downwards)  
 \*No.1 LOWER6    ◀ (return to the default setting)

9 Press **SET** button. (i in of the lower limit position)

Upper limit position and lower limit position are fixed, and the set positions are displayed for two seconds, then setting is completed.  
 After the setting is completed, the louver which was set moves from the original position to the lower limit position, and goes back to the original position again. (This operation is not performed if the indoor unit and/or outdoor unit fan is in operation.)

[EXAMPLE]  
 \*No.1 U2 L5    (displayed for two seconds)  
 SET COMPLETE  
 \*No.1

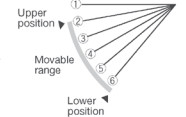

10 Press **ON/OFF** button.

Louver adjusting mode ends and returns to the original display. For setting the swing range of other louvers, return to 1 and proceed same procedure respectively.

**Caution**

If the upper limit position number and the lower limit position number are set to the same position, the louver is fixed at that position auto swing does not function.

**ATTENTION**

If you press **RESET** button during settings, the display will return to previous display. If you press **ON/OFF** button during settings, the mode will be ended and return to original display, and the settings that have not been completed will become invalid.

When plural remote controllers are connected, louver setting operation cannot be set by slave remote controller.

If it is necessary to fix the louver position manually, follow the procedure mentioned below.

- Shut off the main power switch.
- Unplug the connector of the louver motor which you want to fix the position. Make sure to insulate unplugged connectors electrically with a vinyl tape.
- Adjust the louver position slowly by hand so as to be within the applicable range mentioned below table.

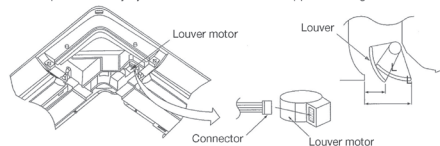

<Range of louver setting>

Vertical airflow direction	Horizontal 23° Downwards 50°
Dimension L (mm)	40                      24

※It can be set between 24-40mm freely.

**Caution**

Any automatic control or operation from the remote controller will be disabled on the louver whose position is fixed in the above way.  
 Do not set a louver beyond the specified range. Failure to observe this instruction may result in dripping, dew condensation, the fouling of the ceiling and the malfunctioning of the unit.



---

Air-Conditioning & Refrigeration Systems Headquarters  
16-5, 2-chome, Kounan, Minato-ku, Tokyo, 108-8215, Japan  
Fax : (03) 6716-5926

Because of our policy of continuous improvement, we reserve the right to make changes in all specifications without notice.

© Copyright MITSUBISHI HEAVY INDUSTRIES, LTD.



**Большая библиотека технической документации**  
**<http://splitoff.ru/tehn-doc.html>**  
**каталоги, инструкции, сервисные мануалы, схемы.**